

Large Area Light: Bolt-Line

3-CCT & 5-Power Selectable



Detail Specifications:

- Finish: Bronze
 - Custom colors available
- IP Rating: Wet Location (IP65)
- Beam Angle: Type III Installed (Type II, IV, V available)
- CCT: 30/40/50K Selectable
- Chip: SMD 2835, R9 >50, CRI >80
- Operating Temperature: -40° - 122° F
- Lens: PC Lens: Clear acrylic with optics
- Average life (L70) of 70,000 hours

Applications:

- Dock and Loading
- Walkways & Pathways
- Parking Lots
- Outdoor Corridors
- General Outdoor Lighting
- Commercial and Industrial

Product Information:

- Sturdy die-cast aluminum housing finished with corrosion free powder coat
- 2' STJW 18.3 AWG cable whip included
- Dark Sky Compliant (3000K setting @ no tilt)
- House side shields available
- Select-n-Switch Technology
- Instant-On to full brightness
- Twist-C Control: Control ready receptacle built into each fixture
 - Standard Sensors
 - SILVAIR Bluetooth Mesh
 - ENVISIONLS Bluetooth
 - [Click Here](#) for More Information

Driver Options:

- UNV: 120-277V
- HV: 277-480V 0-10V Dimmable
- Built in 6kV Surge Protector
 - 20kV available
- THD: <15% (+/-5% tolerance), PF >0.9, 50/60Hz

Mounting & Installation:

- Optional tenon mount adaptors available
- Several standard bracket options available (see page 4)

Certifications:

- UL Listed for USA and CA
- DLC Premium Listed
 - View DLC ID Chart
- ROHS Compliant
- Approved for CA T24
- 7 Year Limited Warranty
- FCC CFR 47, GCC Part 15, Subpart B:2017

WATT	LUMENS	WATT	LUMENS
20	2,800	200	28,000
40	5,600	215	30,100
60	8,400	225	31,500
70	10,150	240	33,600
90	12,600	250	35,000
100	14,000	275	38,500
110	15,400	300	42,000
130	18,200	330	46,200
140	19,600	360	50,400
150	21,000	390	54,600
165	23,100	420	58,800
190	26,600	450	63,000

LUMENS BASED OFF 4000K. 30K & 50K +/- 5%

DLC Premium Product ID		
	Architectural Flood and Spot Luminaires	Outdoor Pole/Arm-Mounted Area and Roadway Luminaires
LED-ARL3-5P100-TRI-BZ-UNV	S-965NIT	S-6D7IO5
LED-ARL3-5P150-TRI-BZ-UNV	S-PDO3Y1	S-MKROP7
LED-ARL3-5P150-TRI-BZ-HV	S-KMCBQL	S-EP01F6
LED-ARL3-5P240-TRI-BZ-UNV	S-NQ3WB6	S-D9HN81
LED-ARL3-5P300-TRI-BZ-UNV	S-W5J6YS	S-H859CZ
LED-ARL3-5P300-TRI-BZ-HV	S-JNQMZC	S-D9KMF0
LED-ARL3-5P450-TRI-BZ-UNV	S-NV2MP3	S-BNJ271
LED-ARL3-5P450-TRI-BZ-HV	S-XZ5QR2	S-IZY8SO

Series	Power	3CCT	Finish ¹	Voltage ²	Photocell	EMB
LED-ARL3 -	5P100	- TRI - 30/40 50K	BZ Bronze (Standard) BL ¹ Black WH ¹ White GRY ¹ Gray CS ¹ Custom Color	UNV	(Blank)	(Blank)
	100/80/60/40/20W			120-277V (6kV Surge Protector)	No Photocell	No Emergency
	5P150			HV	PC	EMB
	150/130/110/90/70W			277-480V (6kV Surge Protector)	Photocell	40W Remote emergency
	5P240			UNV20KV		6,000lm
	240/215/190/165/140W			120-277V (20kV Surge Protector)		
	5P300			HV20KV		
300/275/250/225/200W	277-480V (6kV Surge Protector)					
5P450						
450/420/390/360/330W						

1. Standard quickship finish is bronze. Other colors are custom finishes.
 2. 5P100, 5P240 are not available in HV
 a. 6kV quick ship. 20kV models are made to order.

Required Accessories	
Bronze Bracket Finish	
ARL3-SF	(Blank)
Slip Fitter	Bronze
ARL3-SA	BL ¹
Straight Arm	Black
Adjustable	WH ¹
ARL3-SFA	White
Slip Fitter/Straight	GRY ¹
Arm Combo	Gray
ARL3-TR	CS ¹
Trunnion	Custom
ARL3-YK	
-100-150	
Yoke for 100-150	
ARL3-YK	
-240-450	
Yoke for 240-450	

1. Standard quickship finish is bronze. Other colors are custom finishes.

Optional Accessories (Order Separately)			
Control Sensor	Wall Mount Must purchase with SA or SFA	Shields Use as House or Front Side	Field Install Optic Options
S-TWC-MW-1			
S-Line:Twist-C			
Microwave Sensor	ARL3-WM	ARL3-100-150W-HSS-BZ	(Blank)
S-TWC-PIR-1	ARL3-WM-BL	5P100 & 5P150	Type 3 (Included)
S-Line: Twist-C	ARL3-WM-WH	ARL3-240-300W-HSS-BZ	ARL3-T-II-100-150
PIR Sensor		5P240 & 5P300	Type II
S-TWC-PIR-SL		ARL3-450W-HSS-BZ	ARL3-T-IV-100-150
PIR SILVAIR		5P450	Type IV
Bluetooth Mesh			ARL3-T-V-100-150
S-TWC-PIR-BT			Type V
PIR ENVISIONLS			ARL3-T-II-240-300
Bluetooth Control			Type II
TWC-DL			ARL3-T-IV-240-300
S-Line: Twist-C			Type IV
Daylight Sensor:			ARL3-T-V-240-300
Photocell			Type V
			ARL3-T-II-450
			Type II
			ARL3-T-IV-450
			Type IV
			ARL3-T-V-450
			Type V

Large Area Light: Bolt-Line

3-CCT & 5-Power Selectable

FEATURES

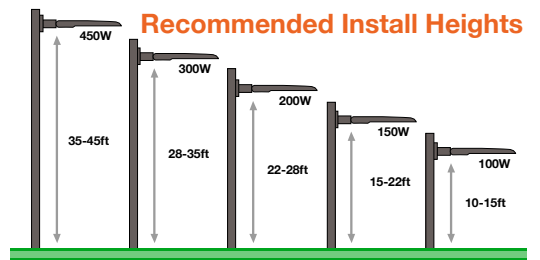

Die-Cast Aluminum

Wattage Selector Inside J-Box

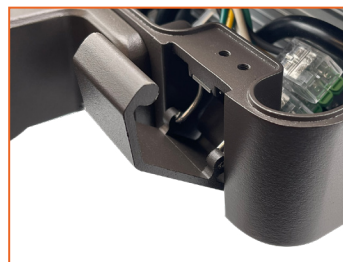
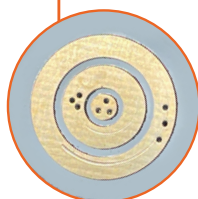
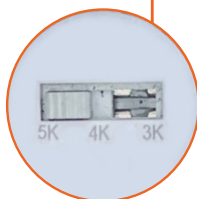

Optic Lens

EPA & BUG										
WATTAGE	1PC FIXTURE		2PC 180°		2PC 90°		3PC 90°		4PC 90°	
	BUG									
5P100 & 5P150	B3-U0-G3	0.384	0.776	0.599	0.914	0.914				
5P240 & 5P300	B4-U0-G4	0.468	0.945	0.73	1.114	1.114				
5P450	B5-U0-G5	0.61	1.232	0.949	1.453	1.453				

BRACKET DIMENSIONS

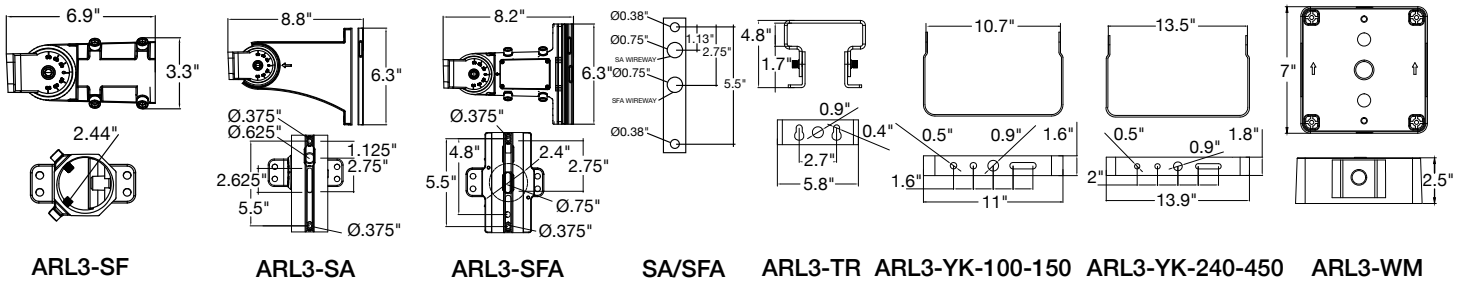

100W/150W

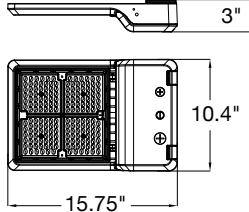

240W/300W

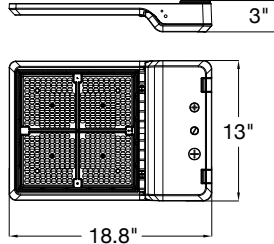

450W

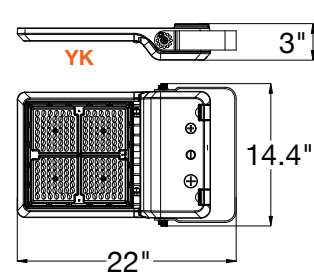
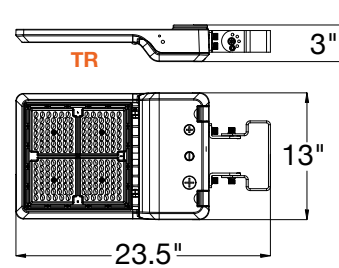
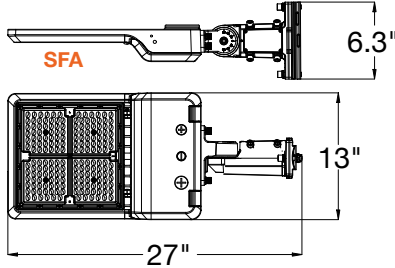
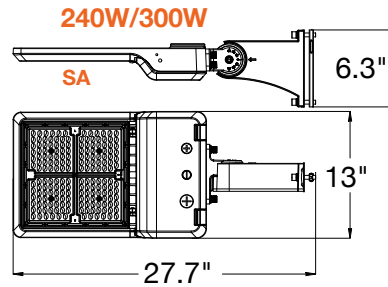
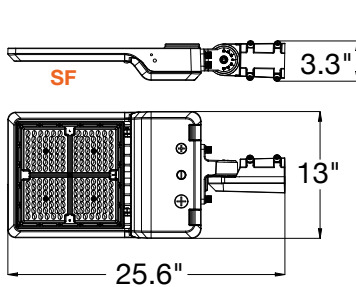
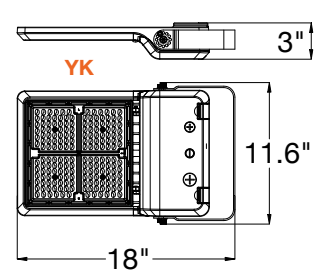
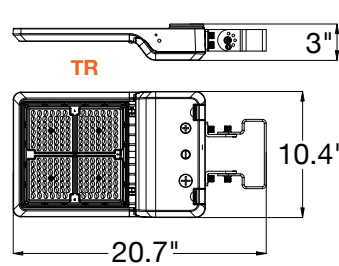
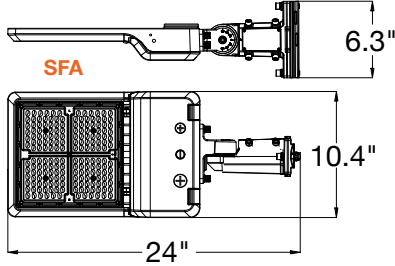
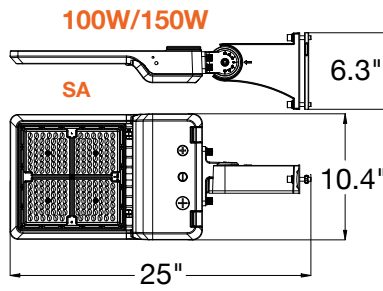
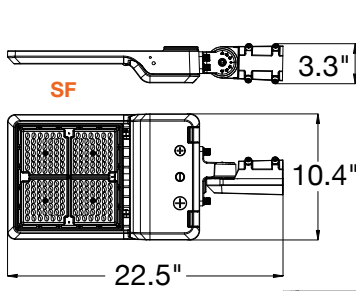
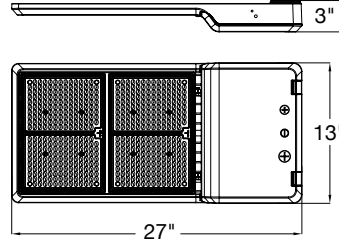

450W

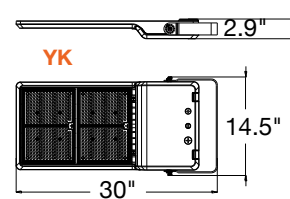
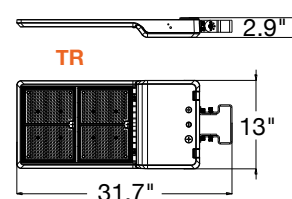
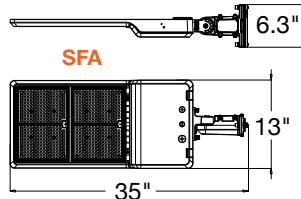
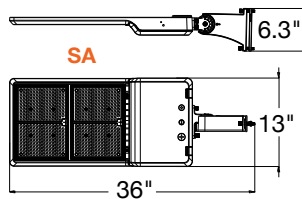
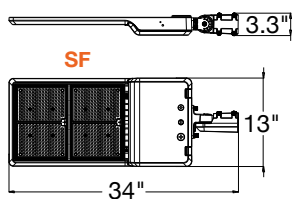

ACCESSORIES



ARL3-YK-100-150
ARL3-YK-240-450

Yoke

- Flood light bracket
- Ideal use on a wall
- Adjustable design to angle area light luminaire

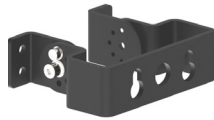

ARL3-TR

Trunnion

- Flood light bracket
- Ideal use on a wall
- Can be used for shoebox
- Adjustable design to angle area light luminaire



ARL3-SA

Straight Arm Adjustable

- For use with round or square poles
- Adjustable design to angle area light luminaire



ARL3-SF

Slip Fitter

- For use with round or square poles
- Adjustable design to angle area light luminaire
- Fits 2 3/8" tenon



ARL3-SFA

Slip Fitter & Straight Arm

- Flood light bracket
- For use with round or square poles
- Can be used for shoebox
- Adjustable design to angle area light luminaire



ARL3-WM

Wall Mount Adapter

- Attach to SA or SFA arm
- Does not attach to the body of the fixture directly

Accessory Model	Description
ARL3-T-II-100-150	ARL3: Type II Optics Lens
ARL3-T-IV-100-150	ARL3: Type IV Optics Lens
ARL3-T-V-100-150	ARL3: Type V Optics Lens
ARL3-T-II-240-300	ARL3: Type II Optics Lens
ARL3-T-IV-240-300	ARL3: Type IV Optics Lens
ARL3-T-V-240-300	ARL3: Type V Optics Lens
ARL3-T-II-450	ARL3: Type II Optics Lens
ARL3-T-IV-450	ARL3: Type IV Optics Lens
ARL3-T-V-450	ARL3: Type V Optics Lens

Accessory Model	Description
ARL3-SF	ARL3: Slip Fitter
ARL3-SA	ARL3: Straight Arm
ARL3-SFA	ARL3: Slip Fitter/Straight Arm Combo
ARL3-TR	ARL3: Trunnion
ARL3-YK-100-150	ARL3: Yoke
ARL3-WM	ARL3: Wall Mount Adapter
ARL3-YK-240-450	ARL3: Yoke
ARL3-100-150W-HSS-BZ	ARL3: Front & House Side Shield for 100W and 150W
ARL3-240-300W-HSS-BZ	ARL3: Front & House Side Shield for 240W and 300W
ARL3-450W-HSS-BZ	ARL3: Front & House Side Shield for 450W
PC-TWL-HV	LC4535INT 3PIN Locking Type Thermal Photo Control 480V Intermatic
PC-TWL-UNV	JL207C 3PIN Locking Type Thermal Photo Control 120-277V Intermatic
PC-SHORT-CAP	3 Pin Shorting Cap
S-TWC-MW-BT	S-Line: Twist-C Microwave Sensor w/ Bluetooth
TWC-DL	S-Line: Twist-C Daylight Sensor: Dusk to Dawn, works like a photocell
S-LINE-R	Remote for S-LINE Series Sensors

Accessory	Description
ARL3-WM	ARL3: Wall Mount Bracket (Requires ARL3-SA for mounting) Bronze
ARL3-WM-BL	ARL3: Wall Mount Bracket (Requires ARL3-SA for mounting) Black
ARL3-WM-WH	ARL3: Wall Mount Bracket (Requires ARL3-SA for mounting) White

Accessory	Description
S-TWC-MW-1	S-Line: Twist-C Microwave Sensor Remote Required: (S-LINE-R)
S-TWC-PIR-1	PIR Bi-Level Motion + Daylight Sensor (Remote Req'd)
S-TWC-PIR-SL	PIR SILVAIR Bluetooth Mesh
S-TWC-PIR-BT	PIR ENVISIONLS Bluetooth Control
S-TWC-DL	S-Line: Twist-C Daylight Sensor: Photocell

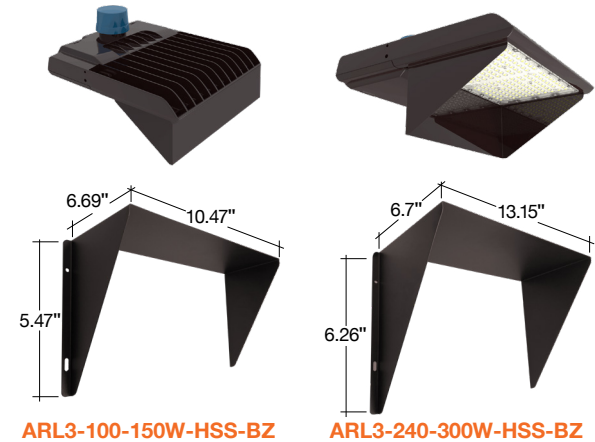

S-TWC-PIR-1
S-TWC-PIR-SL
S-TWC-PIR-BT



S-TWC-MW-1
S-TWC-MW-BT
S-TWC-DL



S-LINE-R
Controller



Optic Lenses

Beam Angle: Type III Installed (Type II, IV, V included in box)
Tool-free interchangeable in the field



3 Pin Photocell
120-277V
PC-TWL-UNV











3 Pin Photocell
347-480V
PC-TWL-HV



PC
Short Cap
PC-SHORT-CAP

Control Options

EnVision LED offers 3 control systems compatible with our LED Fixtures for projects of all sizes and budgets.

	Basic Controls	EnVisionLS 	EnVisionLED.x SILVAIR 
Description	Standard Plug In Sensors	Basic Bluetooth Wireless Control	Advanced Bluetooth Wireless Control
Recommended Quantity (but not limited to)	N/A	>40-50 Nodes	>50 Nodes
Maximum Zone Quantity	N/A	100	3,000
Commissioning Tool	Remote Only	  ENVISIONLS App 	  SILVAIR App 
Commissioning Process	Individually Set via Remote	Wireless Must be done on site	Wireless- Initial linking must be done on site. Commissioning can be done via desktop remotely.
Floor Plan Upload	N/A	N/A	Yes Add a floor plan and mark luminaires & zones via desktop
Gateway	N/A	N/A	Required only for energy monitoring, advanced scheduling, automated demand response.
Individual Luminaire Control	Yes	Yes	Yes
Luminaire Grouping Zoning	N/A	Yes	Yes
High End Power Low End Power	Yes but limited (View Remote)	Yes	Yes
Cost	\$	\$\$	\$\$\$
DLC NLC Listed	N/A	Yes	Yes
Energy Monitoring & Data Reporting	N/A	N/A	Monitor energy usage per individual zone & retrofit cost savings calculation + detailed reporting







Compatible Products:

EnVision offers a variety of nodes, sensors, & gateways that are controlled via remote, ENVISIONLS Bluetooth Mesh & SILVAIR Bluetooth Mesh on all of our 0-10V dimmable fixtures.





Individual Fixture Controls: PIR Sensor, Bi-Level Dimming, Daylight

Basic Note: **-1** • ENVISIONLS Models Note: **-BT** • SILVAIR Models Note: **-SL**

	MODEL #	DESIGN	RECOMMENDED FIXTURE	FEATURES
	S-TWC-PIR-1 S-TWC-PIR-BT S-TWC-PIR-SL	Twist-C Control Sensor	Sensor Ready Fixtures: Area Lights, Canopies, Flood Lights, High Bays	All models are equipped with PIR occupancy sensing, high & low end bi-level dimming, & daylight sensing.
	S-TWC-90 + S-TWC-PIR-1 S-TWC-90 + S-TWC-PIR-BT S-TWC-90 + S-TWC-PIR-SL	Twist-C Control Sensor + 90 Degree Arm	Cylinders, Strips, Wall Packs	
	S-AUD-PIR-1 S-AUD-PIR-BT S-AUD-PIR-SL	2.5m Audio Jack	Panels & Troffers	
	S-SN-PIR-1 S-SN-PIR-BT S-SN-PIR-SL	Snap In Sensor	Troffers & Wraps	

Group Controls ENVISIONLS Models Note : **-BT** • SILVAIR Models Note: **-SL**

	MODEL #	DESIGN	VOLTAGE	FEATURES	RECOMMENDED FEATURES
	S-CM-PIR-LV-BT S-CM-PIR-LV-SL	Ceiling Mounted PIR Sensor	12-24V	PIR Sensor, Bi-Level Dimming, Daylight, 360° detection, 12' Max Mounting Height	Connects to 0-10V dimmable fixtures
	S-WM-PIR-CUNV-BT S-WM-PIR-CUNV-SL	Wall Mounted PIR Occupancy Sensor, Bi-Level Dimming, Daylight	120-277V	On/Off PIR occupancy sensor, 180° detection, 30' detection @ 4' Mounting Height	Connects to LED fixtures
	S-WS-120V-USB-SL		120V	Dimming Wall Socket, Two Sockets	Floor Lamps, Other Lamps

Gateway (Silvair Only) 4.5–5.5 V DC, 2A Power over Ethernet 36–57 V DC

	MODEL #	DESIGN	VOLTAGE	FEATURES	RECOMMENDED FEATURES
	SGW-102	Wall or Ceiling Mounted	POE	Advanced Energy Monitoring Control	Connects to Silvair Controls. Gateway is not required.