



ARCY-Line: CADM Commercial Downlights

2-Piece Design + Adjustable Beam Angle



Detail Specification:

- Finish: White Smooth & Clear-Specular Options
- Round or Square Trims Available
- Wet Location Rated
- Field Adjustable Beam Angle: 24-45°
- Chip: COB, R9 >50, CRI >90, UGR<16
- 3 Step MacAdam Ellipses
- Operating Temperature: -40° - 114° F
- Lens: Frosted PC, non-yellowing
- Average life (L70) of 70,000 hours

Applications:

- General Recessed Lighting
- Residential & Multifamily
- Office, Hallways and Meeting Rooms
- Education, Healthcare, Retail, Hospitality
- Commercial Lighting

Product Information:

- Metal housing and trim for better heat dissipation
- Module twists and locks into the trim
- SnapTrim Canless: Spring clips with remote j-box eliminates can
- Deep reflector lens reduces glare and optimizes even beam distribution
- 3M20, 3M30, 3M35: Compatible with 4", 6", 8", 10" Trims
- 3M55: Compatible with 6", 8", 10" Trims
- Select-n-Switch Technology: 5-CCT + 3-Power Selectable

Driver Options:

- 120-277V 0-10V Dimmable down to 1%
- THD: <20% (+/-5% tolerance), PF >0.9, 50/60Hz
- Built in 2.5Kv Surge Protector
- Flicker Free

Mounting & Installation:

- Cut Out Dimensions:
 - 4": 4-3/4" -- 5-1/2"
 - 6": 6-1/8" -- 7-3/16"
 - 8": 7-1/2" -- 8-7/8"
 - 10": 9" -- 10"
- Optional new construction plate available
- This fixture does not fit into a recessed can
- No housing needed in remodel applications, tension clips mount into 1/2" to 1.5" thick ceiling
- Can be removed from below the ceiling for service or replacement
- Pre-wired junction box with circuit wiring built in (3 in / 3 out)

Certifications:

- ETL Listed for USA and CA
- Energy Star Certified
- CA Title 24 JA8-2022 CEC Listed
- 5 Year Limited Warranty
- FCC CFR 47, GCC Part 15, Subpart B:2017
- 3M20 Module is IC Rated and ASTM-E283 Air-Tight
- 3M30, 3M35, 3M55 is Non-IC



Black Trim Reflector



Square Reflector

PICK YOUR MODEL (REQ'D)

Modules	Voltage ¹	Emergency
LED-CADM-3M20-5CCT 10/12/20W • 750/1,000/1,500lm	UNV 120-1277V	(Blank) No Emergency
LED-CADM-3M30-5CCT 20/24/30W • 1,700/2,000/2,400lm	HV 347-480V	Backup
LED-CADM-3M55-30K 32/40/55W • 3,200/4,000/5,000lm		EMB Emergency
LED-CADM-3M55-35K 32/40/55W • 3,200/4,000/5,000lm		Backup
LED-CADM-3M55-40K 32/40/55W • 3,200/4,000/5,000lm		

1. HV: Step down transformer into 4" j-box

PICK YOUR TRIM (REQ'D)

Trim ²	Optional Accessories (Order Separately)		
	Goof Ring	New Construction Plates	Emergency Backup ³ Junction Box
CADM-4-CSH² 4" Round Clear-Specular Haze Reflector / White Flange	GR-4-WH 4-8" Width	C4-NC-RI-JJBX 4" plate w/ handling bars + j-box (Round Models)	LED-EMB-8W-HV-0/10V-2P 8W Emergency Backup
CADM-4-WH² 4" Round White Reflector White Flange	GR-6-WH 6-3-10" Width	C6-NC-RI-JJBX 6" plate w/ handling bars + j-box (Round Models)	JBOX-ALM Junction box with 4 1/2" knockouts
CADM-4-CSH-SQ² 4" Square Clear-Specular Haze Reflector / White Flange	GR-8-WH 8-12.5" Width	C8/10-NC-RI-JJBX 8 & 10" plate w/ handling bars + j-box (Round Models)	LED-EMB-15W-HV-0/10V-2P 15W Emergency Backup
CADM-4-CSH-BLK² 4" Round Clear-Specular Haze Reflector / Black Flange	GR-10-WH 9-14.1" Width	CUNV-NC-RI-JJBX 4, 6, 8, 10" plate w/ handling bars + j-box (Round Models)	LED-EMB-25W-HV-0/10V-2P 25W Emergency Backup
CADM-6-CSH 6" Round Clear-Specular Haze Reflector / White Flange		CUNV-NC-SQ-RI-JJBX 4, 6, 8" plate w/ handling bars + j-box (Square Models)	
CADM-6-WH 6" Round White Reflector White Flange		CUNV-NC-ICAT-7H 4, 6, 8" Universal plate w/ hanging bars (Round Models)	
CADM-6-CSH-SQ 6" Square Clear-Specular Haze Reflector / White Flange		CUNV-NC-ICAT-6SQ 4, 6, 8" Universal plate w/ hanging bars (Square Models)	
CADM-6-CSH-BLK 6" Round Clear-Specular Haze Reflector / Black Flange		CUNV-JBX-RI-XL 4, 6, 8" Universal tough in plate. Extra long.	
CADM-8-CSH 8" Round Clear-Specular Haze Reflector / White Flange			
CADM-8-WH 8" Round White Reflector White Flange			
CADM-8-CSH-SQ 8" Square Clear-Specular Haze Reflector / White Flange			
CADM-8-CSH-BLK 8" Round Clear-Specular Haze Reflector / Black Flange			
CADM-10-CSH 10" Round Clear-Specular Haze Reflector / White Flange			
CADM-10-WH 10" Round White Reflector / White Flange			

2. Only compatible with 3M20 & 3M30
 3. Field installable. Lasts 90 minutes.

Specs and model numbers are subject to change with or without notice.

ARCY-Line: CADM Commercial Downlights

2-Piece Design + Adjustable Beam Angle

FEATURES



DIMENSIONS

DOWNLIGHT MODULE

3M55

Compatible with 6", 8", 10"

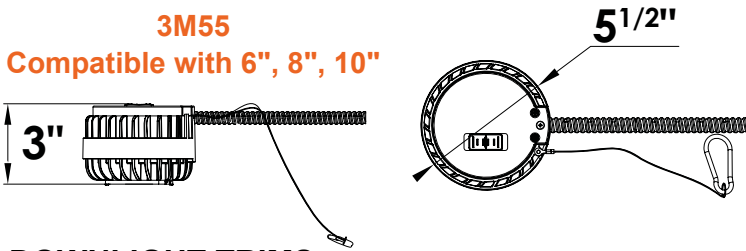

3M20, 3M30 & 3M35
Compatible with 4", 6", 8", 10"

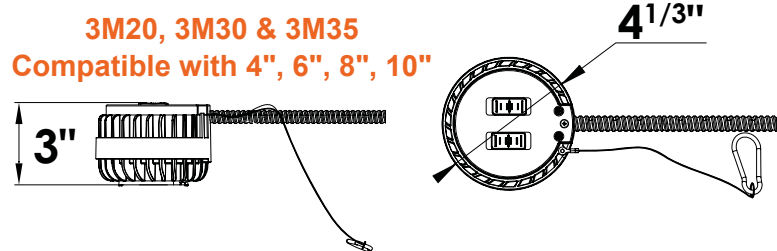

DOWNLIGHT TRIMS

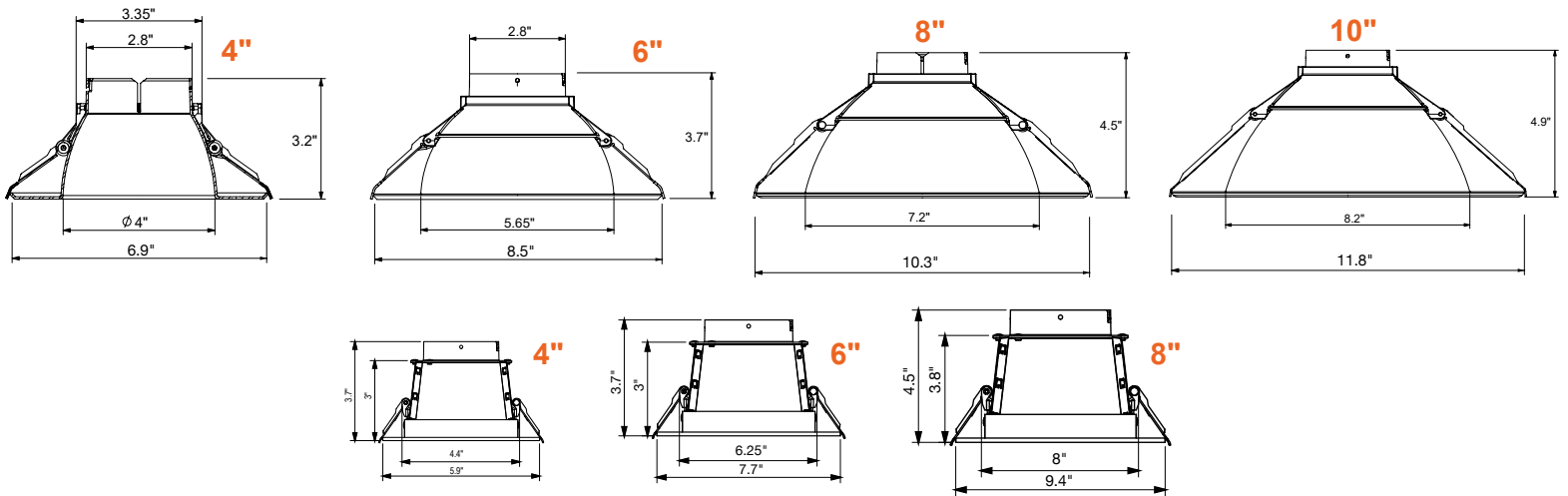

ACCESSORIES

TRIMS



CSH



WH



BLK



SQ

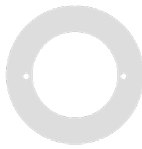

GR-4-WH
GR-6-WH
GR-8-WH
GR-10-WH

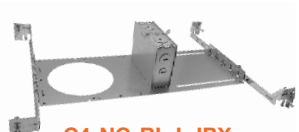

C4-NC-RI-J-JBX
17" W x 6.5" D x 3.5" H
5" Hole
14" Min. Extend
25" Max. Extend
(Assembly Required)



C6-NC-RI-J-JBX
18.5" W x 9" D x 4" H
6.25" Hole
14.25" Min. Extend
25" Max. Extend
(Assembly Required)



C8/10-NC-RI-J-JBX
18.5" W x 12" D x 4" H
8" Hole
14" Min. Extend
25" Max. Extend
(Assembly Required)



CUNV-NC-RI-J-JBX
21.2" W x 12" D x 1.6" H
(Assembly Required)

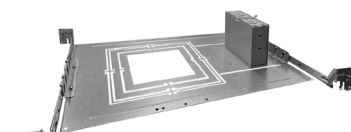

CUNV-NC-SQ-RI-J-JBX
21.2" W x 12" D x 1.6" H
(Assembly Required)

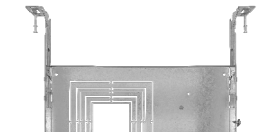

CUNV-NC-ICAT-6SQ
Universal Pre-Mounting Plate
13.75" x 14"



CUNV-NC-ICAT-7H
Universal Pre-Mounting Plate
13 7/8" x 15 1/8"



LED-EMB-8W-HV-0/10V-2P
LED-EMB-15W-HV-0/10V-2P
LED-EMB-25W-HV-0/10V-2P



CUNV-JBX-RI-XL
7" x 26"

DOWNLIGHT MODULE

Model	Voltage	Watts	Lumens	Color	CRI
LED-CADM-3M20-5CCT-UNV	120-277V	10/12/20w	750/1000/1500lm	27/30/35/40/50K	>90
LED-CADM-3M30-5CCT-UNV	120-277V	13/20/35w	1700/2000/2400lm	27/30/35/40/50K	>90
LED-CADM-3M55-30K-UNV	120-277V	32/40/55w	3200/4000/5000lm	3000k	>90
LED-CADM-3M55-35K-UNV	120-277V	32/40/55w	3200/4000/5000lm	3500k	>90
LED-CADM-3M55-40K-UNV	120-277V	32/40/55w	3200/4000/5000lm	4000k	>90

TRIMS

Model	Description
CADM-4-CSH	4" Round Clear-Specular Haze Reflector / White Flange
CADM-4-WH	4" Round White Reflector / White Flange
CADM-4-CSH-BLK	4" Round Clear-Specular Haze Reflector / Black Flange
CADM-4-CSH-SQ	4" Square Clear-Specular Haze Reflector / White Flange
CADM-6-CSH	6" Round Clear-Specular Haze Reflector / White Flange
CADM-6-WH	6" Round White Reflector / White Flange
CADM-6-CSH-BLK	6" Round Clear-Specular Haze Reflector / Black Flange
CADM-6-CSH-SQ	6" Square Clear-Specular Haze Reflector / White Flange
CADM-8-CSH	8" Round Clear-Specular Haze Reflector / White Flange
CADM-8-WH	8" Round White Reflector / White Flange
CADM-8-CSH-BLK	8" Round Clear-Specular Haze Reflector / Black Flange
CADM-8-CSH-SQ	8" Square Clear-Specular Haze Reflector / White Flange
CADM-10-CSH	10" Round Clear-Specular Haze Reflector / White Flange
CADM-10-WH	10" Round White Reflector / White Flange

GOOF RING

Accessory Model	Description
GR-4-WH	4" Goof Ring, Inner Dim: 4.9" Outer Dim: 6.5"
GR-6-WH	6" Goof Ring, Inner Dim: 6.3" Outer Dim: 10.5"
GR-8-WH	8" Goof Ring, Inner Dim: 8" Outer Dim: 12.5"
GR-10-WH	10" Goof Ring, Inner Dim: 9" Outer Dim: 14.1"

NEW CONSTRUCTION PLATES

Accessory Model	Description
C4-NC-RI-J-JBX	4" plate w/ hanging bars + j-box (Round Models)
C6-NC-RI-J-JBX	6" plate w/ hanging bars + j-box (Round Models)
C8/10-NC-RI-J-JBX	8 & 10" plate w/ hanging bars + j-box (Round Models)
CUNV-NC-RI-J-JBX	4, 6, 8, 10" plate w/ hanging bars + j-box (Round Models)
CUNV-NC-SQ-RI-J-JBX	4, 6, 8" plate w/ hanging bars + j-box (Square Models)
CUNV-NC-ICAT-7H	4, 6, 8" Universal plate w/ hanging bars (Round Models)
CUNV-NC-ICAT-6SQ	4, 6, 8" Universal plate w/ hanging bars (Square Models)
CUNV-JBX-RI-XL	4, 6, 8" Universal tough in plate. Extra long.

BATTERY BACK-UP

Accessory	Description
LED-EMB-8W-HV-0/10V-2P	8W Emergency Backup
LED-EMB-15W-HV-0/10V-2P	15W Emergency Backup
LED-EMB-25W-HV-0/10V-2P	25W Emergency Backup

JUNCTION BOX

Accessory	Description
JBOX-ALM	Junction box with 4 1/2" knockouts

TESTED COMPATIBLE DIMMERS

Other dimmers may be compatible but have not been tested. Please contact us for more information.

Brand	Item#	Brand	Item#
Synergy	ISD BC 120/277 WH	Leviton	IP710-DLZ
Eaton	SF10P-W	Lithonia Lighting	ISD BC 120/277 WH
Lutron	DVSTV-WH		



J-BOX ALM
4.46" W x 3.04" D x 1.37" H