

4" Regressed Downlight

5-CCT Selectable

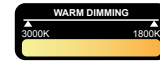

Detail Specifications:

- Finish: White, Black, Custom
- Wet Location Rated
- Beam Angle: 38° standard, other options available
- Chip: COB Chip, R9 >50, CRI >90
- 2 Step MacAdam Ellipses
- Operating Temperature: -40° - 114° F
- Lens: Frosted, non-yellowing
- Average life (L70) of 50,000 hours

Applications:

- General Recessed Lighting
- Residential & Multifamily
- Office and Meeting Rooms
- Education, Healthcare, Retail, Hospitality

Product Information:

- 5-CCT Selectable: 27/30/35/40/50K
- Various sizes, finishes, and trims available
- Standard white round trim included: optional trims available
- Metal housing and trim for better heat dissipation
- Optional emergency backup available: delivers full lumens in EM mode up to 25W
- SnapTrim Canless: Spring clips with remote j-box eliminates can

Driver Options:

- 120V Triac Dimmable
- 0/10V: 120-277V 0-10V Dimmable
- Built in 2.5Kv Surge Protector
- Flicker Free

Mounting & Installation:

- Cut Out Dimension: 3-3/4"
- Optional new construction plate available
- This fixture does not fit into a recessed can
- No housing needed in remodel applications, tension clips mount into 1/2" to 1.5" thick ceiling
- Can be removed from below the ceiling for service or replacement
- Pre-wired junction box with circuit wiring built in (3 in/ 3 out)

Certifications:

- ETL Listed for USA and CA
- Energy Star Certified
- CA Title 24 JA8-2022 CEC Listed
- 5 Year Limited Warranty
- FCC CFR 47, GCC Part 15, Subpart B:2017
- IC Rated and ASTM-E283 Air-Tight
- Complies with UL 263, ASTM E119, CAN ULC S101

Certifications:

- 5CCT: 27/30/35/40/50k
- 3WD: 30-18K Warm Dimming

| Series | Emergency | Beam Angle |
|-----------------------------------|--------------|------------|
| LED-DLJBX-4RG-15W-5CCT-WH-R | (Blank) | (Blank) |
| 15W • 1,100lm • 120V | No Emergency | 38° |
| LED-DLJBX-4RG-15W-5CCT-WH-R-0/10V | Backup | 60D |
| 15W • 1,100lm • 120-277V | EMB | 60° |
| LED-DLJBX-4RG-18W-5CCT-WH-R | Emergency | |
| 18W • 1,500lm • 120V | Backup | |
| LED-DLJBX-4RG-12W-3WD-WH-R | | |
| 12W • 850lm • 120V | | |

Optional Accessories (Order Separately)

| Round Trim | Square Trim | New Construction Plates | Extension Cables | Emergency Backup (field install) 1 | Goof Ring |
|--------------------------------------|--|---|-----------------------------------|------------------------------------|------------------|
| DLJBX-4RG-TRIM-BLK-R Black Round | DLJBX-4RG-TRIM-WH-SQ White Square | CUNV-NC-ICAT-7H Universal Plate with Hanging Bars | JBX-EXT-6'-2PIN 6' Extension | LED-EMB-25W-HV -0/10V-2P | GR-4-WH 4"-8" |
| DLJBX-4RG-TRIM-BRZ-R Bronze Round | DLJBX-4RG-TRIM-BLK-SQ Black Squared | C4-JBX-RI 4" Rough in plate | JBX-EXT-10'-2PIN 10' Extension | Up to 24W fixtures | Width |
| | DLJBX-4RG-TRIM-BRZ-SQ Bronze Square | CUNV-JBX-RI-XL Universal Rough In Plate Extra Long | JBX-EXT-12'-2PIN 12' Extension | | |

1. Field installable. Lasts 90 minutes.

4" Regressed Downlight

5-CCT Selectable

FEATURES

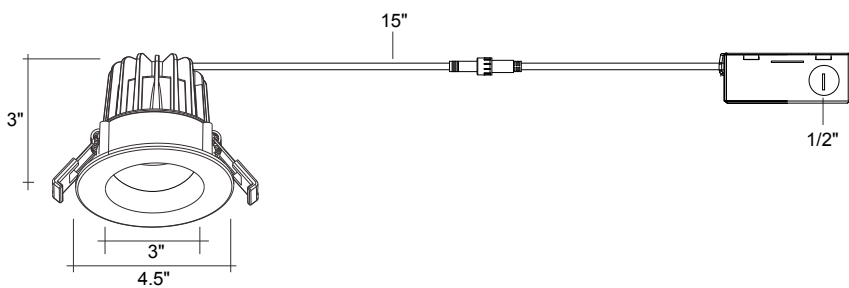
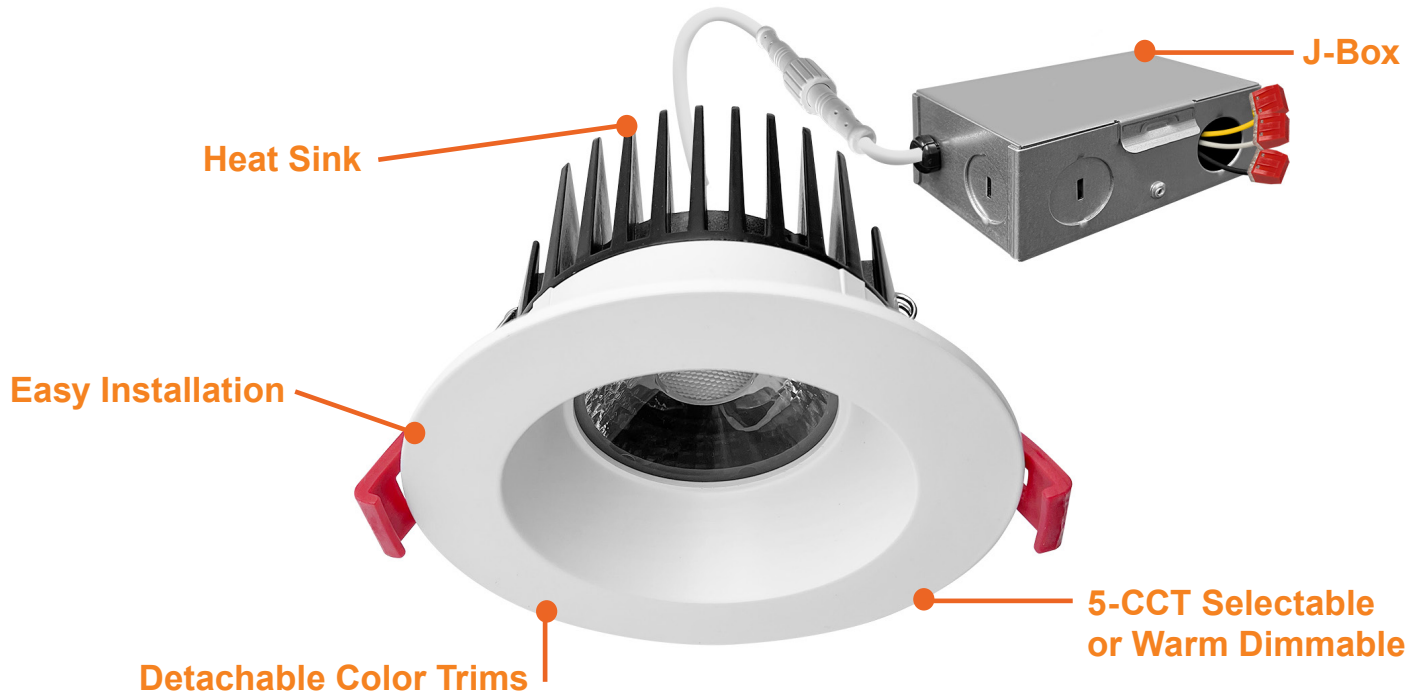

15W

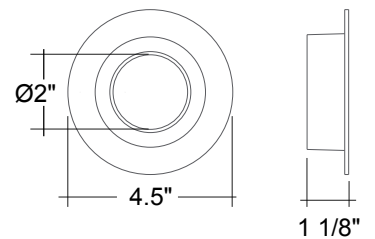

4" Round Trim

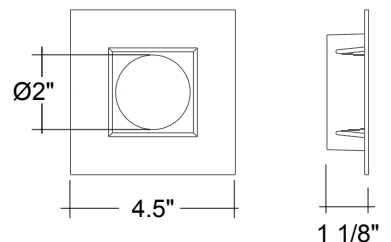
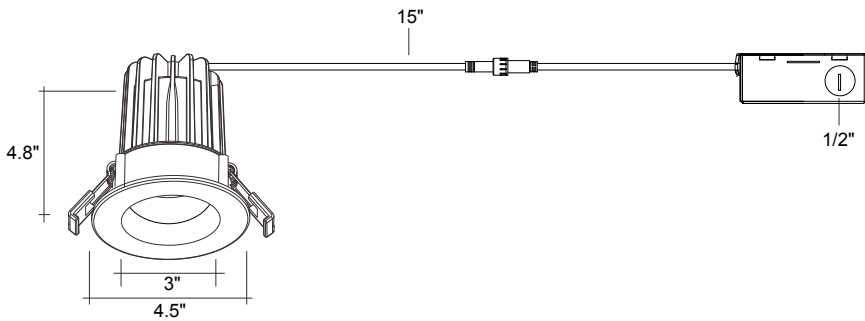

4" Square Trim

4" Regressed Downlight

5-CCT Selectable

ACCESSORIES



White (-WH)
Included



White (-WH-SQ)



Bronze (-BRZ-R)



Bronze (-BRZ-SQ)



Black (-BLK-R)



Black (-BLK-SQ)

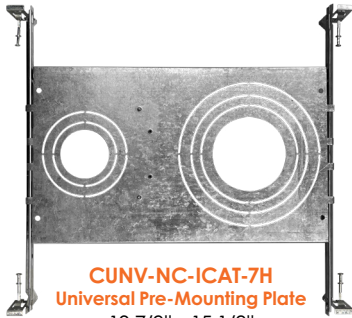

CUNV-NC-ICAT-7H
Universal Pre-Mounting Plate
13 7/8" x 15 1/8"

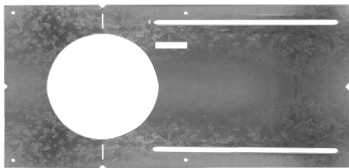

C4-JBX-RI
4" Rough In Plate
6 1/2" x 17 1/4"

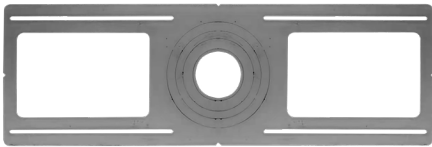

CUNV-JBX-RI-XL
7" x 26"



JBX-EXT
6' / 10' / 12' Extension Cable

TRIMS

| Accessory | Description |
|------------------------|--|
| Add '-EMB-' to model # | Emergency Backup (External 25W) |
| DLJBX-4RG-TRIM-WH-SQ | 4" Regressed Gimbal White Square Trim |
| DLJBX-4RG-TRIM-BLK-R | 4" Regressed Gimbal Black Round Trim |
| DLJBX-4RG-TRIM-BLK-SQ | 4" Regressed Gimbal Black Square Trim |
| DLJBX-4RG-TRIM-BRZ-R | 4" Regressed Gimbal Bronze Round Trim |
| DLJBX-4RG-TRIM-BRZ-SQ | 4" Regressed Gimbal Bronze Square Trim |

CONSTRUCTION PLATES

| Accessory | Description |
|-----------------|--|
| CUNV-NC-ICAT-7H | 1" 2" 3" 3.5" 4" 5" 6" Universal Pre-Mounting New Construction Plate |
| C4-JBX-RI | 4" Rough In Plate |
| CUNV-JBX-RI-XL | Universal tough in plate (Extra Long) |

EXTENSION CABLE

| Accessory | Description |
|------------------|---------------------|
| JBX-EXT-6'-2PIN | 6" Extension Cable |
| JBX-EXT-10'-2PIN | 10" Extension Cable |
| JBX-EXT-12'-2PIN | 12" Extension Cable |

BATTERY BACK-UP

| Accessory | Description |
|-------------------------|--------------------|
| LED-EMB-25W-HV-0/10V-2P | Up to 24W fixtures |

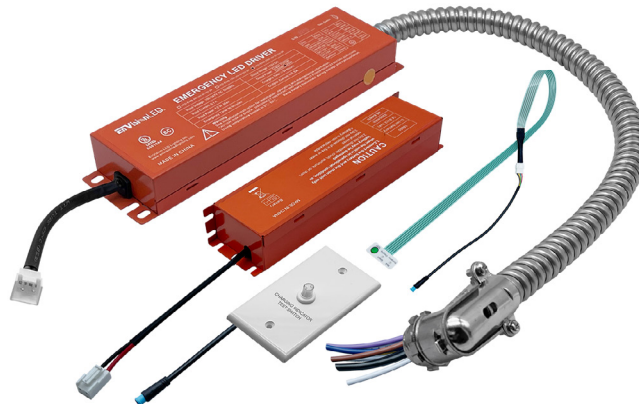

LED-EMB-25W-HV-0/10V-2P

