

4" Regressed Downlight

5-CCT Selectable

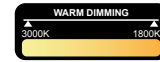

Detail Specifications:

- Finish: White, Black, Custom
- Wet Location Rated
- Beam Angle: 38° standard, other options available
- Chip: COB Chip, R9 >50, CRI >90
- 2 Step MacAdam Ellipses
- Operating Temperature: -40° - 114° F
- Lens: Frosted, non-yellowing
- Average life (L70) of 50,000 hours

Applications:

- General Recessed Lighting
- Residential & Multifamily
- Office and Meeting Rooms
- Education, Healthcare, Retail, Hospitality

Product Information:

- 5-CCT Selectable: 27/30/35/40/50K
- Various sizes, finishes, and trims available
- Standard white round trim included: optional trims available
- Metal housing and trim for better heat dissipation
- Optional emergency backup available: delivers full lumens in EM mode up to 25W
- SnapTrim Canless: Spring clips with remote j-box eliminates can

Driver Options:

- 120V Triac Dimmable
- 0/10V: 120-277V 0-10V Dimmable
- Built in 2.5Kv Surge Protector
- Flicker Free

Mounting & Installation:

- Cut Out Dimension: 3-3/4"
- Optional new construction plate available
- This fixture does not fit into a recessed can
- No housing needed in remodel applications, tension clips mount into 1/2" to 1.5" thick ceiling
- Can be removed from below the ceiling for service or replacement
- Pre-wired junction box with circuit wiring built in (3 in/ 3 out)

Certifications:

- ETL Listed for USA and CA
- Energy Star Certified
- CA Title 24 JA8-2022 CEC Listed
- 5 Year Limited Warranty
- FCC CFR 47, GCC Part 15, Subpart B:2017
- IC Rated and ASTM-E283 Air-Tight
- Complies with UL 263, ASTM E119, CAN ULC S101

Certifications:

- 5CCT: 27/30/35/40/50k
- 3WD: 30-18K Warm Dimming

Series	Emergency	Beam Angle
LED-DLJBX-4RG-15W-5CCT-WH-R	(Blank)	(Blank)
15W • 1,100lm • 120V	No Emergency	38°
LED-DLJBX-4RG-15W-5CCT-WH-R-0/10V	Backup	60D
15W • 1,100lm • 120-277V	EMB	60°
LED-DLJBX-4RG-18W-5CCT-WH-R	Emergency	
18W • 1,500lm • 120V	Backup	
LED-DLJBX-4RG-12W-3WD-WH-R		
12W • 850lm • 120V		

Optional Accessories (Order Separately)

Round Trim	Square Trim	New Construction Plates	Extension Cables	Emergency Backup (field install) 1	Goof Ring
DLJBX-4RG-TRIM-BLK-R Black Round	DLJBX-4RG-TRIM-WH-SQ White Square	CUNV-NC-ICAT-7H Universal Plate with Hanging Bars	JBX-EXT-6'-2PIN 6' Extension	LED-EMB-25W-HV -0/10V-2P	GR-4-WH 4"-8"
DLJBX-4RG-TRIM-BRZ-R Bronze Round	DLJBX-4RG-TRIM-BLK-SQ Black Squared	C4-JBX-RI 4" Rough in plate	JBX-EXT-10'-2PIN 10' Extension	Up to 24W fixtures	Width
	DLJBX-4RG-TRIM-BRZ-SQ Bronze Square	CUNV-JBX-RI-XL Universal Rough In Plate Extra Long	JBX-EXT-12'-2PIN 12' Extension		

1. Field installable. Lasts 90 minutes.

4" Regressed Downlight

5-CCT Selectable

FEATURES

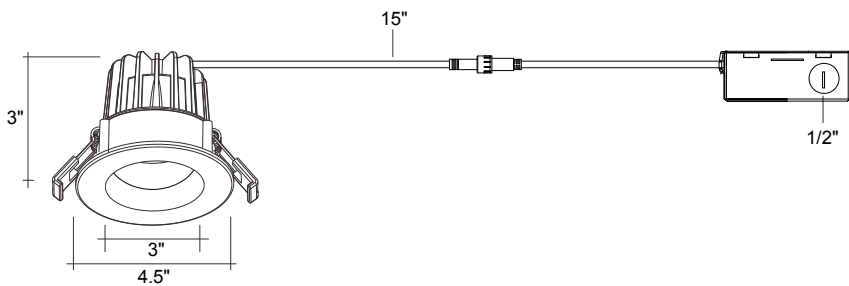
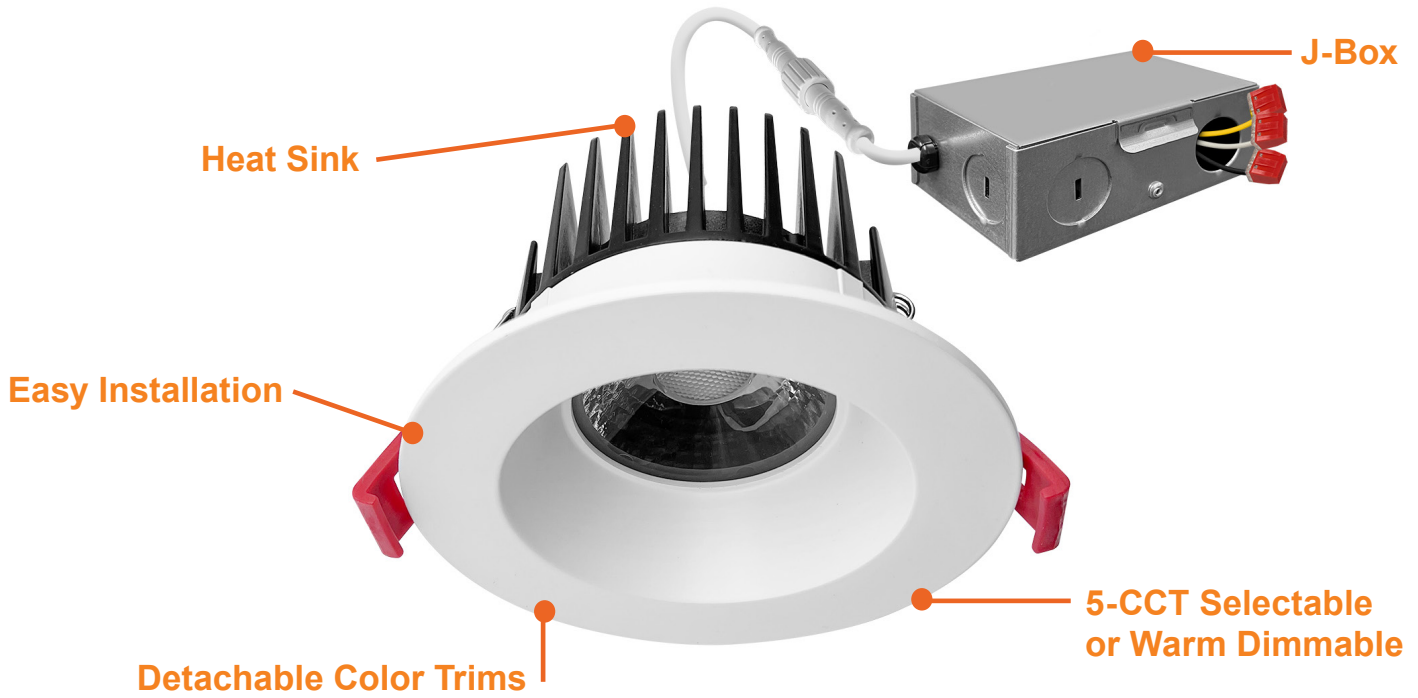

15W

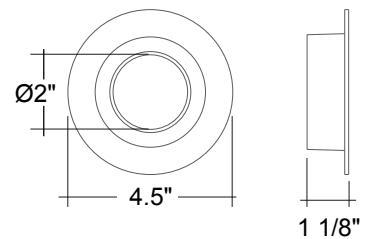

4" Round Trim

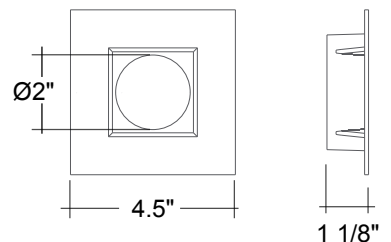
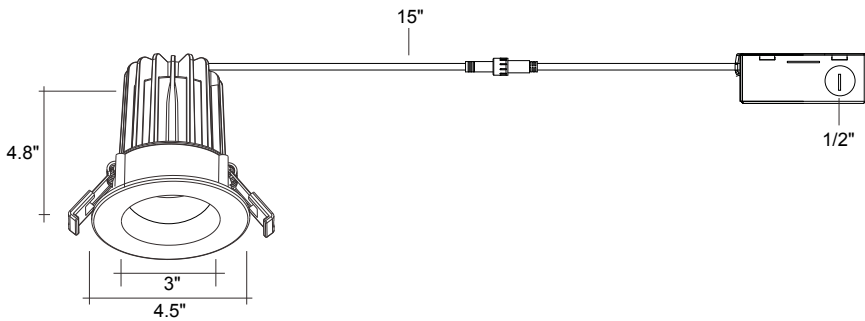

4" Square Trim

4" Regressed Downlight

5-CCT Selectable

ACCESSORIES



White (-WH)
Included



White (-WH-SQ)



Bronze (-BRZ-R)



Bronze (-BRZ-SQ)



Black (-BLK-R)



Black (-BLK-SQ)

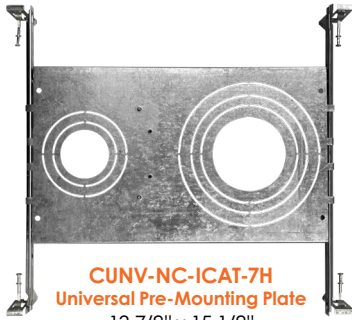

CUNV-NC-ICAT-7H
Universal Pre-Mounting Plate
13 7/8" x 15 1/8"

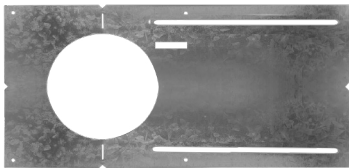

C4-JBX-RI
4" Rough In Plate
6 1/2" x 17 1/4"

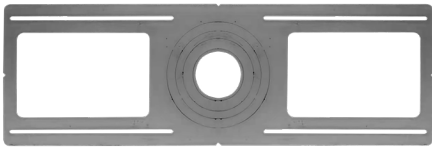

CUNV-JBX-RI-XL
7" x 26"



JBX-EXT
6' / 10' / 12' Extension Cable

TRIMS

Accessory	Description
Add '-EMB-' to model #	Emergency Backup (External 25W)
DLJBX-4RG-TRIM-WH-SQ	4" Regressed Gimbal White Square Trim
DLJBX-4RG-TRIM-BLK-R	4" Regressed Gimbal Black Round Trim
DLJBX-4RG-TRIM-BLK-SQ	4" Regressed Gimbal Black Square Trim
DLJBX-4RG-TRIM-BRZ-R	4" Regressed Gimbal Bronze Round Trim
DLJBX-4RG-TRIM-BRZ-SQ	4" Regressed Gimbal Bronze Square Trim

CONSTRUCTION PLATES

Accessory	Description
CUNV-NC-ICAT-7H	1" 2" 3" 3.5" 4" 5" 6" Universal Pre-Mounting New Construction Plate
C4-JBX-RI	4" Rough In Plate
CUNV-JBX-RI-XL	Universal tough in plate (Extra Long)

EXTENSION CABLE

Accessory	Description
JBX-EXT-6'-2PIN	6" Extension Cable
JBX-EXT-10'-2PIN	10" Extension Cable
JBX-EXT-12'-2PIN	12" Extension Cable

BATTERY BACK-UP

Accessory	Description
LED-EMB-25W-HV-0/10V-2P	Up to 24W fixtures

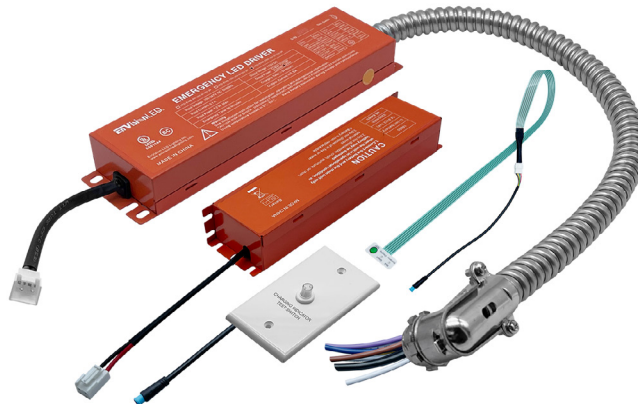

LED-EMB-25W-HV-0/10V-2P

