



Bi Level Motion Sensor w/ Daylight Harvesting

Twist-C Technology (Remote Required)



TECHNICAL DATA

OPERATING VOLTAGE	12±2V DC
OPERATING CURRENT	30mA
OUTPUT	DIM 0-10V
STAND-BY POWER	<0.5W
BRIGHTNESS	0%-100% Quick Setting: 70% / 80% / 90% / 100%
SENSITIVITY	20% / 50% / 75% / 100%
HOLD TIME	10s / 1min / 10min / 30min
DAYLIGHT THRESHOLD	10Lux / 30Lux / 50Lux / 100Lux / Disable
STAND-BY TIME	1min / 30min / 60min / +∞
STAND-BY DIMMING LEVEL	10% / 20% / 30% / 50%
MICROWAVE FREQUENCY	5.8GHz ± 75MHz
MICROWAVE POWER	<0.5mW
DETECTION ANGLE	150° (Wall Mounted) 360° (Ceiling Mounted)
CONTROL LINE	Pink: +12V; Purple: DIM+; Gray: GND/DIM-
MOUNTING HEIGHT	Max. 15m (Ceiling Mounted)
DETECTION RANGE	Max. Ø15m (Ceiling Mounted) Max. 20m (Wall Mounted)
OPERATING TEMPERATURE	-22°F ~ +140°F
IP RATING	IP65

NOTE

Default Setting: Brightness: 100%
 Hold Time: 1 min
 Stand-by Dimming Level: 20%
 Stand-by Time: 1 min
 Sensitivity: 100%
 Daylight: Disable



ON/OFF Control



Stand-By Dimming Level



Detection Area



Remote Control Settings



Hold Time

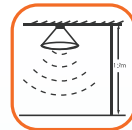

10-15M Highbay Height



Daylight Sensor



Stand-by Period

Series

HB01DMS-A

Bi Level Motion Sensor w/ Daylight Harvesting

Twist-C Technology (Remote Required)

INSTALLATION

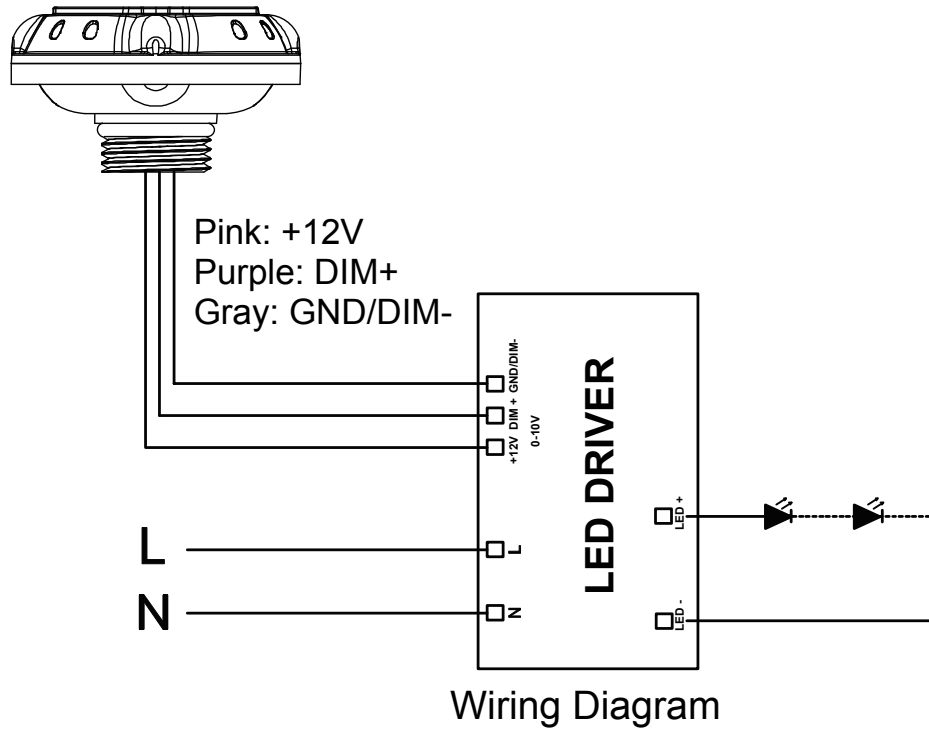

DIMENSIONS

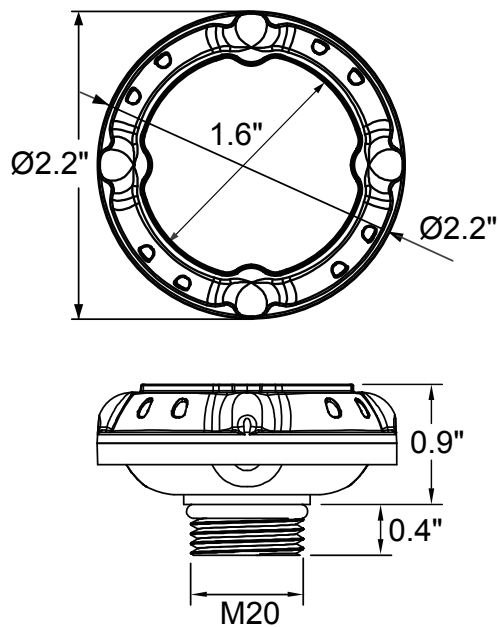

Bi Level Motion Sensor w/ Daylight Harvesting

Twist-C Technology (Remote Required)

REMOTE CONTROL



DISPLAY AREA

BRIGHTNESS (70% / 80% / 90% / 100%)
HOLD TIME (10s / 1 min. / 10 min. / 30 min.)
STANDBY DIM (10% / 20% / 30% / 50%)

STANDBY TIME (+ ∞ 1 min. / 30 min. / 60 min.)
SENSITIVITY (20% / 50% / 75% / 100%)
DAYLIGHT (10lx / 30lx / 50lx / 100lx)

BUTTON SETTING AREA

- ON/OFF** (Long press the ON/OFF button until the brightness indicator light is on. Press to turn on or off the fixture.)
- BRIGHTNESS** (Press to adjust dimming level 70% / 80% / 90% / 100%)
- SEND** (Press to save settings after each change. The indicator light confirms the save setting)
- HOLD TIME** (Press to adjust hold time 10s / 1 min. / 10 min. / 30 min.)
- DAYLIGHT** (Long press the button until the daylight indicator light is on, press to adjust daylight threshold 10lx / 30lx / 50lx / 100lx)
- SENSITIVITY** (Press to adjust sensitivity 20% / 50% / 75% / 100%) Note: PIR motion sensor have no sensitivity setting, default 100%
- STANDBY DIM** (Press to adjust stand-by dimming level 10% / 20% / 30% / 50%)
- STANDBY TIME** (Press to adjust stand-by time +∞ 1 min. / 30 min. / 60 min.)
 Note: "+∞" means unlimited stand-by time, and the light control mode is the light control priority mode, otherwise it's the light threshold mode.
- RESET** (Press the RESET button, products with DIP switch will be controlled by DIP switches; otherwise all the setting will change which is brightness 70% / hold time 10s / sensitivity 20% / daylight threshold disable / stand-by dimming level 10% stand-by time +∞)
- TEST** (The button "TEST" is for testing purpose after debugging. Pressing this button, the sensor goes to test mode (hold time is only 3s))
- Press to increase brightness (0-100%)
- Press to reduce brightness (100-0%)

ATTENTION

1. If you want to send a setting, it will only work if the remote control is on. If you don't press any button within 10 seconds, the indicator light will go out.
2. When using "ON/OFF" button, the rest buttons except the "ON/OFF", "BRIGHTNESS" and "SEND" buttons will be disabled.
3. When using "TEST" button, the rest buttons except the "TEST", "SENSITIVITY" and "SEND" buttons will be disabled.
4. Every change needs to press "SEND" button, it will be saved.
5. Because of the power supply "DIMMING" ratio difference, when using different power, "BRIGHTNESS" and "STANDBY DIM" adjust percentage of the power will have difference with the measured power.
6. Light control priority mode: The ON/OFF illumination values of each gear are: 10lx/50lx, 30lx/100lx, 50lx/150lx and 100lx/200lx
7. Light threshold mode: The ON/OFF illumination values of each gear is 10lx/30lx/50lx/100lx, when the light intensity is less than set value and the movement of someone or an object is included, the light is turned on to the preset brightness.

Series
HB03R

Bi Level Motion Sensor w/ Daylight Harvesting Twist-C Technology (Remote Required)

DETECTION COVERAGE

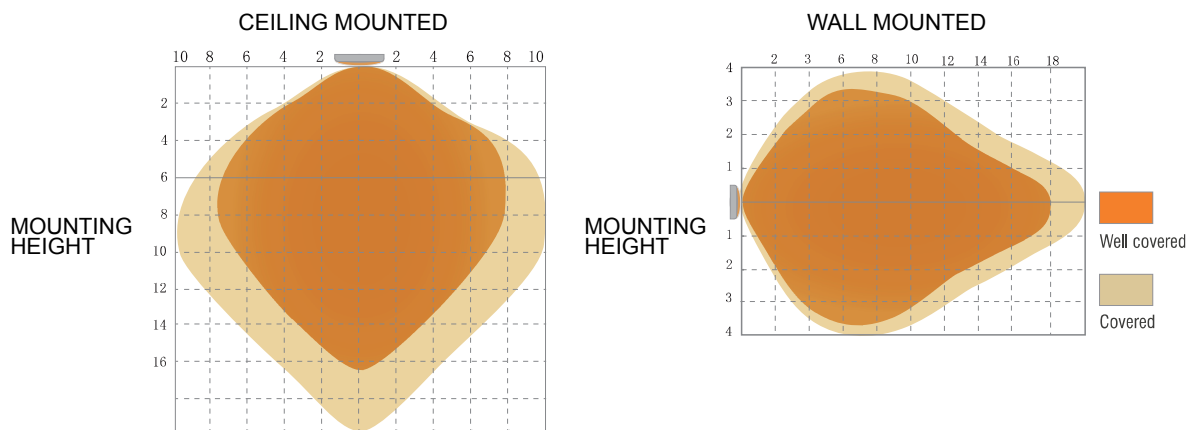

LUX ON/OFF

Adopted dual PD technology, HBO1DMS-A is able to differentiate artificial light brightness from natural light after installed inside the fixture, and automatically turn off light when ambient brightness exceeds preset lux level.

Preconditions to use the Lux-off function:

1. Stand-by period is $+\infty$
2. Stand-by dimming level is on 10%, 20%, 30% or 50%
3. Daylight threshold is on 10Lux, 30Lux, 50Lux or 100Lux

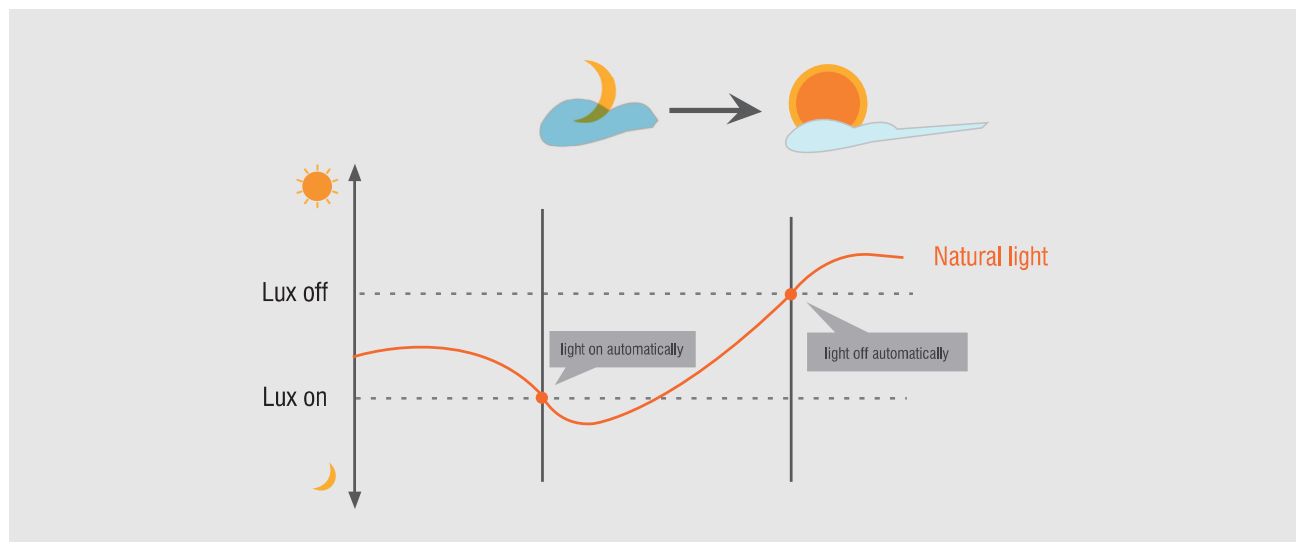

APPLICATION LUX ON/OFF

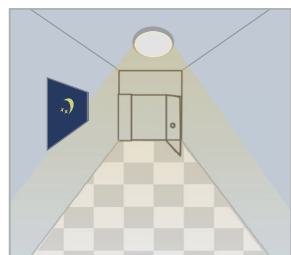

Light automatically on when ambient brightness is lower than preset lux level.



With insufficient ambient brightness, light dims to 100% when motion detected.

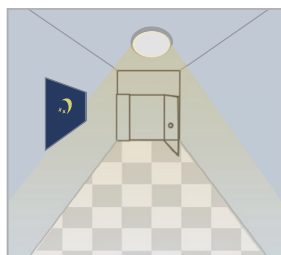

Light dims to stand-by level if no motion detected after hold time.

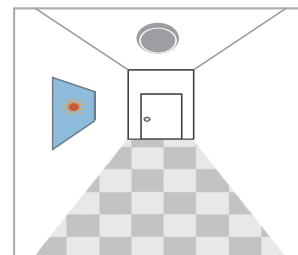

Light off when ambient lux level is higher than preset lux amount.