



H-Line: Bi Level Motion Sensor 1/2" Knock Out



TECHNICAL DATA

OPERATING VOLTAGE	120-277VAC, 50Hz/60Hz
SWITCHING CAPACITY	Max. 3.0A @ 120Vac, 50/60Hz Max. 2.0A @ 277Vac, 50/60Hz
STAND-BY POWER	<1W
DETECTION AREA	25% / 50% / 75% / 100%
HOLD TIME	5s / 30s / 1min / 3min / 5min / 10min / 20min / 30min
DAYLIGHT THRESHOLD	2Lux / 10Lux / 30Lux / 50Lux / 80Lux / 120Lux / Disable
STAND-BY PERIOD	0s / 10s / 30s / 1min / 5min / 10min / 30min +∞
STAND-BY DIMMING LEVEL	10% / 20% / 30% / 50%
MICROWAVE FREQUENCY	5.8GHz ± 75MHz
MICROWAVE POWER	<1mW
MOUNTING HEIGHT	Max. 15m (Ceiling Mounted)
DETECTION RANGE	Max. Ø14m
CONTROL LINE	Brown L, Blue N, Yellow L, Black -, Red +
OPERATING TEMPERATURE	-22°F ~ +140°F
IP RATING	IP65
DETECTION ANGLE	30° - 150°
SAFETY STANDARD	EN61347-1 EN61347-2-13 EN60598-1



ON/OFF Control



Stand-By Dimming Level



Detection Area



Remote Control Settings



Hold Time

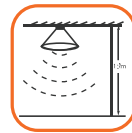

10-15M Highbay Height



Daylight Sensor



Stand-by Period

Series

HD406VRH-D-WH

H-Line: Bi Level Motion Sensor 1/2" Knock Out

INSTALLATION

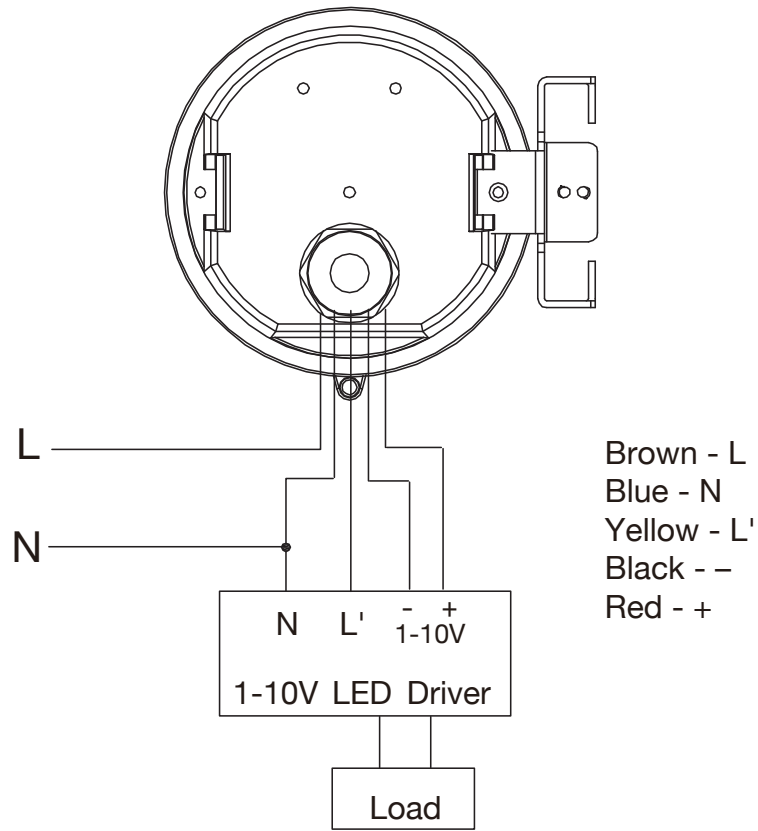

DIMENSIONS

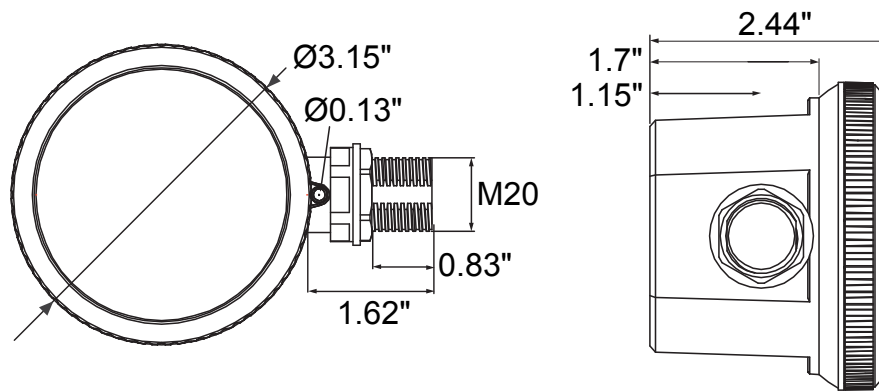

H-Line: Bi Level Motion Sensor 1/2" Knock Out

DETECTION COVERAGE

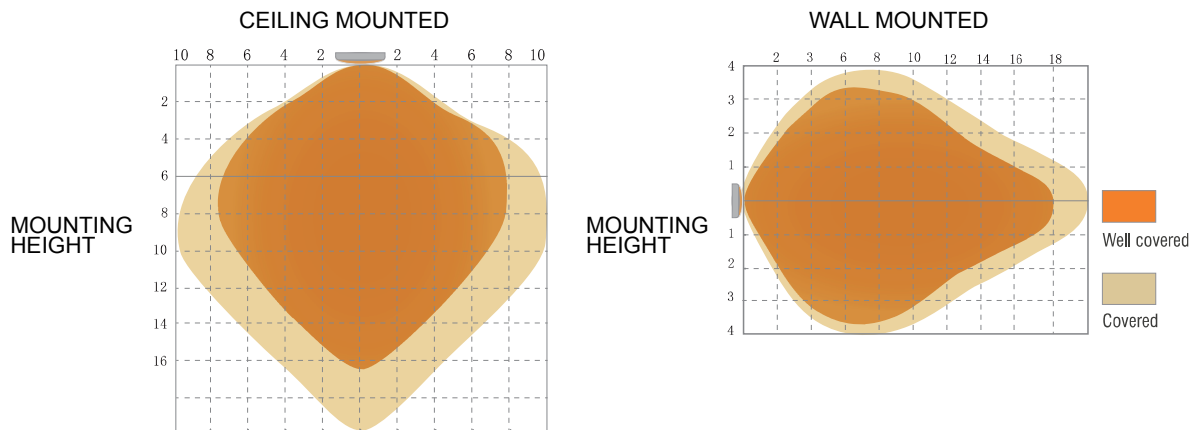

APPLICATION LUX ON/OFF

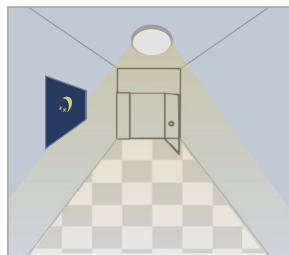

Light automatically on when ambient brightness is lower than preset lux level.



With insufficient ambient brightness, light dims to 100% when motion detected.

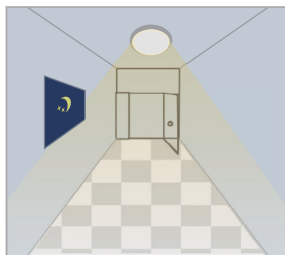

Light dims to stand-by level if no motion detected after hold time.

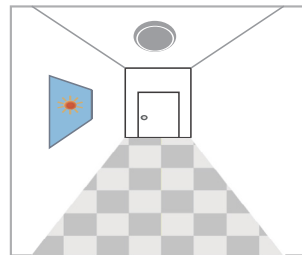

Light off when ambient lux level is higher than preset lux amount.



HD05R Remote Control

The EnVision HD05R remote controls IR-enabled fixtures with integrated sensors. The remote allows modifications to the settings of the sensors. This remote is compatible with the EnVision HD line of sensors.



Remote Keys	Keys Function	Keys Introduction
	ON/OFF	Switch ON/OFF the light; Switch OFF the sensor function.
	MW/PIR	Mode Switch
	Reset	Switch to sensor mode and recover all settings to be factory default setting (Detection area 100%, Hold time 5s, Daylight - Disable Stand-by period 0s, Stand-by dimming level 10%)
	Start	Press the key to start the setting of parameters with memory and apply function under the sensor mode. 1 Press "START", the letter "S" will flash in the lower lefty corner of the display, then start to set up all parameter. 2 After setting all parameters, press "MEMORY" to store settings and keep until the next reset. 3 Press "APPLY" to set the sensor with stored settings within the remote IR range 4 Note: All data shown in the display are the settings after pressing "MEMORY"
	Memory	
	Apply	
	Detection Area	
	Hold Time	Under sensor mode, press the key, the icon on the display flashes, press "+" / "-" to select the hold time. HD06VCRH 782: 5s/30s/1min/3min/5min/10min/20min/30min HD015VCRH: 5s/30s/1min/3min/5min/10min/20min/30min HB001VCR 1: 10s/1min/5min/10min HB002VCR: 5s/30s/1min/3min/5min/10min/20min/30min
	Daylight Threshold	Under sensor mode, press the key, the corresponding icon on the display flashes, press "+" / "-" to select the daylight threshold
	Stand-by Period	Under sensor mode, press the key, the corresponding icon on the display flashes, press "+" / "-" to select the low brightness time. HD06VCRH 782: 0s/10s/30s/1min/5min/10min/30min/60min + ∞ HD015VCRH: 0s/10s/30s/1min/5min/10min/30min + ∞ HB001VCR 1: 1min/30min/60min + ∞ HB002VCR: 0s/10s/30s/1min/5min/10min/30min/60min + ∞
	Stand-by Dimming Level	Under sensor mode, press the key, the corresponding icon on the display flashes, press "+" / "-" to select the brightness durint stand-by period

Series
HD05R