



Low Voltage: In-Ground Well Light

Solid Brass – Architectural Models



IGL-FL-BR-ORB



IGL-FL-BR-MBL



IGL-RB-BR-ORB



IGL-RB-BR-MBL



IGL-HM-BR-ORB



IGL-HM-BR-MBL



IGL-3L-BR-ORB



IGL-3L-BR-MBL

Detail Specifications:

- Finish: Oil Rubbed Bronze or Matte Black
- Housing: Corrosion Resistant Solid Brass
- Lamp Type:
 - MR-16 12V (not included)
 - 50W Halogen Max
 - LED bulbs available
- IP Rating: Wet Location IP68
- Lens: Clear Glass

Applications:

- Landscape
- Walkways & Pathways
- Driveways
- Hospitality, Multi-Family
- Outdoor Corridors
- General Outdoor Lighting
- Residential, Commercial

Product Information:

- Heat resistant glass lens
- Fully adjustable knuckle for precise control
- Water tight silicone ring for waterproofing
- Drive over rated
- Packaging: Retail color box
- Master box quantity: 10pcs.

Driver Options:

- Compatible with 12V Low Voltage Drivers

Mounting & Installations:

- Wire: 6' (72") SPT-1W 18 gauge wire lead

Warranty:

- Lifetime Anti-Corrosion Warranty

Oil Rubbed Bronze Models

- IGL-FL-BR-ORB-12V**
Flat Open Lens
- IGL-RB-BR-ORB-12V**
Ribbed Lens
- IGL-HM-BR-ORB-12V**
Half Moon Lens
- IGL-3L-BR-ORB-12V**
Hole Covered Lens

Matte Black Models

- IGL-FL-BR-MBL-12V**
Flat Open Lens
- IGL-RB-BR-MBL-12V**
Ribbed Lens
- IGL-HM-BR-MBL-12V**
Half Moon Lens
- IGL-3L-BR-MBL-12V**
Hole Covered Lens

1 Bulb Option (Not Included)

- | | | |
|--|--|--|
| LED-MR16-4W-27K-3B-BL
2700K • 350LM • 20/40/60° Adjustable | LED-MR16-5W-5CCT-4B-BL
530LM | LED-MR16-5W-27K
350lm • 40° • 35W Equivalent |
| LED-MR16-4W-30K-3B-BL
3000K • 350LM • 20/40/60° Adjustable | LED-MR16-8W-5CCT-4B-BL
700LM | LED-MR16-5W-30K
350lm • 40° • 35W Equivalent |
| LED-MR16-7W-27K-3B-BL
2700K • 600LM • 20/40/60° Adjustable | | LED-MR16-7W-27K
350lm • 40° • 35W Equivalent |
| LED-MR16-7W-30K-3B-BL
3000K • 600LM • 20/40/60° Adjustable | | LED-MR16-5W-40K
350lm • 40° • 35W Equivalent |
| | | LED-MR16-7W-30K
500lm • 40° • 50W Equivalent |
| | | LED-MR16-7W-40K
500lm • 40° • 50W Equivalent |

Specs and model numbers are subject to change with or without notice. Customization of product is available.



IGL-FL-BR-ORB



IGL-HM-BR-ORB



IGL-RB-BR-ORB



IGL-3L-BR-ORB

DIMENSIONS

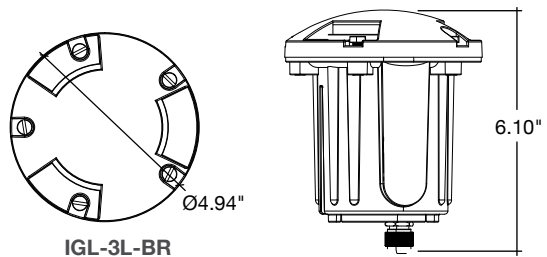
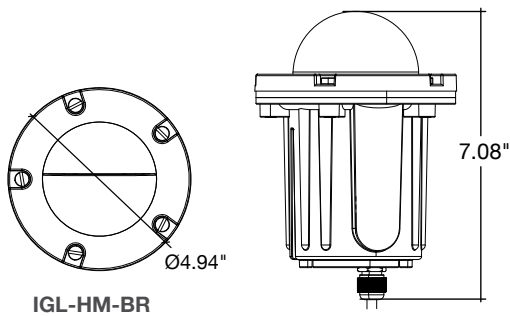
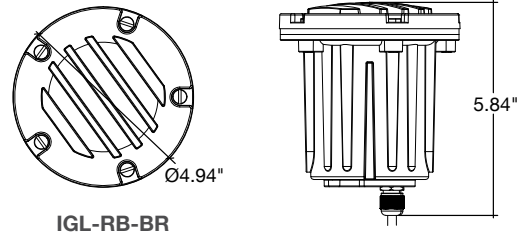
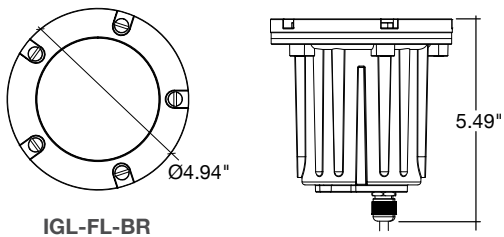

ACCESSORIES



MR16-5W-5CCT
MR16-8W-5CCT



MR16-4W (Adjustable)
MR16-7W (Adjustable)



MR16

Model	Voltage	Finish	Bulb
IGL-FL-BR-ORB-12V	12V	Oil Rubbed Bronze	LED-MR16
IGL-FL-BR-MBLB-12V	12V	Matte Black	LED-MR16
IGL-RB-BR-ORB-12V	12V	Oil Rubbed Bronze	LED-MR16
IGL-RB-BR-MBL-12V	12V	Matte Black	LED-MR16
IGL-HM-BR-ORB-12V	12V	Oil Rubbed Bronze	LED-MR16
IGL-HM-BR-MBL-12V	12V	Matte Black	LED-MR16
IGL-3L-BR-ORB-12V	12V	Oil Rubbed Bronze	LED-MR16
IGL-3L-BR-MBL-12V	12V	Matte Black	LED-MR16

BULBS

Model	Voltage	Watts	Lumens	Color
LED-MR16-5W-5CCT-4B-BL	12V	5w	530	50/40/35/30/27K
LED-MR16-8W-5CCT-4B-BL	12V	8w	700	50/40/35/30/27K
LED-MR16-4W-27K-3B-BL	12V	4w	350	2700k
LED-MR16-4W-30K-3B-BL	12V	4w	350	3000k
LED-MR16-7W-27K-3B-BL	12V	7w	600	2700k
LED-MR16-7W-30K-3B-BL	12V	4w	600	3000k
LED-MR16-5W-27K	12V	5w	350	2700k
LED-MR16-5W-30K	12V	5w	350	3000k
LED-MR16-5W-40K	12V	5w	350	4000k
LED-MR16-7W-27K	12V	7w	500	2700k
LED-MR16-7W-30K	12V	7w	500	3000k
LED-MR16-7W-40K	12V	7w	500	4000k