

# Arcy-Line: Architectural Linear Fixtures

5-CCT & 3-Power Selectable

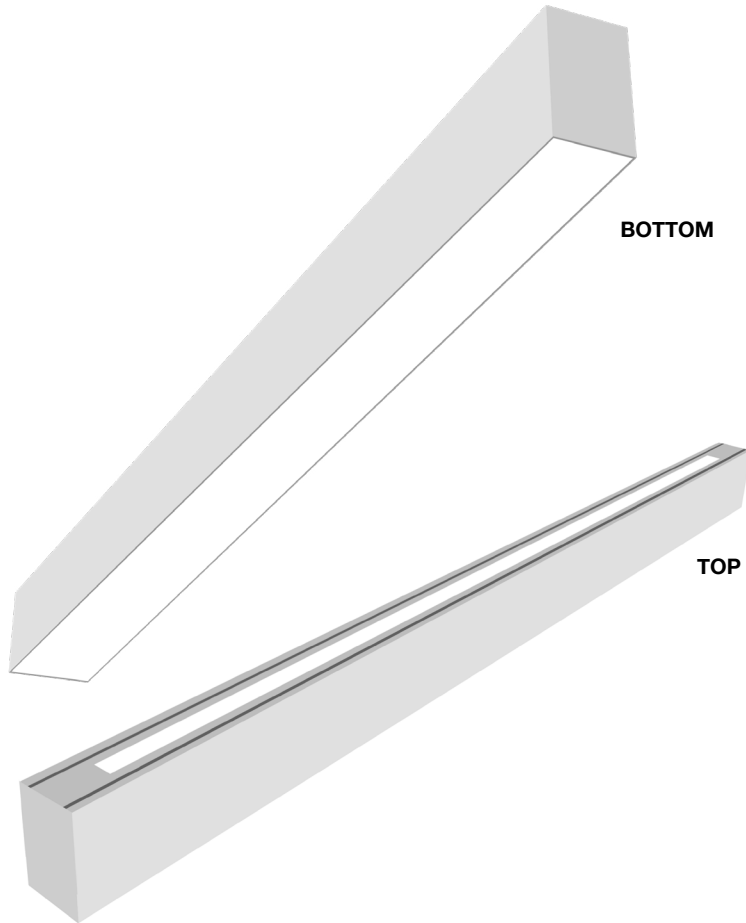

BOTTOM

TOP

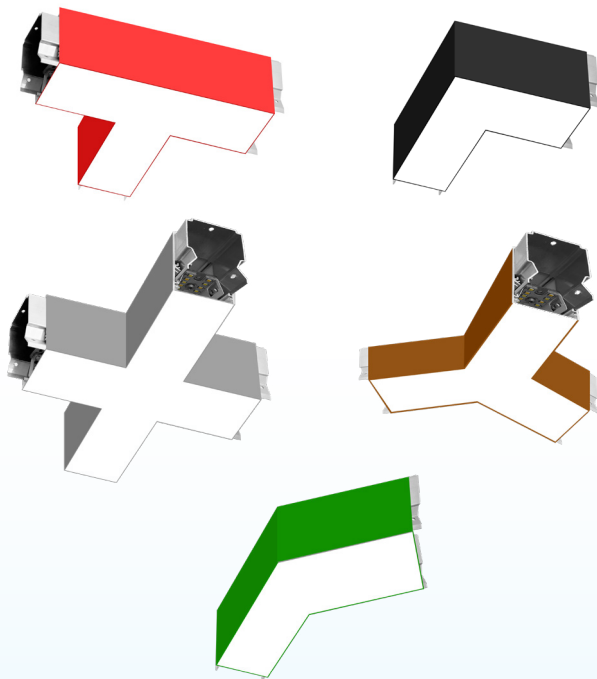

The ARCY-Line Direct/Indirect Architectural luminaires offer a 2" sleek and modern appearance with symmetrical light distribution. They can be surface, wall, recess, trimless, or pendant mounted. The luminaire provides flexible and creative illumination design options, including direct, indirect, and wall wash lighting, with fully illuminated corners for seamless connections between luminaires. It is designed to make an enduring impression in corporate offices, educational institutions, commercial spaces, and retail environments.

**Detail Specifications:**

- Finish: White, Custom finishes available
- IP Rating: Damp Location (IP44)
- Up & Down Beam Angle: 110°
- Chip: SMD 2835, R9 >50, CRI >90
- Operating Temperature: -4° - 114° F
- Lens: Acrylic Frosted Lens Standard: efficiently emits the light through a high-quality acrylic lens, spreading it evenly and without causing glare
- Optional Louver available
- Average life (L70) of 50,000 hours

**Applications:**

- Stairwell & Hallways
- Utility & Storage
- Garage Structures
- Office and Meeting Rooms
- Retail
- Commercial and Industrial

**Product Information:**

- Construction:
  - One piece aluminum extrusion housing that incorporates a precisely cut, smooth white extruded frosted lens that securely attaches to the body and allows easy removal for accessing the driver and LED boards when needed.
  - Solid aluminum end caps are included
  - Finished with corrosion free powder coat
- Fixture can be surface mounted or pendant mounted with
- Select-n-Switch Technology: 5-CCT + 3-Power Selectable

**Seamless Connection:**

- Fixture is pre-wired for easy daisy chain
- No additional wiring is required for continuous run
- Connector brackets to link fixtures in a continuous run is included

**Driver Options:**

- Max Run: 600W off one power feed
  - Maximum run by foot chart on page 3
- UNV: 100-277V 0-10V Dimmable (Dim-to-off)
- Optional 347-480V step down transformer available
- THD: <20% (+/-5% tolerance), PF >0.9, 50/60Hz
- 3-Power Selectable
- Flicker Free

**Mounting & Installation:**

- Suspend
- Surface Mount
- Wall Mount
- Trimless Mount (can be serviced from below ceiling)
- Recessed in Drywall
- Recessed in T-bar available (different SKU).

**Certifications:**

- ETL Listed for USA and CA
- DLC Standard Listed (Pending, ETA 02/2025)
- Approved for CA T24
- 5 Year Limited Warranty
- FCC CFR 47, GCC Part 15, Subpart B:2017

# ORDERING GUIDE

## LINEAR MODELS

Series	Length & Wattage	Light Direction	CCT	Finish <sup>1</sup>	Sensor	Emergency	Mounting Options
<b>LED-ALIN2</b> Architectural Linear	<b>1FT-3P12</b> 12/9/6W <b>2FT-3P25</b> 25/19/13W <b>3FT-3P38</b> 37.5/28/18w <b>4FT-3P50</b> 50/38/25W <b>6FT-3P75</b> 75/56/38W <b>8FT-3P100</b> 100/75/50W	<b>D</b> Downlight <b>UD</b> Downlight & Uplight  (View Chart for Lumens/Wattage)	<b>5CCT</b> 50/40/35 30/27K	<b>WH</b> White <b>CUSTOM<sup>1</sup></b> Custom Color View our RAL Chart	<b>(blank) BMS</b> Microwave Bi-Level <b>(blank) EMB</b> Emergency Backup	<b>(blank) RTK</b> Recessed drywall kit will be added to all 4 sides of the fixture. Choose this option for standalone fixtures. <b>RTK2</b> Recessed drywall kit will be added to the 2 long (length) of the fixture. Choose this option for the fixtures in the middle.	<b>RTK3</b> Recessed drywall kit will be added to the 2 long (length) and 1 short (width) of the fixture. Choose this option for the first and last fixtures on a run. <b>TML</b> Trimless kit will be added to all 4 sides of the fixture. Choose this option for standalone fixtures. <b>TML2</b> Trimless kit will be added to the 2 long (length) of the fixture. Choose this option for the first and last fixtures in the middle. <b>TML3</b> Trimless kit will be added to the 2 long (length) and 1 short (width) of the fixture. Choose this option for the first and last fixtures on a run.

1. White finish standard. Other colors are made to order appx. 10-15 working days. Replace "CS" with order code listed on available finishes (page 12).

## SPECIAL SHAPE MODELS

Series	Shape & Wattage	Light Direction	CCT	Finish <sup>1</sup>	Sensor	Emergency	Mounting Options
<b>LED-ALIN2</b> Architectural Linear	<b>12X12-L-3P25</b> L-Shape 25/19/13w <b>12X12-120L-3P25</b> 120° L-Shape 25/19/13w <b>24X24-L-3P50</b> L-Shape 50/38/25w <b>22x10-T-3P36</b> T-Shape 36/25/17w <b>22X22-X-3P50</b> X-Shape 50/38/25w	<b>D</b> Downlight <b>UD</b> Downlight & Uplight  (View Chart for Lumens/Wattage)	<b>5CCT</b> 50/40/35 30/27K	<b>WH</b> White <b>CUSTOM<sup>1</sup></b> Custom Color	<b>(blank) BMS</b> Microwave Bi-Level <b>(blank) EMB</b> Emergency Backup	<b>(blank) RTK</b> Recessed drywall kit will be added to all 4 sides of the fixture. Choose this option for standalone fixtures. <b>TML</b> Trimless kit will be added to all 4 sides of the fixture. Choose this option for standalone fixtures.	

1. White finish standard. Other colors are made to order appx. 10-15 working days. Replace "CS" with order code listed on available finishes (page 12).

## CONNECTORS

Connectors	CCT	Finish <sup>1</sup>	Mounting Options
<b>LED-ALIN2-L-5CCT</b> 8" L-Shape Connector	<b>5CCT</b> 27/30 35/40	<b>WH</b> White	<b>RTK</b> Recessed drywall kit will be added to all 4 sides of the fixture. Choose this option for standalone fixtures.
<b>LED-ALIN2-X-5CCT</b> 8" X-Shape Connector	50K	<b>CUSTOM<sup>1</sup></b> Custom Color	<b>TML</b> Trimless kit will be added sides of the fixture.
<b>LED-ALIN2-Y-5CCT</b> 8" Y-Shape Connector			
<b>LED-ALIN2-120L-5CCT</b> 8" 120° L-Shape Connector			

1. White finish standard. Other colors are made to order appx. 10-15 working days. Replace "CS" with order code listed on available finishes (page 12).

## ACCESSORIES

Suspension Canopy Kits	Suspension Rod Pendant Kits (Non-Adjustable)	Optional Installation Brackets	Up Light Kit (Field Installable)
<b>SK-CPR-12FT-1WR-WH</b> 12' Single Wire White Finish	<b>ALIN2-6FT-SRK-WH</b> 6' White Finish	<b>ALIN2-WM</b> Wall Mounting Brackets. Order 1 set for every 4 feet.	<b>ALIN2-2FT-UL</b> 5/4/2.5w
<b>SK-CPR-12FT-1WR-BL</b> 12' Single Wire Black Finish	<b>ALIN2-6FT-SRK-BL</b> 6' Black Finish		<b>ALIN2-4FT-UL</b> 10/8/5w

## ORDERING GUIDE

MAXIMUM RUN BY FOOT	
<b>POWER SETTING</b>	600W Max
<b>LOWEST</b>	96 Feet
<b>MIDDLE</b>	64 Feet
<b>HIGHEST</b>	48 Feet

WATTAGE BY FOOT	
<b>POWER SETTING</b>	
<b>LOWEST</b>	6.25W
<b>MIDDLE</b>	9.38 W
<b>HIGHEST</b>	12.5 W

### LUMENS CHART BY FOOT

DOWNLIGHT ONLY LUMENS/FT.	
<b>POWER SETTING</b>	<b>DOWNLIGHT</b>
<b>LOWEST</b>	750
<b>MIDDLE</b>	1,125
<b>HIGHEST</b>	1,500

DOWNLIGHT & UP LIGHT LUMENS/FT.		
<b>POWER SETTING</b>	<b>DOWNLIGHT</b>	<b>UP LIGHT</b>
<b>LOWEST</b>	600	150
<b>MIDDLE</b>	900	240
<b>HIGHEST</b>	1,200	300

### LUMENS CHART BY FIXTURE

3P12 MODELS					
DOWNLIGHT ONLY FIXTURE		DOWNLIGHT & UP LIGHT FIXTURE			
DOWNLIGHT		DOWNLIGHT		UP LIGHT	
WATT	LUMENS	WATT	LUMENS	WATT	LUMENS
6	750	5	600	1	120
9	1,080	7	840	2	240
12	1,500	9.5	1,200	2.5	300

3P25 MODELS					
DOWNLIGHT ONLY FIXTURE		DOWNLIGHT & UP LIGHT FIXTURE			
DOWNLIGHT		DOWNLIGHT		UP LIGHT	
WATT	LUMENS	WATT	LUMENS	WATT	LUMENS
13	1,560	10	1,200	3	360
19	2,280	15	1,800	4	480
25	3,000	20	2,400	5	600

**3P38 MODELS**

DOWNLIGHT ONLY FIXTURE		DOWNLIGHT & UP LIGHT FIXTURE			
DOWNLIGHT		DOWNLIGHT		UP LIGHT	
WATT	LUMENS	WATT	LUMENS	WATT	LUMENS
18	2,250	15	1,800	3	360
28	3,500	22.5	2,700	5.5	720
37.5	4,560	30	3,600	7.5	900

**3P50 MODELS**

DOWNLIGHT ONLY FIXTURE		DOWNLIGHT & UP LIGHT FIXTURE			
DOWNLIGHT		DOWNLIGHT		UP LIGHT	
WATT	LUMENS	WATT	LUMENS	WATT	LUMENS
25	3,000	20	2,400	5	600
37.5	4,500	30	3,600	8	960
50	6,000	40	4,800	10	1,200

**3P75 MODELS**

DOWNLIGHT ONLY FIXTURE		DOWNLIGHT & UP LIGHT FIXTURE			
DOWNLIGHT		DOWNLIGHT		UP LIGHT	
WATT	LUMENS	WATT	LUMENS	WATT	LUMENS
38	4,560	30	5,040	8	600
56	6,720	45	5,400	11	1,320
75	9,000	60	7,200	15	1,200

**3P100 MODELS**

DOWNLIGHT ONLY FIXTURE		DOWNLIGHT & UP LIGHT FIXTURE			
DOWNLIGHT		DOWNLIGHT		UP LIGHT	
WATT	LUMENS	WATT	LUMENS	WATT	LUMENS
50	6,000	40	4,800	10	1,200
75	9,000	60	7,200	15	1,800
100	12,000	80	9,600	20	2,400

Lumen based off 4000K. Other CCT: +/- 5%

## INSTALLATION METHODS

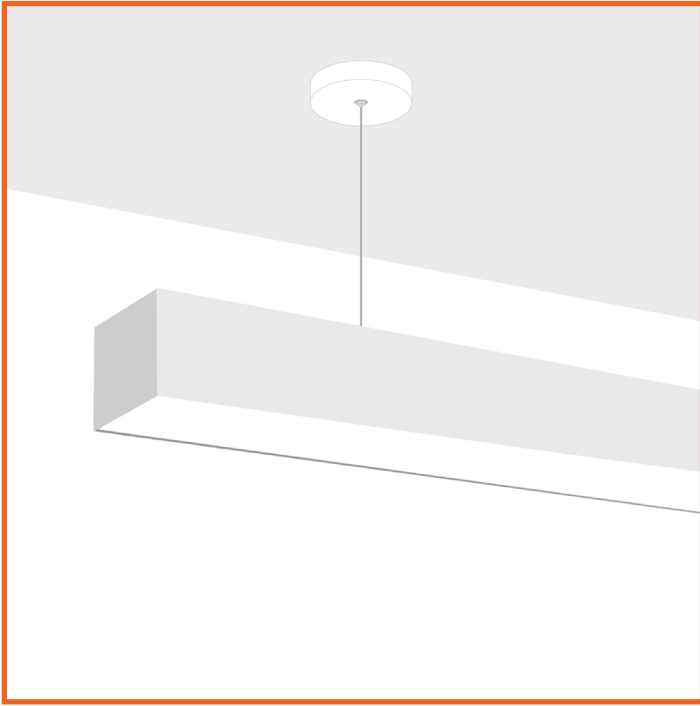

### Suspension Canopy Kits

The suspension kit can be adjusted in length. 5-wire power cord is included.



MODEL #	FINISH <sup>1</sup>
SK-6FT-CPR-1WR	<b>WH</b> White <b>BL</b> Black <b>CUSTOM</b> Custom Color View our RAL Chart
SK-12FT-CPR-1WR	

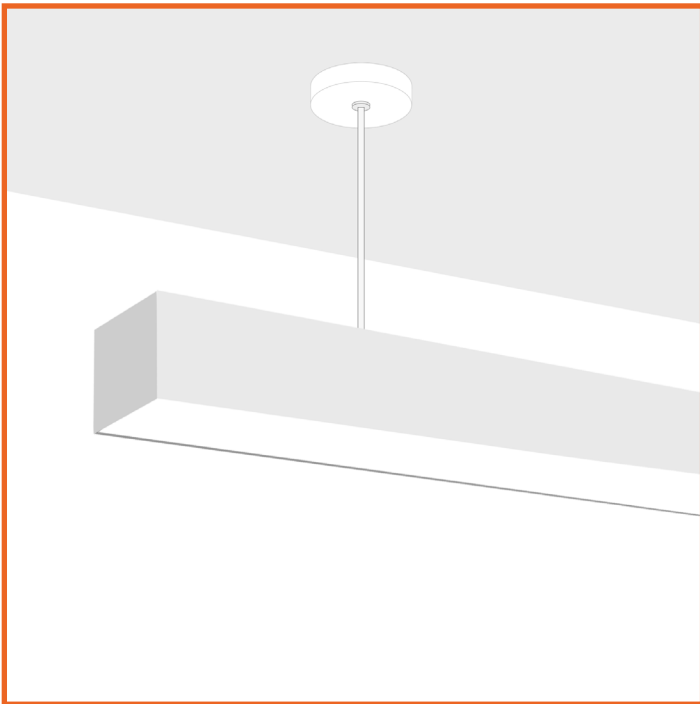

### Suspended (Stem/Rod Kit)

Suspend each fixture with a stem rod kit that can be adjusted to 2' or 4'. Available standard in white or black finish. Other paint options are available. Must order with the suspension kit canopy. Cord and canopy is not included.

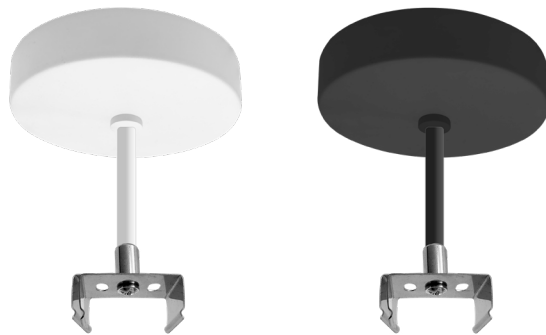

MODEL #	FINISH <sup>1</sup>
ALIN2-2/4FT-SRK	<b>WH</b> White <b>BL</b> Black <b>CUSTOM</b> Custom Color View our RAL Chart

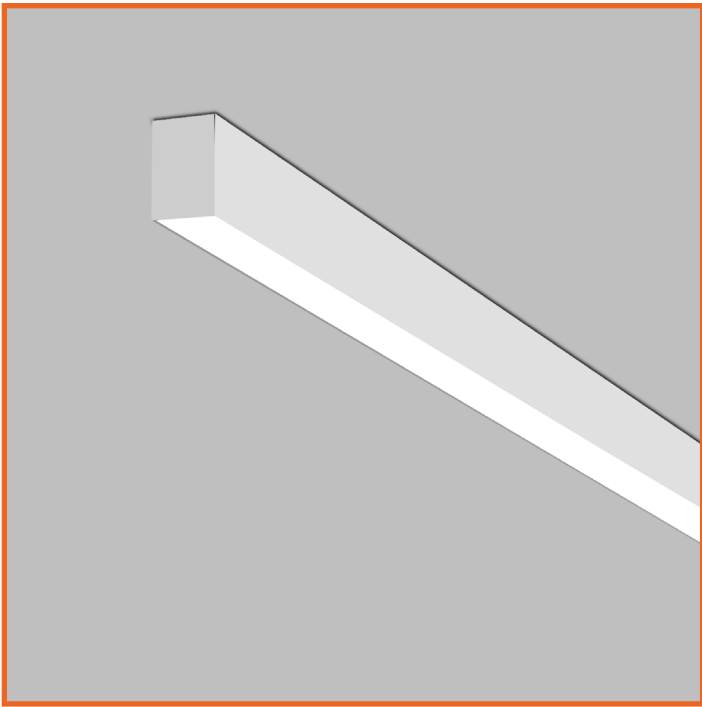

## Surface Mounted

Surface mount kit brackets are available for purchase. Use it to easily surface mount your fixtures into the ceiling.

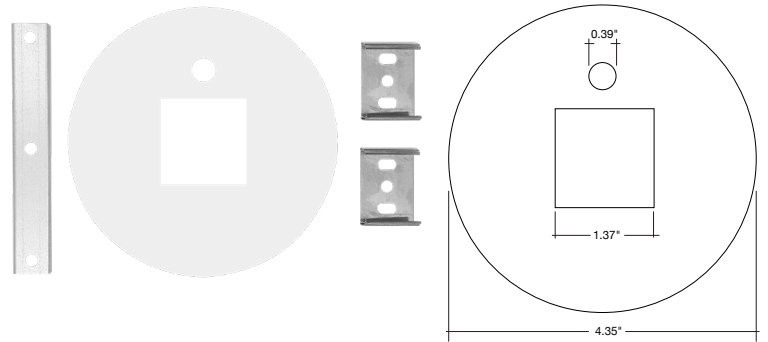

MODEL #	FINISH <sup>1</sup>
ALIN2-SM	<b>WH White</b> <b>CUSTOM</b> Custom Color View our RAL Chart



SHOWN WITH WALL MOUNT

## Wall Mount (Field Install Only)

Wall mounting brackets are available for field install. 2 brackets will be included per order. Wall mount will include a 4.5' power cord to install into the wall j-box.

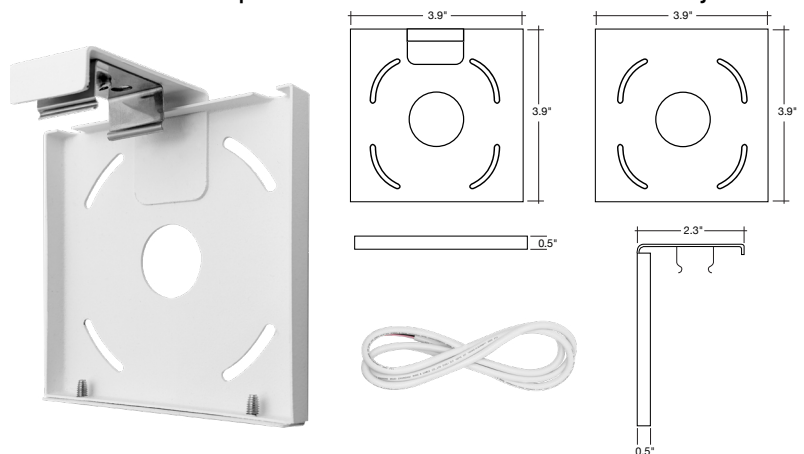

MODEL #	FINISH <sup>1</sup>
ALIN-WM	<b>WH White</b> <b>CUSTOM</b> Custom Color View our RAL Chart

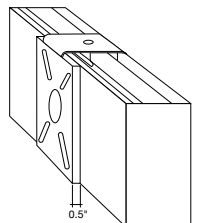



## Recessed Drywall Flange Kit (Factory Install Only)

Drywall recessed flange kit must be installed at the factory level. Bracket will allow for recessed and flush installation into drywall or other hard ceiling applications. Specify on your order:

- RTK:** Trim will be installed to all 4 corners of the fixture. Ideal for stand-alone fixtures.
- RTK2:** Trim will be installed to the 2 long (length) sides of the fixture. Ideal for middle fixtures in a continuous run.
- RTK3:** Trim will be installed to the 2 long (length) and 1 short (width) of the fixture. Ideal for the start or end of a continuous run. Recessed bracket will be included with each fixture.

This will not work in T-bar applications. For T-bar applications, use: LED-ALIN2-TB models (separate spec sheet).

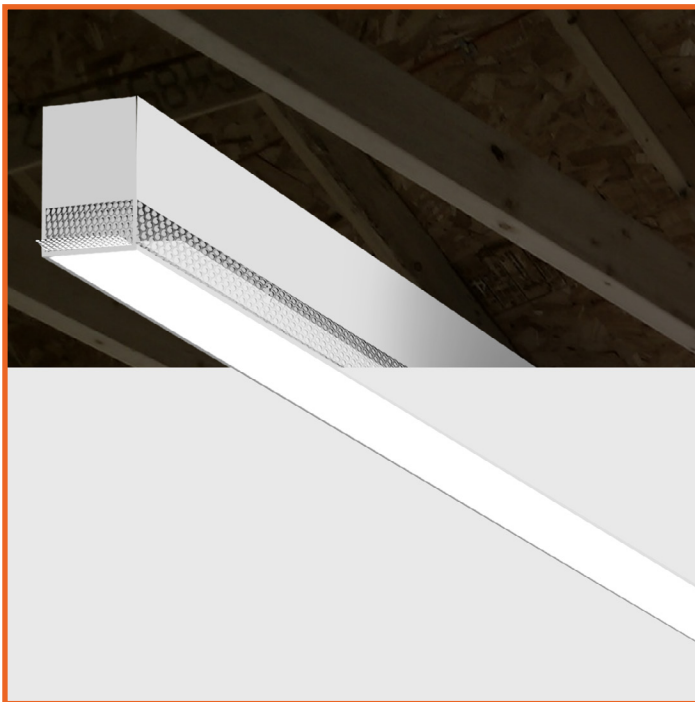
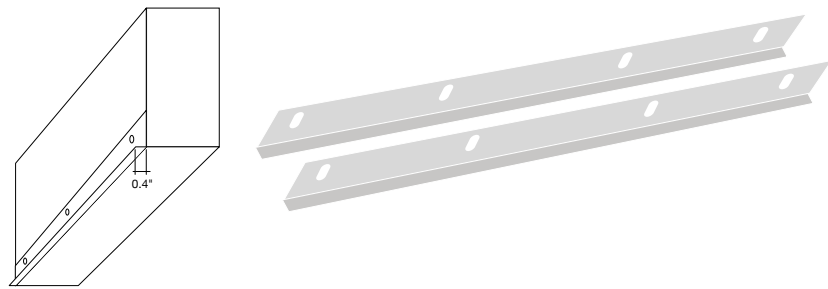

**RECESSED TRIMLESS**

## Trimless Recessed Kit (Factory Install Only)

Bracket will allow for trimless/mud-in installation. Bracket will add a 1/16" spacing from the lens to allow room for the mud in.

- TML:** Trim will be installed to all 4 corners of the fixture. Ideal for stand-alone fixtures
- TML2:** Trim will be installed to the 2 long (length) sides of the fixture. Ideal for middle fixtures in a continuous run.
- TML3:** Trim will be installed to the 2 long (length) and 1 short (width) of the fixture. Ideal for the start or end of a continuous run.

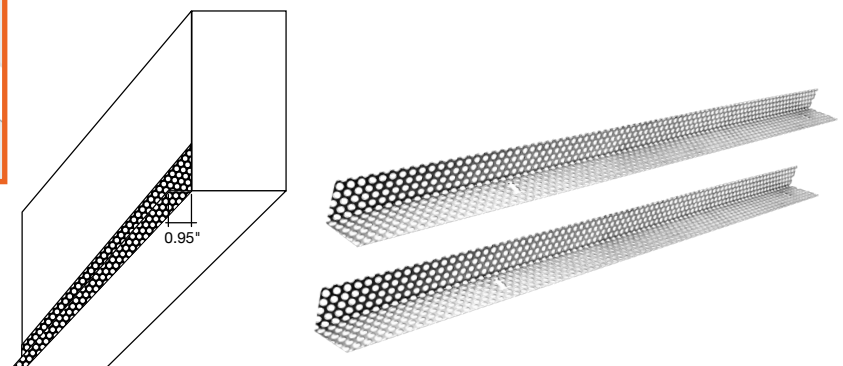

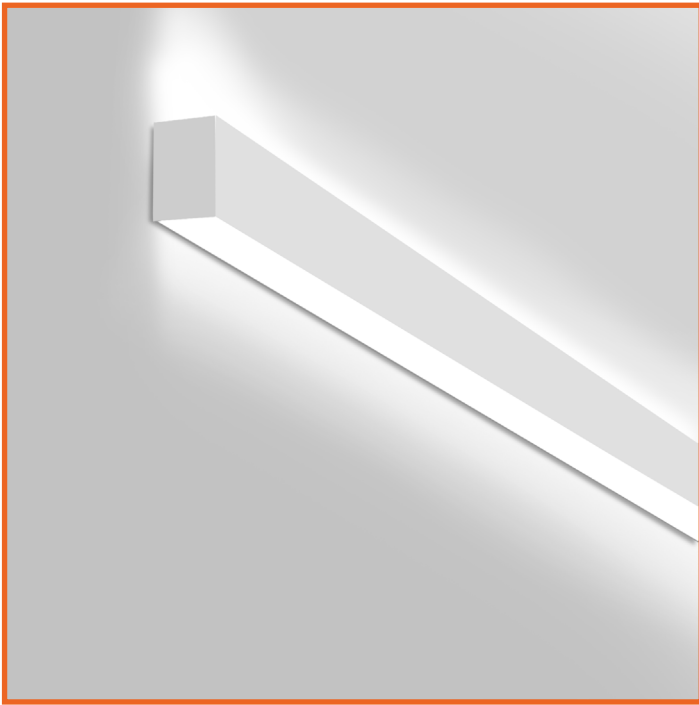

## Up Light Kit

**Model #'s: ALIN2-2FT-UL, ALIN2-4FT-UL**

This option can be field installed but is recommended to be factory installed. Up light is only available on fixtures 2' + length. Ordering guide for field install or stock check:

MODEL #	UP LIGHT MODEL #
LED-ALIN2-2FT-3P25	Qty 1: ALIN2-2FT-UL
LED-ALIN2-4FT-3P50	Qty 1: ALIN2-4FT-UL
LED-ALIN2-6FT-3P75	Qty 1: ALIN2-2FT-UL Qty 1: ALIN2-4FT-UL
LED-ALIN2-8FT-3P100	Qty 2: ALIN2-4FT-UL
LED-ALIN2-24X24-L-3P50	Qty 2: ALIN2-2FT-UL
LED-ALIN2-22X10-T-3P36	Qty 2: ALIN2-2FT-UL
LED-ALIN2-22X22-X-3P50	Qty 2: ALIN2-2FT-UL



# Arcy-Line: Architectural Linear Fixtures

## 5-CCT & 3-Power Selectable

### DIMENSIONS

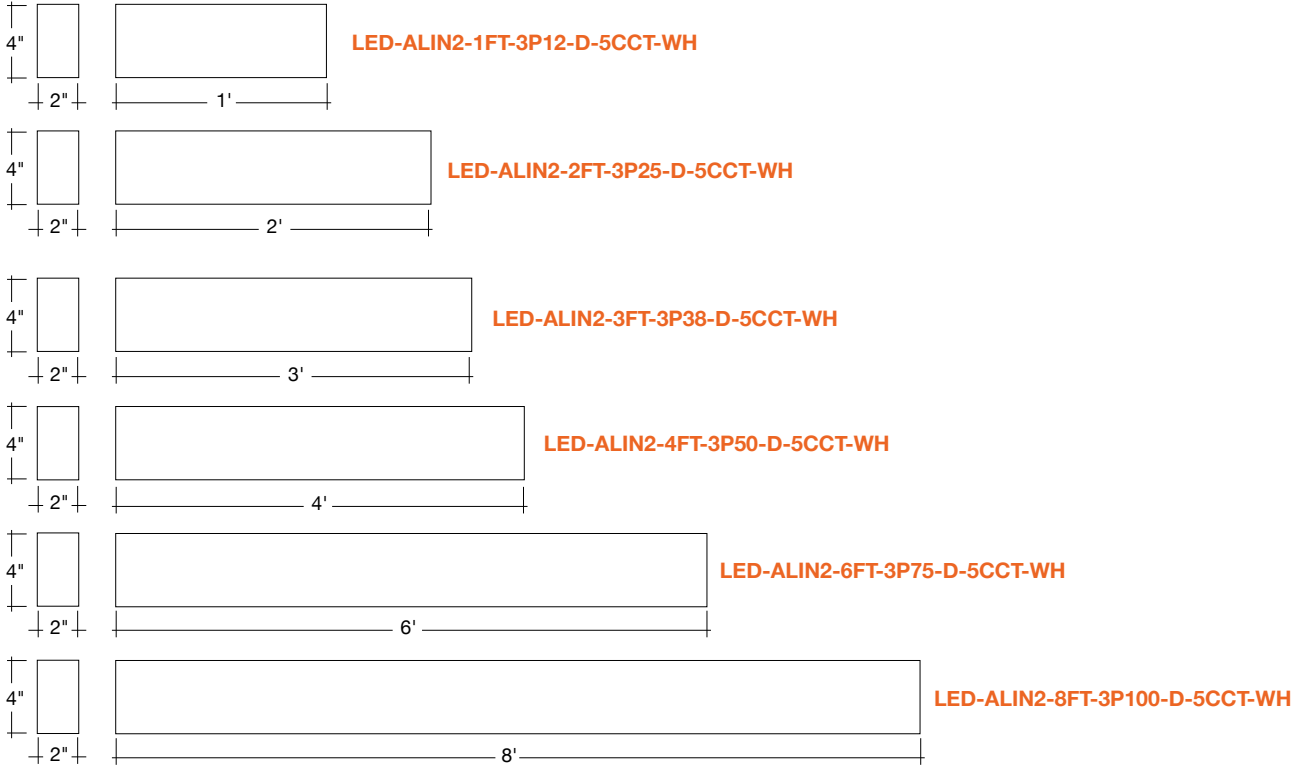

### DIMENSIONS

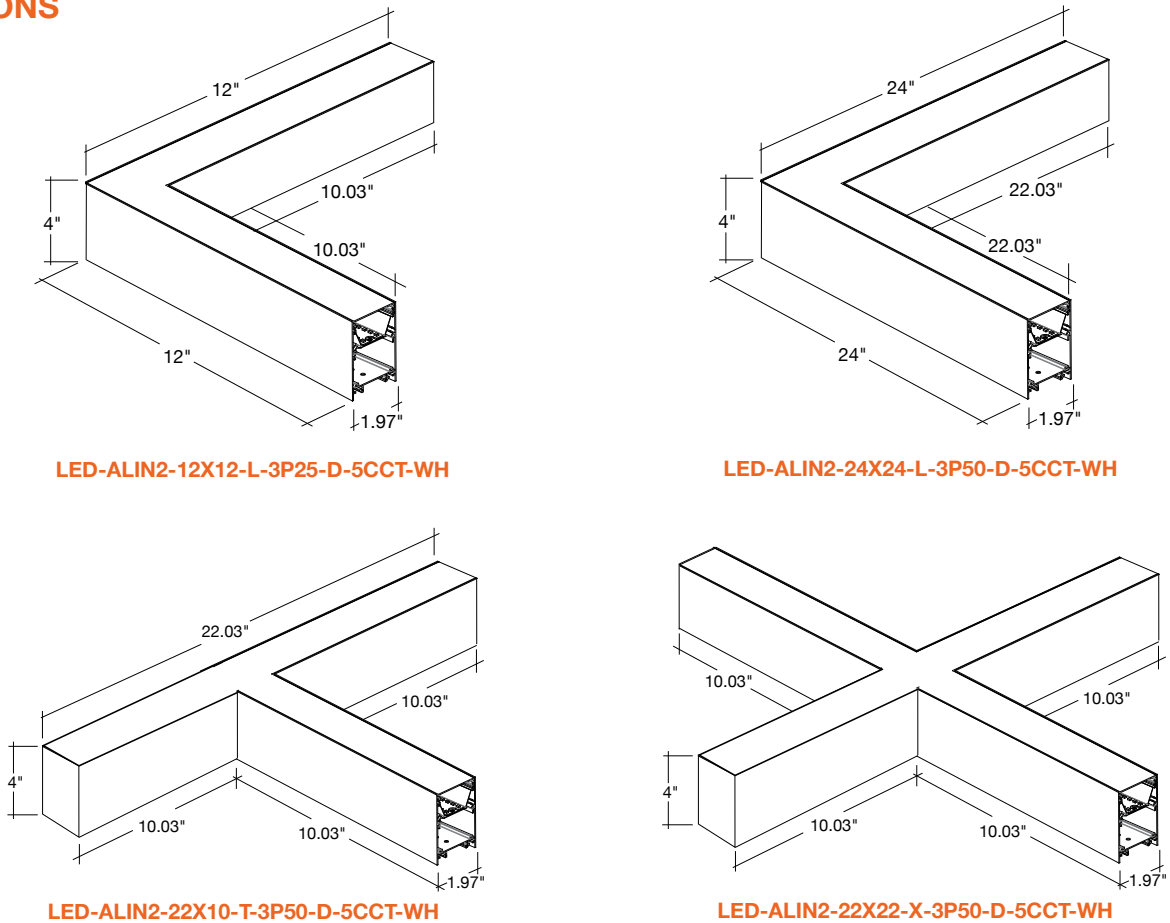

# Arcy-Line: Architectural Linear Fixtures

## 5-CCT & 3-Power Selectable

### DIMENSIONS

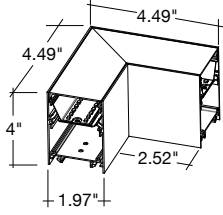

**LED-ALIN2-L-D-5CCT-WH**

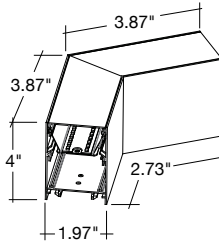

**LED-ALIN2-120L-D-5CCT-WH**

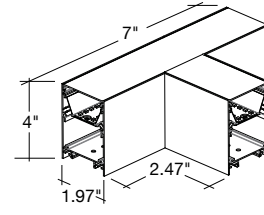

**LED-ALIN2-T-D-5CCT-WH**

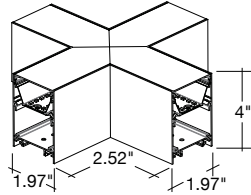

**LED-ALIN2-X-D-5CCT-WH**

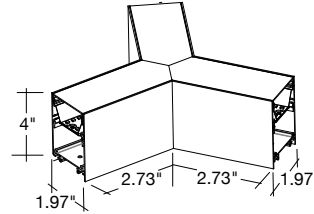

**LED-ALIN2-Y-D-5CCT-WH**

**2X2**

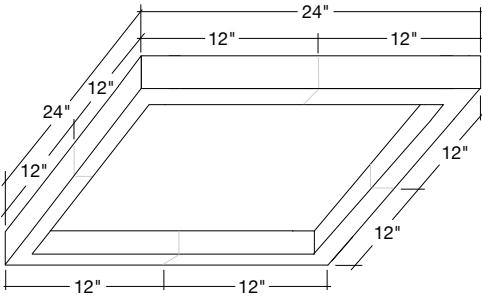

2' X 2' SQUARE	QTY.
LED-ALIN2-12X12-L-3P25-D-5CCT-WH	4

**3X3**

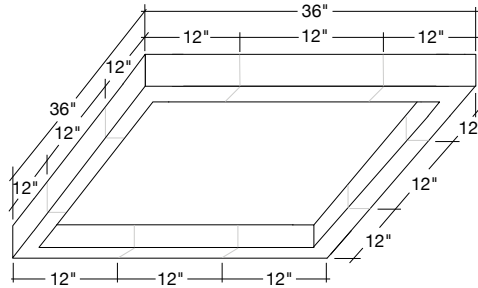

3' X 3' SQUARE	QTY.
LED-ALIN2-12X12-L-3P25-D-5CCT-WH	4
LED-ALIN2-12-I-3P12.5-D-5CCT-WH	4

**4X4**

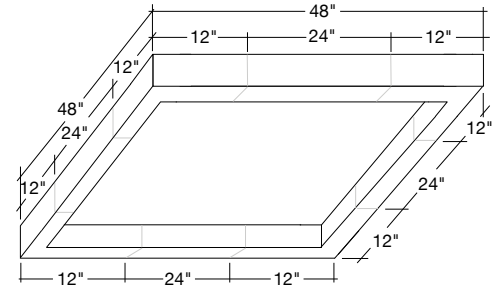

4' X 4' SQUARE	QTY.
LED-ALIN2-12X12-L-3P25-D-5CCT-WH	4
LED-ALIN2-24-I-3P25-D-5CCT-WH	4

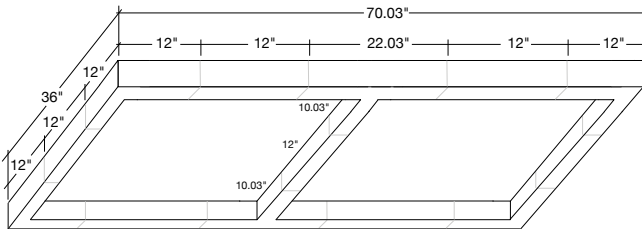

3' X 3' (2) SQUARE	QTY.
LED-ALIN2-12X12-L-3P25-D-5CCT-WH	4
LED-ALIN2-12-I-3P12.5-D-5CCT-WH	6
LED-ALIN2-22X10-T-3P50-D-5CCT-WH	2

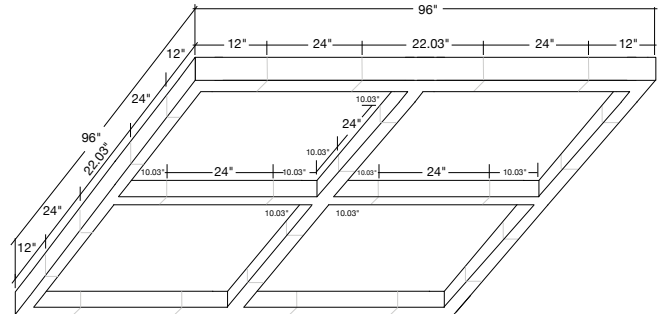

3' X 3' (4) SQUARE	QTY.
LED-ALIN2-12X12-L-3P25-D-5CCT-WH	4
LED-ALIN2-24-I-3P25-D-5CCT-WH	10
LED-ALIN2-22X10-T-3P50-D-5CCT-WH	4
LED-ALIN2-24X24-X-3P50-D-5CCT-WH	1

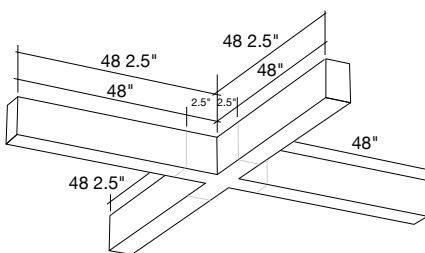

8' X 8' (X SHAPE)	QTY.
LED-ALIN2-48-I-3P50-D-5CCT-WH	4
LED-ALIN2-X-D-5CCT-WH	1

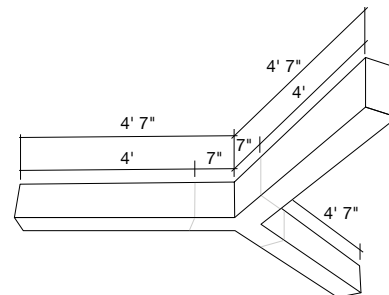

4' X 4' X 4' (Y SHAPE)	QTY.
LED-ALIN2-48-I-3P50-D-5CCT-WH	3
LED-ALIN2-Y-D-5CCT-WH	1

# Arcy-Line: Architectural Linear Fixtures

## 5-CCT & 3-Power Selectable

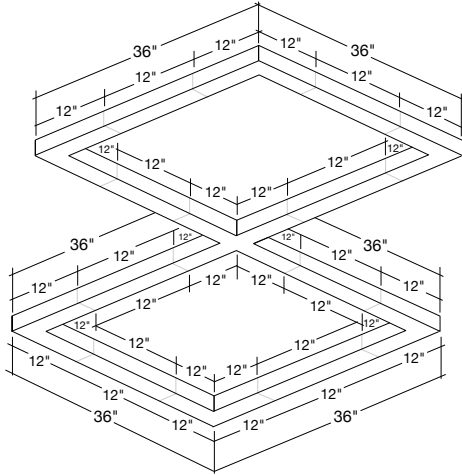

3' X 3' (2) SQUARE	QTY.
LED-ALIN2-12X12-L-3P25-D-5CCT-WH	6
LED-ALIN2-1FT-3P12-D-5CCT-WH	8
LED-ALIN2-24X24-X-3P50-D-5CCT-WH	1

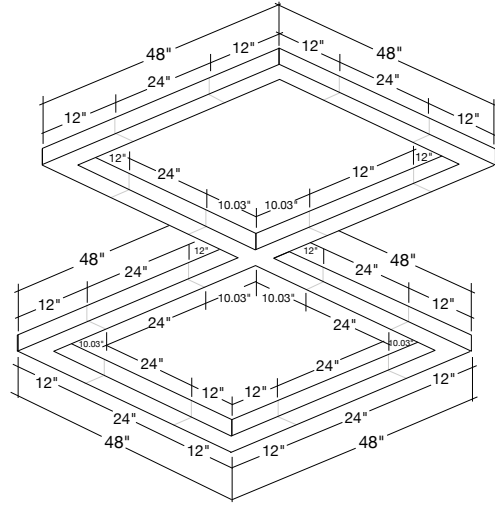

4' X 4' (2) SQUARE	QTY.
LED-ALIN2-12X12-L-3P25-D-5CCT-WH	6
LED-ALIN2-2FT-3P25-D-5CCT-WH	8
LED-ALIN2-24X24-X-3P50-D-5CCT-WH	1

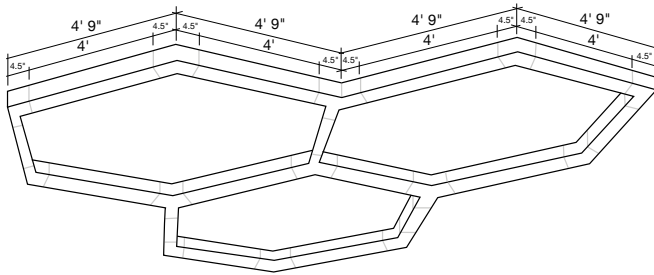

3' X 3' (3) TRIPLE HEXAGON	QTY.
LED-ALIN2-120L-D-5CCT-WH	9
LED-ALIN2-4FT-3P50-D-5CCT-WH	15
LED-ALIN2-Y-D-5CCT-WH	4

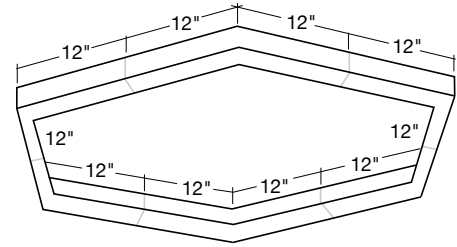

2' HEXAGON	QTY.
LED-ALIN2-12X12-120L-D-5CCT-WH	6

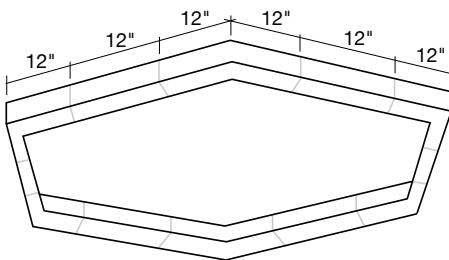

3' HEXAGON	QTY.
LED-ALIN2-12X12-120L-D-5CCT-WH	6
LED-ALIN2-1FT-3P12-D-5CCT-WH	6

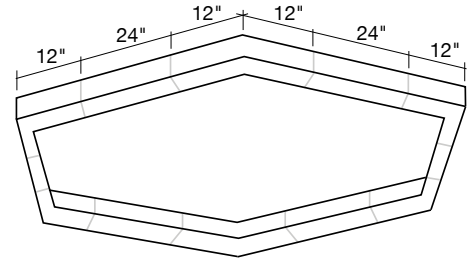

4' HEXAGON	QTY.
LED-ALIN2-12X12-120L-D-5CCT-WH	6
LED-ALIN2-2FT-3P25-D-5CCT-WH	6

# Arcy-Line: Architectural Linear Fixtures

## 5-CCT & 3-Power Selectable

**Powder Coat Colors & Finishes:** All fixtures are painted standard white RAL#9003. The below paint RAL# are available for an additional cost per fixture without additional set up fees. Custom RAL# not listed below are available but may require an additional set up fee.

### GLOSS OPTIONS

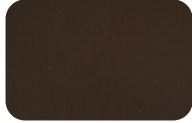

Statuary Bronze 60 Gloss  
T026-BR340  
Order Code: GL-BZ-1

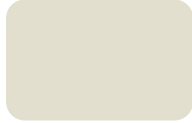

RAL 7042 Grey 80 Gloss  
T009-GR230  
Order Code: GL-GY-1



Silver Metallic 30 Gloss  
T353-GR06  
Order Code: GL-SL-1



Chrome Metallic 80 Gloss  
T358-GR539  
Order Code: GL-CH-1



Brass Metallic 30 Gloss  
T353-YL02  
Order Code: GL-BM-1



Dark Red 90 Gloss  
P009-RD02  
Order Code: GL-RD-1



Red 90 Gloss  
T009-RD01  
Order Code: GL-RD-2



Dark Yellow 90 Gloss  
T009-YL71  
Order Code: GL-YL-1



Yellow 90 Gloss  
T009-YL01  
Order Code: GL-YL-2

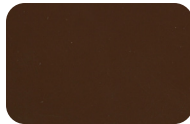

Terra Brown 90 Gloss  
(RAL8028) • C209-BR358  
Order Code: GL-BR-1



Traffic Green 70 Gloss  
T007-GN16  
Order Code: GL-GR-1



DOT Green 70 Gloss  
FS14066 • T007-GN13  
Order Code: GL-GR-2



Green 60 Gloss  
C006-GN03  
Order Code: GL-GR-3



Blue 90 Gloss  
T009-BL01  
Order Code: GL-BU-1



Light Blue 90 Gloss  
T009-BL05  
Order Code: GL-BU-2



Dark Blue 80 Gloss  
T008-BL20  
Order Code: GL-BU-3



Designer Beige 90 Gloss  
T009-BG16  
Order Code: GL-BG-1

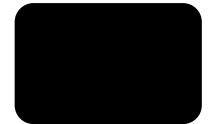

Black 10 Semi-Gloss  
T001-BK120  
Order Code: SGL-BL-1

### HAMMER OPTIONS



Black Hammer  
T013-BK62  
Order Code: HM-BL-1



Black Hammer Low Gloss  
E311-BK04  
Order Code: HM-BL-2

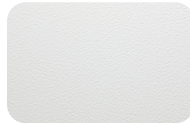

White Hammer  
T013-WH09  
Order Code: HM-WH-1



Red Hammer  
T013-RD15  
Order Code: HM-RD-1

### HAMMERTONE OPTIONS



Bronze Hammertone  
T064-BR24  
Order Code: HT-BZ-1



Silver Hammertone  
T064-GR05  
Order Code: HT-SL-1



Blue Hammertone  
T064-BL95  
Order Code: HT-BU-1



Green Hammertone  
T064-GN81  
Order Code: HT-GR-1

### VEIN OPTIONS

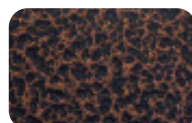

Copper Vein  
T375-BK07  
Order Code: VN-CP-1



Gold Vein  
T375-BK10  
Order Code: VN-GD-1

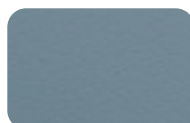

FS 25109 Blue Texture  
T032-BL04  
Order Code: TX-BU-1

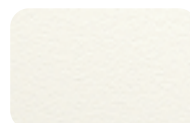

White Texture  
T032-WH15  
Order Code: TX-WH-1

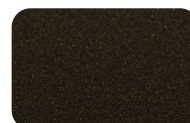

Oil Rubbed Bronze Texture  
T291-BR251  
Order Code: TX-BZ-1



Mock Rock Texture  
T091-GR309  
Order Code: TX-GY-1

### TEXTURE OPTIONS