

Arcy-Line: Architectural Linear Fixtures

5-CCT & 3-Power Selectable

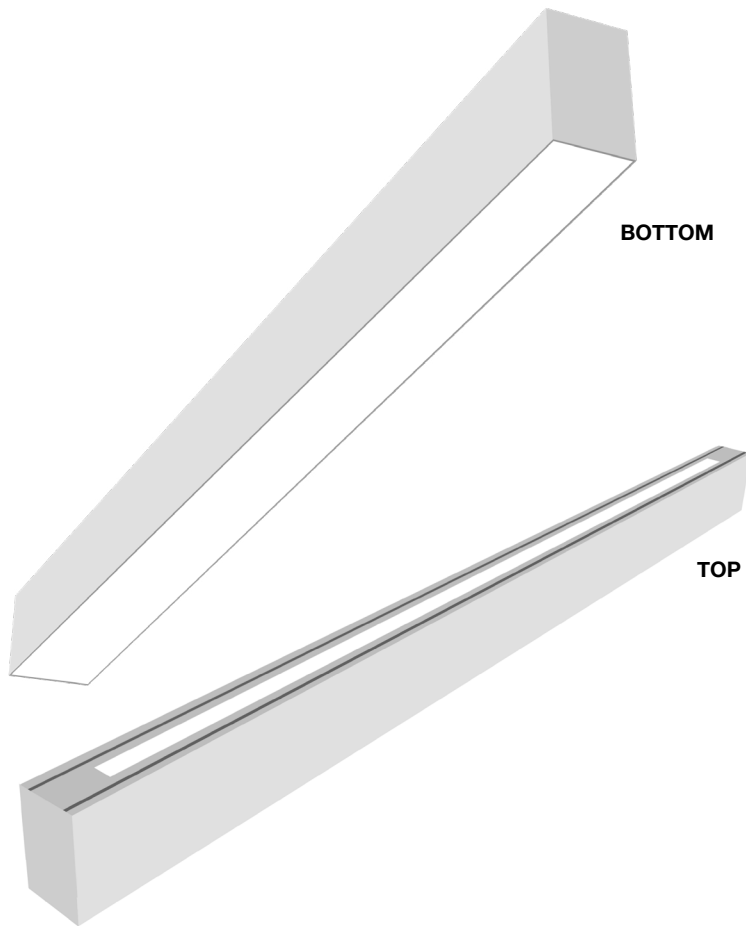

BOTTOM

TOP

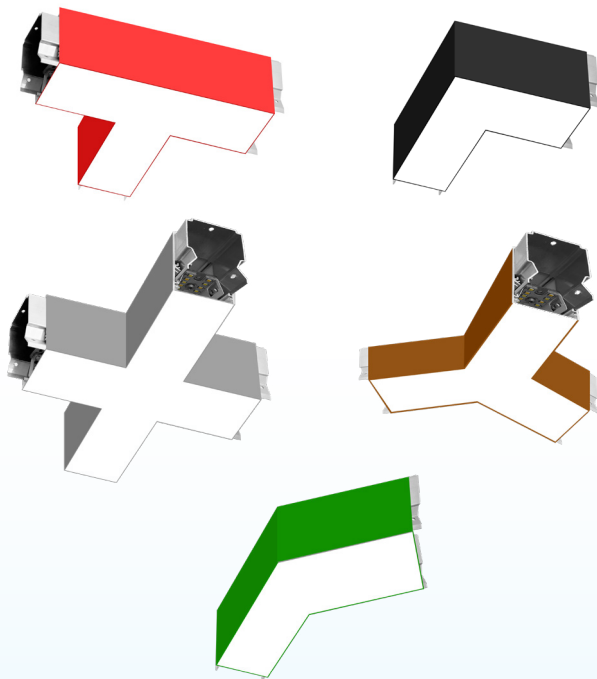

The ARCY-Line Direct/Indirect Architectural luminaires offer a 2" sleek and modern appearance with symmetrical light distribution. They can be surface, wall, recess, trimless, or pendant mounted. The luminaire provides flexible and creative illumination design options, including direct, indirect, and wall wash lighting, with fully illuminated corners for seamless connections between luminaires. It is designed to make an enduring impression in corporate offices, educational institutions, commercial spaces, and retail environments.

Detail Specifications:

- Finish: White, Custom finishes available
- IP Rating: Damp Location (IP44)
- Up & Down Beam Angle: 110°
- Chip: SMD 2835, R9 >50, CRI >90
- Operating Temperature: -4° - 114° F
- Lens: Acrylic Frosted Lens Standard: efficiently emits the light through a high-quality acrylic lens, spreading it evenly and without causing glare
- Optional Louver available
- Average life (L70) of 50,000 hours

Applications:

- Stairwell & Hallways
- Utility & Storage
- Garage Structures
- Office and Meeting Rooms
- Retail
- Commercial and Industrial

Product Information:

- Construction:
 - One piece aluminum extrusion housing that incorporates a precisely cut, smooth white extruded frosted lens that securely attaches to the body and allows easy removal for accessing the driver and LED boards when needed.
 - Solid aluminum end caps are included
 - Finished with corrosion free powder coat
- Fixture can be surface mounted or pendant mounted with
- Select-n-Switch Technology: 5-CCT + 3-Power Selectable

Seamless Connection:

- Fixture is pre-wired for easy daisy chain
- No additional wiring is required for continuous run
- Connector brackets to link fixtures in a continuous run is included

Driver Options:

- Max Run: 600W off one power feed
 - Maximum run by foot chart on page 3
- UNV: 100-277V 0-10V Dimmable (Dim-to-off)
- Optional 347-480V step down transformer available
- THD: <20% (+/-5% tolerance), PF >0.9, 50/60Hz
- 3-Power Selectable
- Flicker Free

Mounting & Installation:

- Suspend
- Surface Mount
- Wall Mount
- Trimless Mount (can be serviced from below ceiling)
- Recessed in Drywall
- Recessed in T-bar available (different SKU).

Certifications:

- ETL Listed for USA and CA
- DLC Standard Listed (Pending, ETA 02/2025)
- Approved for CA T24
- 5 Year Limited Warranty
- FCC CFR 47, GCC Part 15, Subpart B:2017

ORDERING GUIDE

LINEAR MODELS

| Series | Length & Wattage | Light Direction | CCT | Finish ¹ | Sensor | Emergency | Mounting Options |
|--|--|--|-----------------------------------|---|--|--|--|
| LED-ALIN2 Architectural Linear | 1FT-3P12 12/9/6W 2FT-3P25 25/19/13W 3FT-3P38 37.5/28/18w 4FT-3P50 50/38/25W 6FT-3P75 75/56/38W 8FT-3P100 100/75/50W | D Downlight UD Downlight & Uplight (View Chart for Lumens/Wattage) | 5CCT 50/40/35 30/27K | WH White CUSTOM¹ Custom Color View our RAL Chart | (blank) BMS Microwave Bi-Level (blank) EMB Emergency Backup | (blank) RTK Recessed drywall kit will be added to all 4 sides of the fixture. Choose this option for standalone fixtures. RTK2 Recessed drywall kit will be added to the 2 long (length) of the fixture. Choose this option for the fixtures in the middle. | RTK3 Recessed drywall kit will be added to the 2 long (length) and 1 short (width) of the fixture. Choose this option for the first and last fixtures on a run. TML Trimless kit will be added to all 4 sides of the fixture. Choose this option for standalone fixtures. TML2 Trimless kit will be added to the 2 long (length) and 1 short (width) of the fixture. Choose this option for the first and last fixtures on a run. TML3 Trimless kit will be added to the 2 long (length) and 1 short (width) of the fixture. Choose this option for the first and last fixtures on a run. |

1. White finish standard. Other colors are made to order appx. 10-15 working days. Replace "CS" with order code listed on available finishes (page 12).

SPECIAL SHAPE MODELS

| Series | Shape & Wattage | Light Direction | CCT | Finish ¹ | Sensor | Emergency | Mounting Options |
|--|--|--|-----------------------------------|---|--|--|------------------|
| LED-ALIN2 Architectural Linear | 12X12-L-3P25 L-Shape 25/19/13w 12X12-120L-3P25 120° L-Shape 25/19/13w 24X24-L-3P50 L-Shape 50/38/25w 22x10-T-3P36 T-Shape 36/25/17w 22X22-X-3P50 X-Shape 50/38/25w | D Downlight UD Downlight & Uplight (View Chart for Lumens/Wattage) | 5CCT 50/40/35 30/27K | WH White CUSTOM¹ Custom Color | (blank) BMS Microwave Bi-Level (blank) EMB Emergency Backup | (blank) RTK Recessed drywall kit will be added to all 4 sides of the fixture. Choose this option for standalone fixtures. TML Trimless kit will be added to all 4 sides of the fixture. Choose this option for standalone fixtures. | |

1. White finish standard. Other colors are made to order appx. 10-15 working days. Replace "CS" with order code listed on available finishes (page 12).

CONNECTORS

| Connectors | CCT | Finish ¹ | Mounting Options |
|---|-------------------------------|---|---|
| LED-ALIN2-L-5CCT 8" L-Shape Connector | 5CCT 27/30 35/40 | WH White | RTK Recessed drywall kit will be added to all 4 sides of the fixture. Choose this option for standalone fixtures. |
| LED-ALIN2-X-5CCT 8" X-Shape Connector | 50K | CUSTOM¹ Custom Color | TML Trimless kit will be added sides of the fixture. |
| LED-ALIN2-Y-5CCT 8" Y-Shape Connector | | | |
| LED-ALIN2-120L-5CCT 8" 120° L-Shape Connector | | | |

1. White finish standard. Other colors are made to order appx. 10-15 working days. Replace "CS" with order code listed on available finishes (page 12).

ACCESSORIES

| Suspension Canopy Kits | Suspension Rod Pendant Kits (Non-Adjustable) | Optional Installation Brackets | Up Light Kit (Field Installable) |
|---|--|--|----------------------------------|
| SK-CPR-12FT-1WR-WH 12' Single Wire White Finish | ALIN2-6FT-SRK-WH 6' White Finish | ALIN2-WM Wall Mounting Brackets. Order 1 set for every 4 feet. | ALIN2-2FT-UL 5/4/2.5w |
| SK-CPR-12FT-1WR-BL 12' Single Wire Black Finish | ALIN2-6FT-SRK-BL 6' Black Finish | | ALIN2-4FT-UL 10/8/5w |

ORDERING GUIDE

| MAXIMUM RUN BY FOOT | |
|----------------------|----------|
| POWER SETTING | 600W Max |
| LOWEST | 96 Feet |
| MIDDLE | 64 Feet |
| HIGHEST | 48 Feet |

| WATTAGE BY FOOT | |
|----------------------|--------|
| POWER SETTING | |
| LOWEST | 6.25W |
| MIDDLE | 9.38 W |
| HIGHEST | 12.5 W |

LUMENS CHART BY FOOT

| DOWNLIGHT ONLY LUMENS/FT. | |
|---------------------------|------------------|
| POWER SETTING | DOWNLIGHT |
| LOWEST | 750 |
| MIDDLE | 1,125 |
| HIGHEST | 1,500 |

| DOWNLIGHT & UP LIGHT LUMENS/FT. | | |
|---------------------------------|------------------|-----------------|
| POWER SETTING | DOWNLIGHT | UP LIGHT |
| LOWEST | 600 | 150 |
| MIDDLE | 900 | 240 |
| HIGHEST | 1,200 | 300 |

LUMENS CHART BY FIXTURE

| 3P12 MODELS | | | | | |
|------------------------|--------|------------------------------|--------|----------|--------|
| DOWNLIGHT ONLY FIXTURE | | DOWNLIGHT & UP LIGHT FIXTURE | | | |
| DOWNLIGHT | | DOWNLIGHT | | UP LIGHT | |
| WATT | LUMENS | WATT | LUMENS | WATT | LUMENS |
| 6 | 750 | 5 | 600 | 1 | 120 |
| 9 | 1,080 | 7 | 840 | 2 | 240 |
| 12 | 1,500 | 9.5 | 1,200 | 2.5 | 300 |

| 3P25 MODELS | | | | | |
|------------------------|--------|------------------------------|--------|----------|--------|
| DOWNLIGHT ONLY FIXTURE | | DOWNLIGHT & UP LIGHT FIXTURE | | | |
| DOWNLIGHT | | DOWNLIGHT | | UP LIGHT | |
| WATT | LUMENS | WATT | LUMENS | WATT | LUMENS |
| 13 | 1,560 | 10 | 1,200 | 3 | 360 |
| 19 | 2,280 | 15 | 1,800 | 4 | 480 |
| 25 | 3,000 | 20 | 2,400 | 5 | 600 |

3P38 MODELS

| DOWNLIGHT ONLY FIXTURE | | DOWNLIGHT & UP LIGHT FIXTURE | | | |
|------------------------|--------|------------------------------|--------|----------|--------|
| DOWNLIGHT | | DOWNLIGHT | | UP LIGHT | |
| WATT | LUMENS | WATT | LUMENS | WATT | LUMENS |
| 18 | 2,250 | 15 | 1,800 | 3 | 360 |
| 28 | 3,500 | 22.5 | 2,700 | 5.5 | 720 |
| 37.5 | 4,560 | 30 | 3,600 | 7.5 | 900 |

3P50 MODELS

| DOWNLIGHT ONLY FIXTURE | | DOWNLIGHT & UP LIGHT FIXTURE | | | |
|------------------------|--------|------------------------------|--------|----------|--------|
| DOWNLIGHT | | DOWNLIGHT | | UP LIGHT | |
| WATT | LUMENS | WATT | LUMENS | WATT | LUMENS |
| 25 | 3,000 | 20 | 2,400 | 5 | 600 |
| 37.5 | 4,500 | 30 | 3,600 | 8 | 960 |
| 50 | 6,000 | 40 | 4,800 | 10 | 1,200 |

3P75 MODELS

| DOWNLIGHT ONLY FIXTURE | | DOWNLIGHT & UP LIGHT FIXTURE | | | |
|------------------------|--------|------------------------------|--------|----------|--------|
| DOWNLIGHT | | DOWNLIGHT | | UP LIGHT | |
| WATT | LUMENS | WATT | LUMENS | WATT | LUMENS |
| 38 | 4,560 | 30 | 5,040 | 8 | 600 |
| 56 | 6,720 | 45 | 5,400 | 11 | 1,320 |
| 75 | 9,000 | 60 | 7,200 | 15 | 1,200 |

3P100 MODELS

| DOWNLIGHT ONLY FIXTURE | | DOWNLIGHT & UP LIGHT FIXTURE | | | |
|------------------------|--------|------------------------------|--------|----------|--------|
| DOWNLIGHT | | DOWNLIGHT | | UP LIGHT | |
| WATT | LUMENS | WATT | LUMENS | WATT | LUMENS |
| 50 | 6,000 | 40 | 4,800 | 10 | 1,200 |
| 75 | 9,000 | 60 | 7,200 | 15 | 1,800 |
| 100 | 12,000 | 80 | 9,600 | 20 | 2,400 |

Lumen based off 4000K. Other CCT: +/- 5%

INSTALLATION METHODS

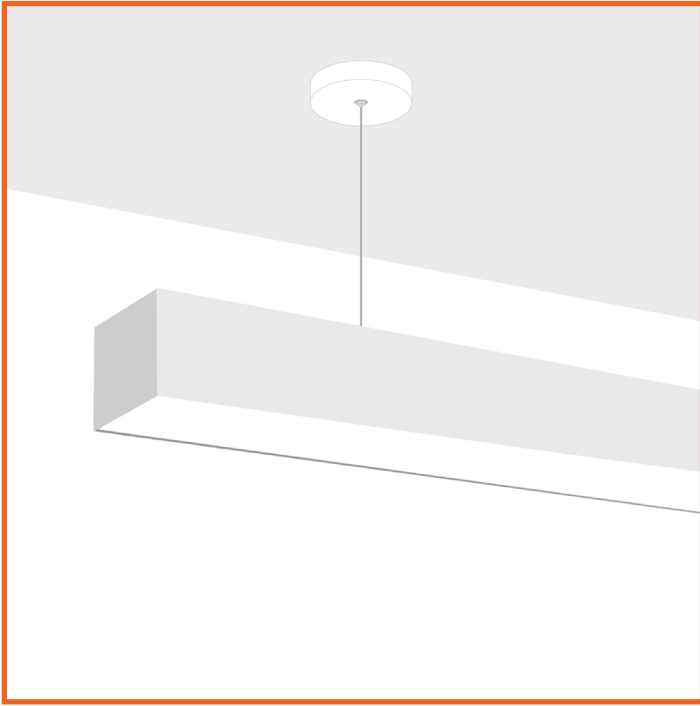

Suspension Canopy Kits

The suspension kit can be adjusted in length. 5-wire power cord is included.



| MODEL # | FINISH ¹ |
|-----------------|---|
| SK-6FT-CPR-1WR | WH White BL Black CUSTOM Custom Color View our RAL Chart |
| SK-12FT-CPR-1WR | |

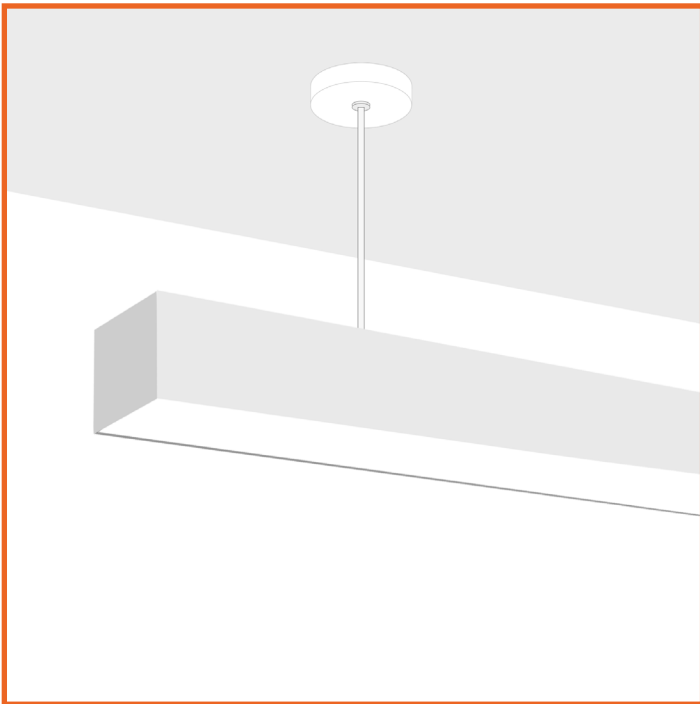

Suspended (Stem/Rod Kit)

Suspend each fixture with a stem rod kit that can be adjusted to 2' or 4'. Available standard in white or black finish. Other paint options are available. Must order with the suspension kit canopy. Cord and canopy is not included.



| MODEL # | FINISH ¹ |
|-----------------|---|
| ALIN2-2/4FT-SRK | WH White BL Black CUSTOM Custom Color View our RAL Chart |
| | |

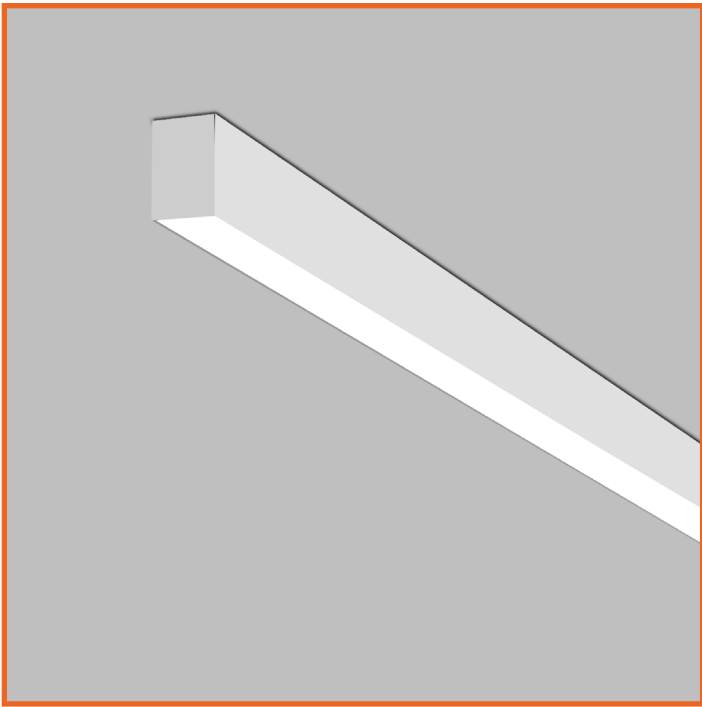

Surface Mounted

Surface mount kit brackets are available for purchase. Use it to easily surface mount your fixtures into the ceiling.

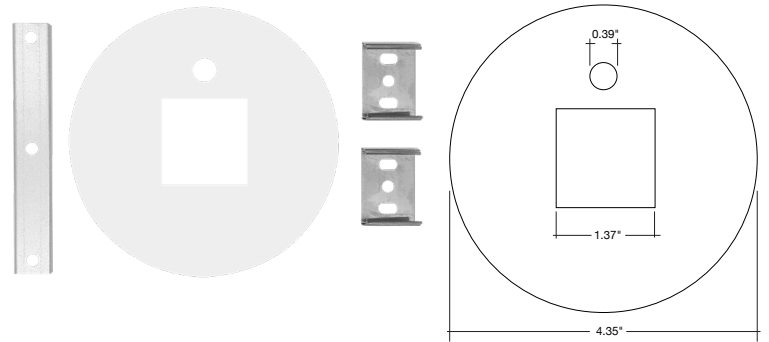

| MODEL # | FINISH ¹ |
|----------|--|
| ALIN2-SM | WH White CUSTOM Custom Color View our RAL Chart |



SHOWN WITH WALL MOUNT

Wall Mount (Field Install Only)

Wall mounting brackets are available for field install. 2 brackets will be included per order. Wall mount will include a 4.5' power cord to install into the wall j-box.

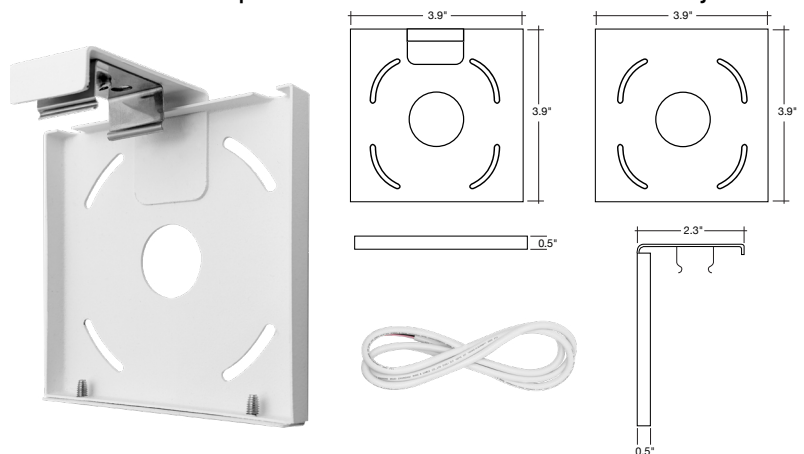

| MODEL # | FINISH ¹ |
|---------|--|
| ALIN-WM | WH White CUSTOM Custom Color View our RAL Chart |

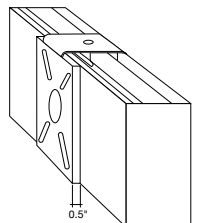



Recessed Drywall Flange Kit (Factory Install Only)

Drywall recessed flange kit must be installed at the factory level. Bracket will allow for recessed and flush installation into drywall or other hard ceiling applications. Specify on your order:

- RTK:** Trim will be installed to all 4 corners of the fixture. Ideal for stand-alone fixtures.
- RTK2:** Trim will be installed to the 2 long (length) sides of the fixture. Ideal for middle fixtures in a continuous run.
- RTK3:** Trim will be installed to the 2 long (length) and 1 short (width) of the fixture. Ideal for the start or end of a continuous run. Recessed bracket will be included with each fixture.

This will not work in T-bar applications. For T-bar applications, use: LED-ALIN2-TB models (separate spec sheet).

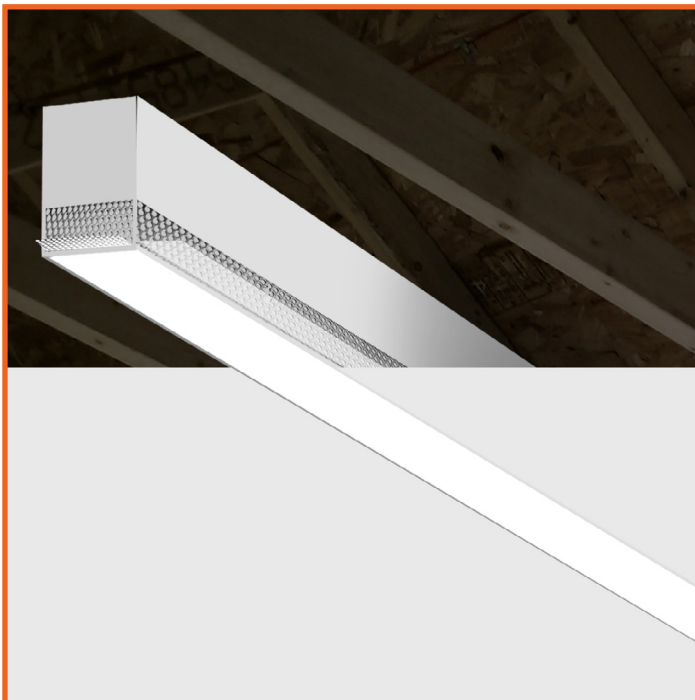
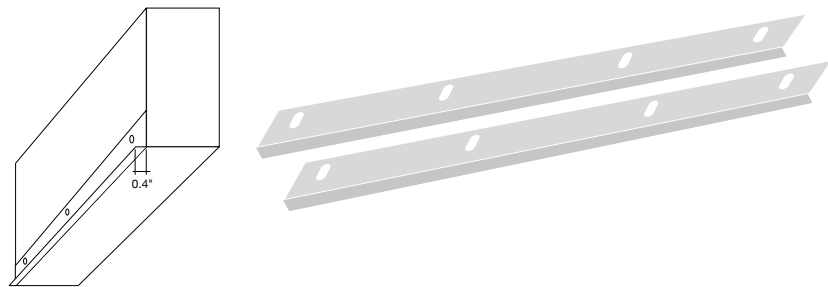

Trimless Recessed Kit (Factory Install Only)

Bracket will allow for trimless/mud-in installation. Bracket will add a 1/16" spacing from the lens to allow room for the mud in.

- TML:** Trim will be installed to all 4 corners of the fixture. Ideal for stand-alone fixtures
- TML2:** Trim will be installed to the 2 long (length) sides of the fixture. Ideal for middle fixtures in a continuous run.
- TML3:** Trim will be installed to the 2 long (length) and 1 short (width) of the fixture. Ideal for the start or end of a continuous run.

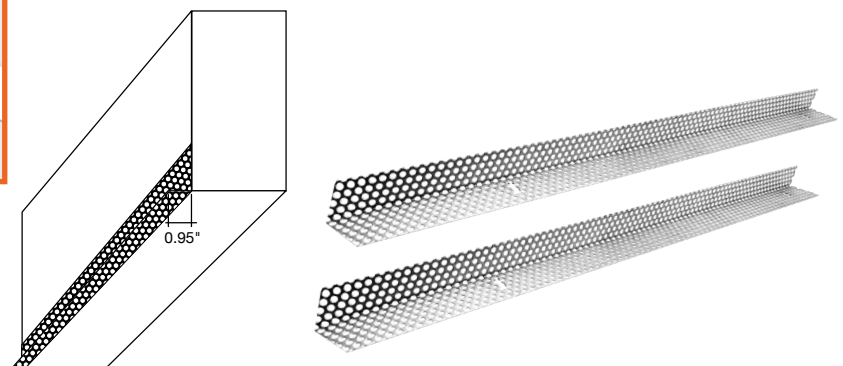

RECESSED TRIMLESS

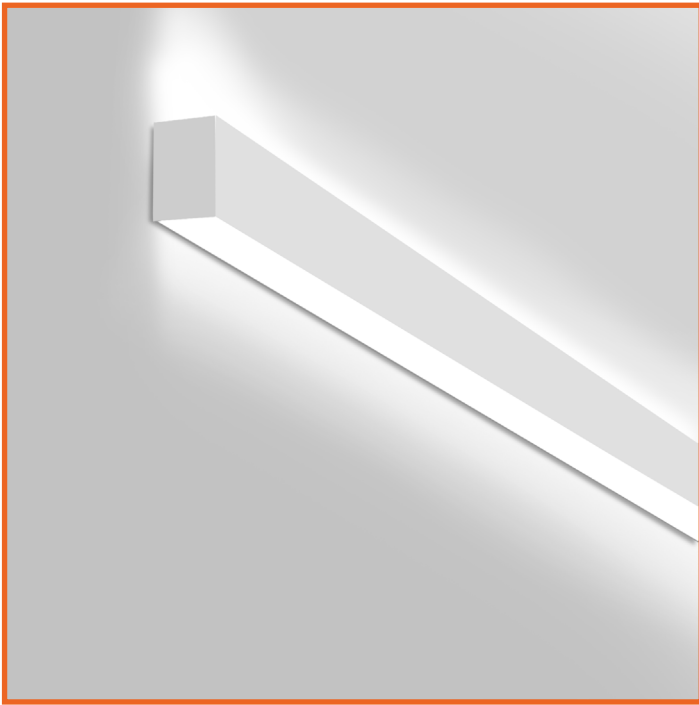

Up Light Kit

Model #'s: ALIN2-2FT-UL, ALIN2-4FT-UL

This option can be field installed but is recommended to be factory installed. Up light is only available on fixtures 2' + length. Ordering guide for field install or stock check:

| MODEL # | UP LIGHT MODEL # |
|------------------------|--|
| LED-ALIN2-2FT-3P25 | Qty 1: ALIN2-2FT-UL |
| LED-ALIN2-4FT-3P50 | Qty 1: ALIN2-4FT-UL |
| LED-ALIN2-6FT-3P75 | Qty 1: ALIN2-2FT-UL Qty 1: ALIN2-4FT-UL |
| LED-ALIN2-8FT-3P100 | Qty 2: ALIN2-4FT-UL |
| LED-ALIN2-24X24-L-3P50 | Qty 2: ALIN2-2FT-UL |
| LED-ALIN2-22X10-T-3P36 | Qty 2: ALIN2-2FT-UL |
| LED-ALIN2-22X22-X-3P50 | Qty 2: ALIN2-2FT-UL |

Arcy-Line: Architectural Linear Fixtures

5-CCT & 3-Power Selectable

DIMENSIONS

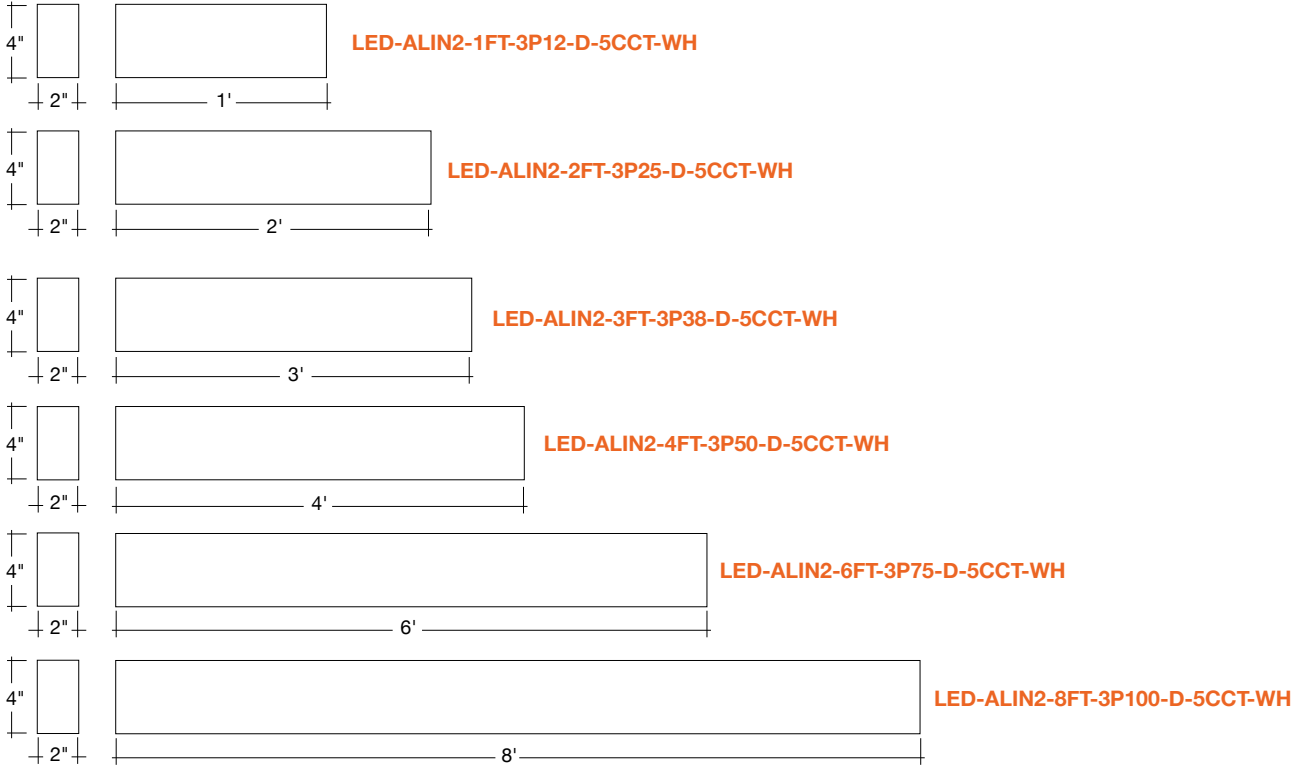

DIMENSIONS

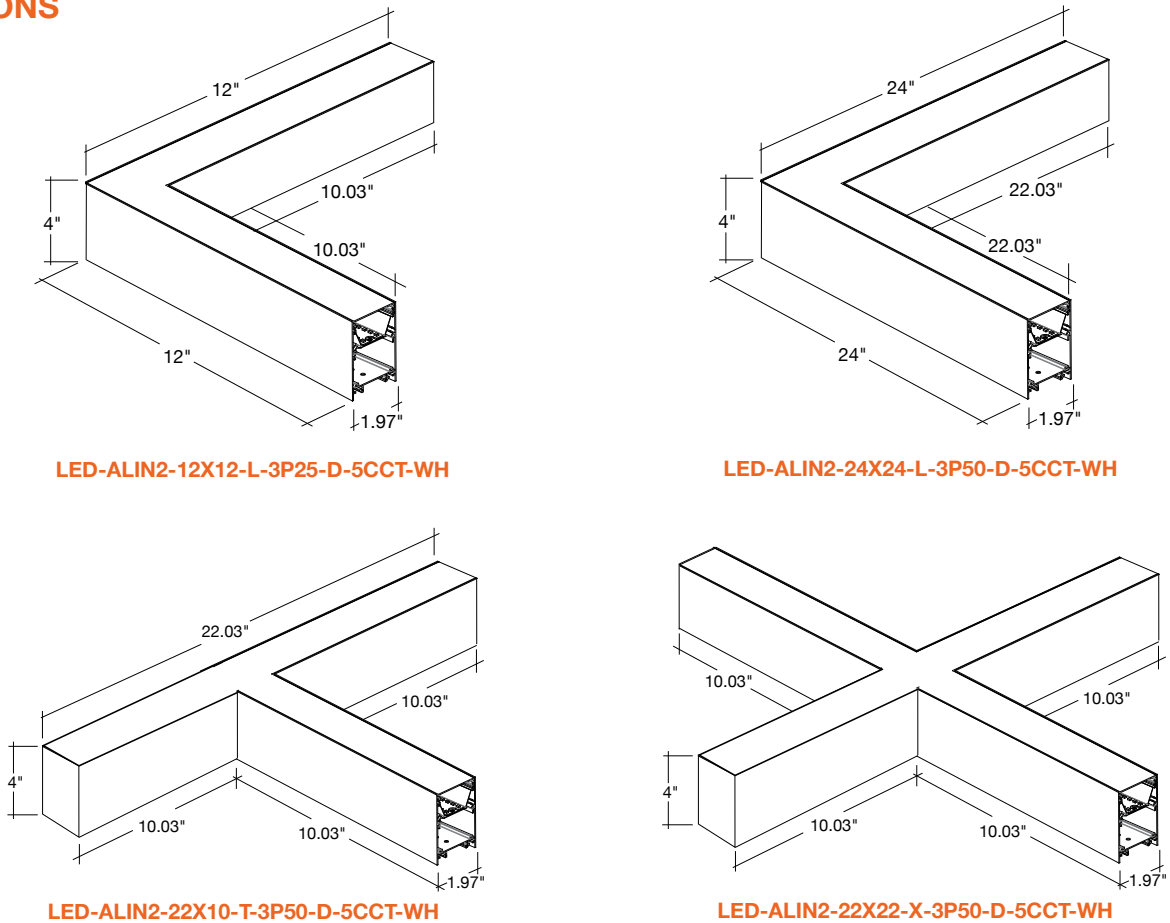

Arcy-Line: Architectural Linear Fixtures

5-CCT & 3-Power Selectable

DIMENSIONS

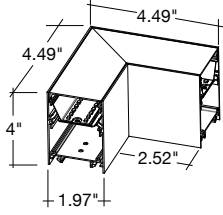

LED-ALIN2-L-D-5CCT-WH

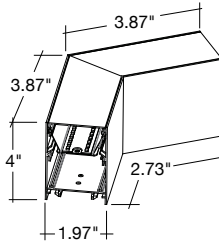

LED-ALIN2-120L-D-5CCT-WH

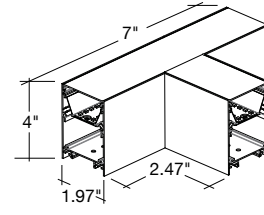

LED-ALIN2-T-D-5CCT-WH

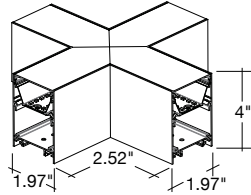

LED-ALIN2-X-D-5CCT-WH

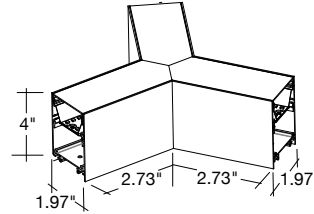

LED-ALIN2-Y-D-5CCT-WH

2X2

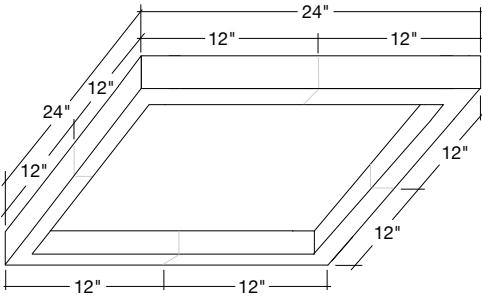

| 2' X 2' SQUARE | QTY. |
|----------------------------------|------|
| LED-ALIN2-12X12-L-3P25-D-5CCT-WH | 4 |

3X3

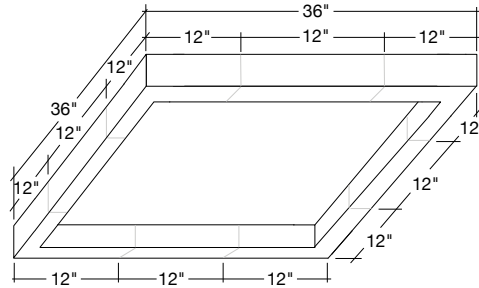

| 3' X 3' SQUARE | QTY. |
|----------------------------------|------|
| LED-ALIN2-12X12-L-3P25-D-5CCT-WH | 4 |
| LED-ALIN2-12-I-3P12.5-D-5CCT-WH | 4 |

4X4

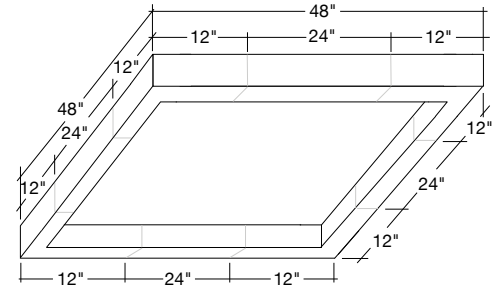

| 4' X 4' SQUARE | QTY. |
|----------------------------------|------|
| LED-ALIN2-12X12-L-3P25-D-5CCT-WH | 4 |
| LED-ALIN2-24-I-3P25-D-5CCT-WH | 4 |

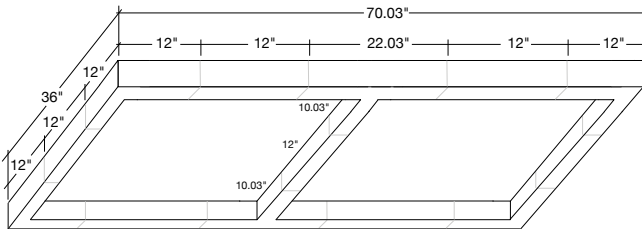

| 3' X 3' (2) SQUARE | QTY. |
|----------------------------------|------|
| LED-ALIN2-12X12-L-3P25-D-5CCT-WH | 4 |
| LED-ALIN2-12-I-3P12.5-D-5CCT-WH | 6 |
| LED-ALIN2-22X10-T-3P50-D-5CCT-WH | 2 |

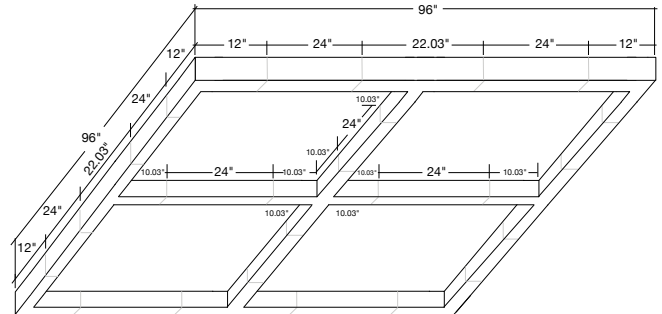

| 3' X 3' (4) SQUARE | QTY. |
|----------------------------------|------|
| LED-ALIN2-12X12-L-3P25-D-5CCT-WH | 4 |
| LED-ALIN2-24-I-3P25-D-5CCT-WH | 10 |
| LED-ALIN2-22X10-T-3P50-D-5CCT-WH | 4 |
| LED-ALIN2-24X24-X-3P50-D-5CCT-WH | 1 |

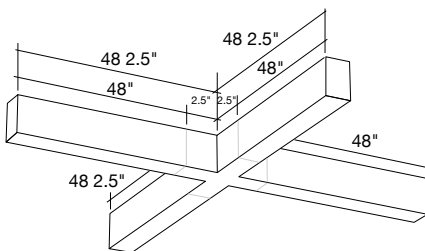

| 8' X 8' (X SHAPE) | QTY. |
|-------------------------------|------|
| LED-ALIN2-48-I-3P50-D-5CCT-WH | 4 |
| LED-ALIN2-X-D-5CCT-WH | 1 |

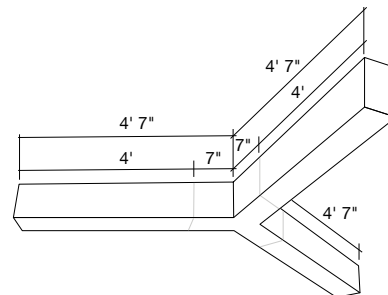

| 4' X 4' X 4' (Y SHAPE) | QTY. |
|-------------------------------|------|
| LED-ALIN2-48-I-3P50-D-5CCT-WH | 3 |
| LED-ALIN2-Y-D-5CCT-WH | 1 |

Arcy-Line: Architectural Linear Fixtures

5-CCT & 3-Power Selectable

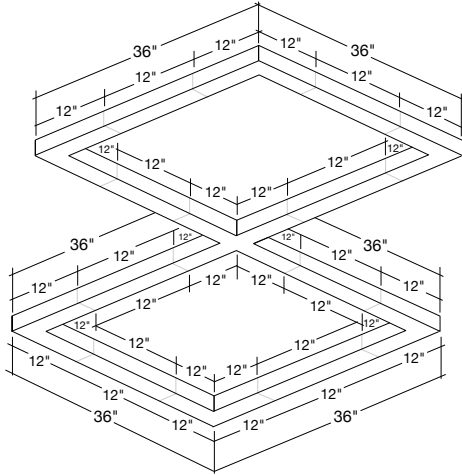

| 3' X 3' (2) SQUARE | QTY. |
|----------------------------------|------|
| LED-ALIN2-12X12-L-3P25-D-5CCT-WH | 6 |
| LED-ALIN2-1FT-3P12-D-5CCT-WH | 8 |
| LED-ALIN2-24X24-X-3P50-D-5CCT-WH | 1 |

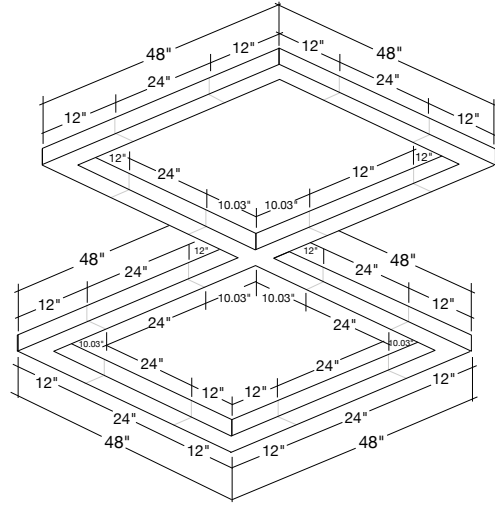

| 4' X 4' (2) SQUARE | QTY. |
|----------------------------------|------|
| LED-ALIN2-12X12-L-3P25-D-5CCT-WH | 6 |
| LED-ALIN2-2FT-3P25-D-5CCT-WH | 8 |
| LED-ALIN2-24X24-X-3P50-D-5CCT-WH | 1 |

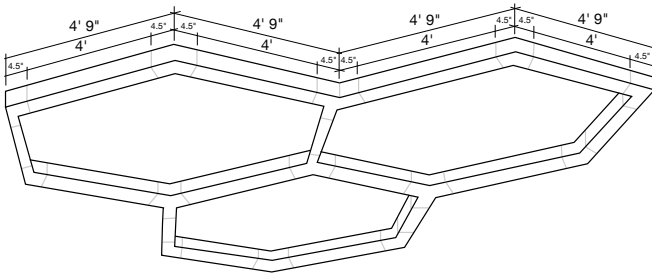

| 3' X 3' (3) TRIPLE HEXAGON | QTY. |
|------------------------------|------|
| LED-ALIN2-120L-D-5CCT-WH | 9 |
| LED-ALIN2-4FT-3P50-D-5CCT-WH | 15 |
| LED-ALIN2-Y-D-5CCT-WH | 4 |

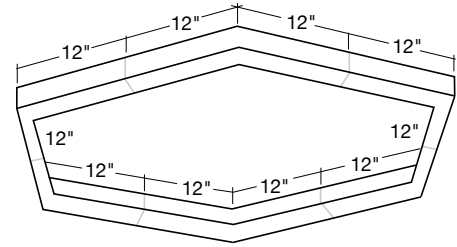

| 2' HEXAGON | QTY. |
|--------------------------------|------|
| LED-ALIN2-12X12-120L-D-5CCT-WH | 6 |

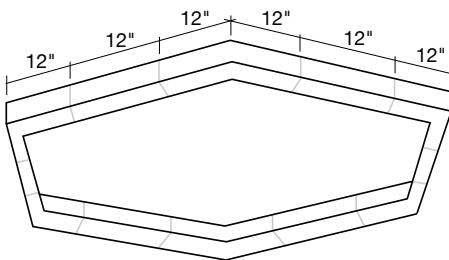

| 3' HEXAGON | QTY. |
|--------------------------------|------|
| LED-ALIN2-12X12-120L-D-5CCT-WH | 6 |
| LED-ALIN2-1FT-3P12-D-5CCT-WH | 6 |

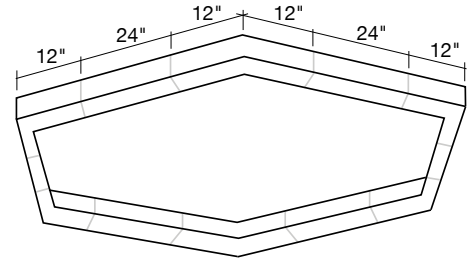

| 4' HEXAGON | QTY. |
|--------------------------------|------|
| LED-ALIN2-12X12-120L-D-5CCT-WH | 6 |
| LED-ALIN2-2FT-3P25-D-5CCT-WH | 6 |

Arcy-Line: Architectural Linear Fixtures

5-CCT & 3-Power Selectable

Powder Coat Colors & Finishes: All fixtures are painted standard white RAL#9003. The below paint RAL# are available for an additional cost per fixture without additional set up fees. Custom RAL# not listed below are available but may require an additional set up fee.

GLOSS OPTIONS

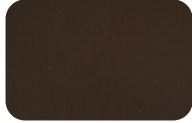

Statuary Bronze 60 Gloss
T026-BR340
Order Code: GL-BZ-1

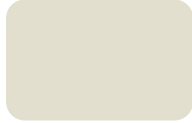

RAL 7042 Grey 80 Gloss
T009-GR230
Order Code: GL-GY-1



Silver Metallic 30 Gloss
T353-GR06
Order Code: GL-SL-1



Chrome Metallic 80 Gloss
T358-GR539
Order Code: GL-CH-1



Brass Metallic 30 Gloss
T353-YL02
Order Code: GL-BM-1



Dark Red 90 Gloss
P009-RD02
Order Code: GL-RD-1



Red 90 Gloss
T009-RD01
Order Code: GL-RD-2



Dark Yellow 90 Gloss
T009-YL71
Order Code: GL-YL-1



Yellow 90 Gloss
T009-YL01
Order Code: GL-YL-2



Terra Brown 90 Gloss
(RAL8028) • C209-BR358
Order Code: GL-BR-1



Traffic Green 70 Gloss
T007-GN16
Order Code: GL-GR-1



DOT Green 70 Gloss
FS14066 • T007-GN13
Order Code: GL-GR-2



Green 60 Gloss
C006-GN03
Order Code: GL-GR-3



Blue 90 Gloss
T009-BL01
Order Code: GL-BL-1



Light Blue 90 Gloss
T009-BL05
Order Code: GL-BU-2



Dark Blue 80 Gloss
T008-BL20
Order Code: GL-BU-3



Designer Beige 90 Gloss
T009-BG16
Order Code: GL-BG-1

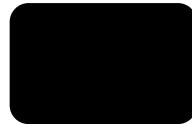

Black 10 Semi-Gloss
T001-BK120
Order Code: SGL-BL-1

HAMMER OPTIONS



Black Hammer
T013-BK62
Order Code: HM-BL-1



Black Hammer Low Gloss
E311-BK04
Order Code: HM-BL-2

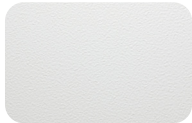

White Hammer
T013-WH09
Order Code: HM-WH-1



Red Hammer
T013-RD15
Order Code: HM-RD-1

HAMMERTONE OPTIONS



Bronze Hammertone
T064-BR24
Order Code: HT-BZ-1



Silver Hammertone
T064-GR05
Order Code: HT-SL-1



Blue Hammertone
T064-BL95
Order Code: HT-BU-1



Green Hammertone
T064-GN81
Order Code: HT-GR-1

VEIN OPTIONS

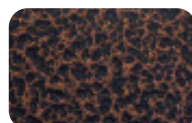

Copper Vein
T375-BK07
Order Code: VN-CP-1



Gold Vein
T375-BK10
Order Code: VN-GD-1



FS 25109 Blue Texture
T032-BL04
Order Code: TX-BU-1

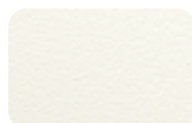

White Texture
T032-WH15
Order Code: TX-WH-1



Oil Rubbed Bronze Texture
T291-BR251
Order Code: TX-BZ-1



Mock Rock Texture
T091-GR309
Order Code: TX-GY-1

TEXTURE OPTIONS