

# LED Flood Light Instructions

## CAUTION:

1. Cannot use the electric generator to test the LED light.
2. Please abide by related country, regional and local law and regulations when install this fixture
3. To avoid electrical shock and damage, please do not install the lights on rainy days.

## NOTICE:

1. To prevent from electrical shock or fire risk, the installation must be conducted by operator who have professional electrical knowledge.
2. Please wear gloves to avoid injury before installing light
3. During or after installation, if there are situations such as smoke, fire in the wires or lights, please turn off the power immediately and notify relevant personnel of an overhaul.
4. This light can be used for outdoor installation.

## INSTRUCTIONS:

1. This product has dimming functions.
2. 2 dimming functions are available in this LED light.
  - A. Constant current can be achieved by 0-10VDC dimming.
  - B. Variation of resistance unit dimming (Please choose the appropriate dimming way according to your needs. You can also choose not to use this function).
3. Choose the wire connection ways, dimming ways and installation ways according to your needs and the LED fixture purchased.

## WIRING DIAGRAM

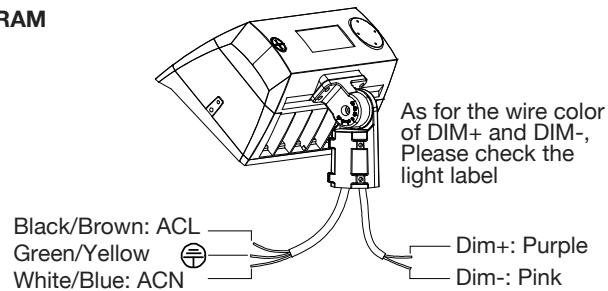

Optional brackets and installation instructions  
 There are 3 optional brackets for this fixture. The following is flood fixtures with different brackets.

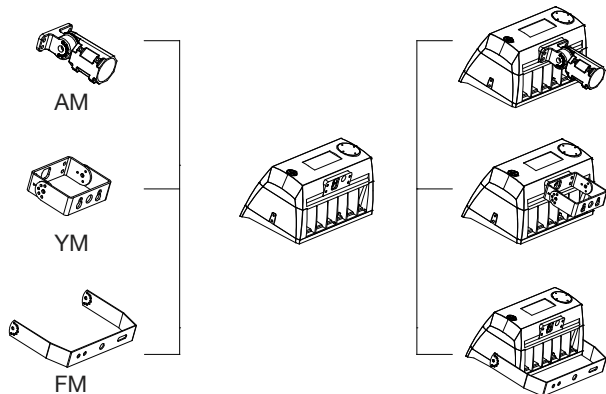

Installation instructions with different brackets:

### 1. Adjustable fitter mounting (AM)

STEP 1: Remove the bracket mounting screws on the fixture and run the wires through the bracket (FIGURE 1)

STEP 2: Install the bracket on the fixture (FIGURE 2)

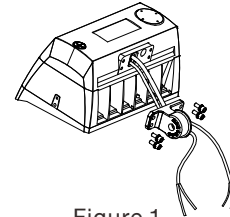

Figure 1

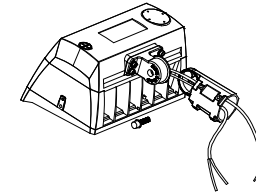
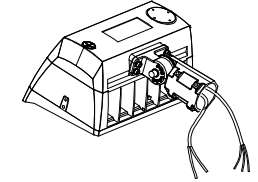

Figure 2



### 2. Yoke Mounting (YM)

STEP 1: Put the input wire of the light across the bracket (FIGURE 3)

STEP 2: Fix the bracket (FIGURE 4)

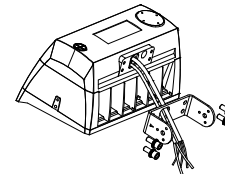

Figure 3

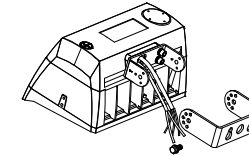
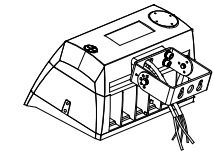

Figure 4



### 3. Flood Mounting (FM)

STEP 1: First install two big screws (FIGURE 5)

STEP 2: Install two small screws (FIGURE 6)

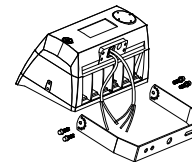

Figure 5

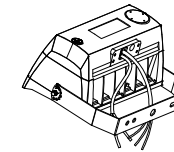

Figure 6

**Installation of LED lights:**

**1. Adjustable fitter mounting (AM)**

STEP 1: Connect the wire correctly and put the wire into pole. Then fasten the locking bolts between slip fitter and the pole. (FIGURE 7)

STEP 2: Loosen the fixing bolts and adjusting bolts, align the fixture to required angle. Tighten adjusting bolt and fixing bolts after the angle is confirmed. (FIGURE 8)

NOTICE: Adjustable angle is 0~±194° (FIGURE 8)

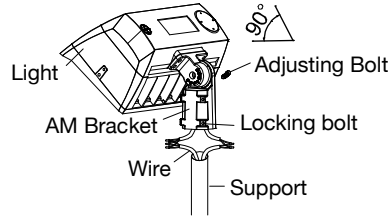

Figure 7

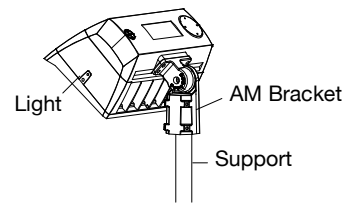

Figure 8

**2. Yoke Mounting (YM)**

STEP 1: Drill holes on the wall as shown. (FIGURE 9)

STEP 2: Knock the expansion bolts into the wall. (FIGURE 10)

STEP 3: Connect the fixture to the bracket and tighten the screws; connect the wires properly (FIGURE 11)

NOTICE: Adjustable angle is 0~±194° (FIGURE 11)

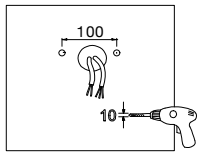

Figure 9

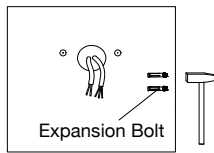

Figure 10

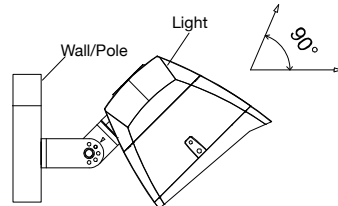

Figure 11

**3. Flood Mounting (FM)**

STEP 1: Drill holes on the wall as shown. (FIGURE 12)

STEP 2: Knock the expansion bolts into the wall. (FIGURE 13)

STEP 3: Connect the fixture to the bracket and tighten the screws; connect the wires properly (FIGURE 14)

NOTICE: Adjustable angle is 0~±194° (FIGURE 14)

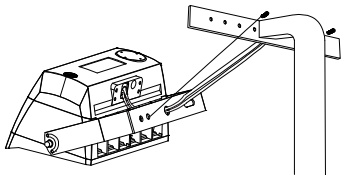

Figure 12

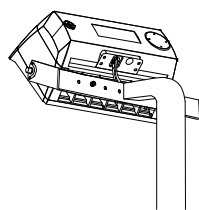

Figure 13

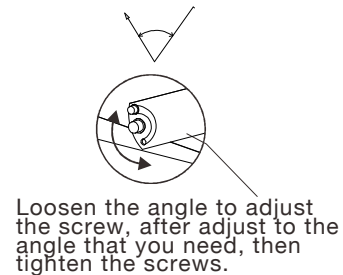

Figure 14

**SPECIAL FUNCTIONS INSTRUCTIONS:**

**1. Instructions for photocell**

When the photocell function is required, photocell should be installed on the back of light;

When it's not required, shorting cap should be installed on the back of light (FIGURE 15)

Open the plastic plug counter clockwise with screwdriver, then slide the switch up and down to adjust the photocell controller in your demand (FIGURE 16)

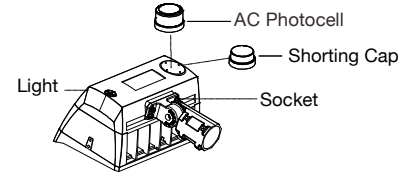

Figure 15

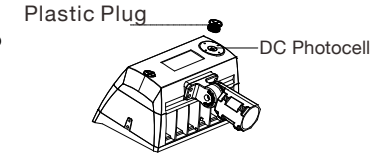

Figure 16

**2. Function adjustment**

STEP 1: Open the metal plug counter clockwise with a screwdriver, then slide the switch up and down to adjust the power controller or CCT controller in your demand (FIGURE 17)

STEP 2: After adjusting the required control function, tighten the metal plug clockwise (FIGURE 18)

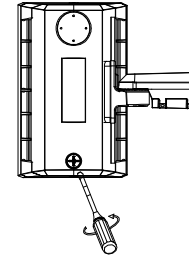

Figure 17

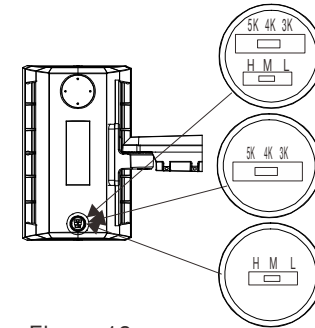

Figure 18

**3. Instructions for motion sensor**

Take the DC microwave sensor out of the package and screw it into the mounting hole (if there is no plug in the mounting hole), or take away the 1/2 plug (FIGURE 19) and screw the DC motion sensor or PIR sensor into the mounting hole. Then adjust the DC microwave to get the function needed by using the remote control (FIGURE 20)

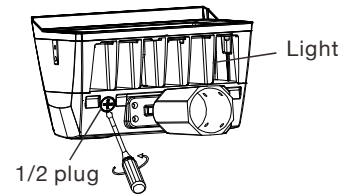

Figure 19

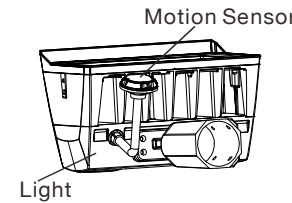

Figure 20

