

LED Dusk to Dawn Light Instructions

CAUTION

1. Do not use the electric generator to test the LED lamp.
2. Please abide by related country, regional or local law and regulations when installing this fixture
3. To avoid electrical shock and damage, do not install light on a rainy day.

NOTICE

1. To prevent electric shock or fire risk, installation must be conducted by operator who have professional electrical knowledge.
2. Please wear gloves to avoid injury before installing light.
3. During or after installation, if there are situations such as smoke, fire in the wires or lamps, turn off the power immediately and notify relevant personnel of an overhaul.
4. This light can be used for outdoor installation.

INSTRUCTIONS

1. This product has dimming function
2. Three dimming functions are available in this light:
 - Constant current can be achieved by 1-10VDC dimming
 - PWM signal dimming
 - Variation of resistance unit dimming (Please choose the appropriate dimming way according to your needs. You can also ochoose not to use this function)
 - Choose the wire connedtion, dimming and installation ways according to your needs and LED fixture purchased.

Wiring Diagram

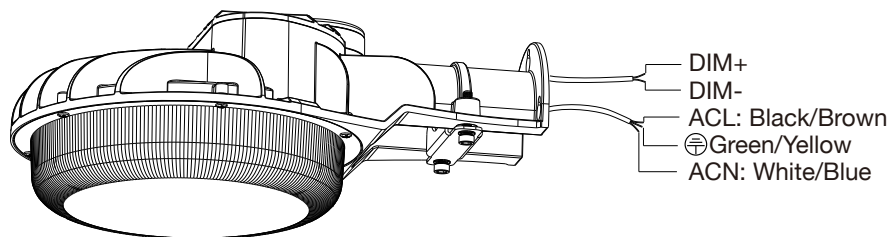

Optional Brackets and Installation Instructions:

There are 2 optional brackets for this fixture. The following is street light fixtures with different brackets.

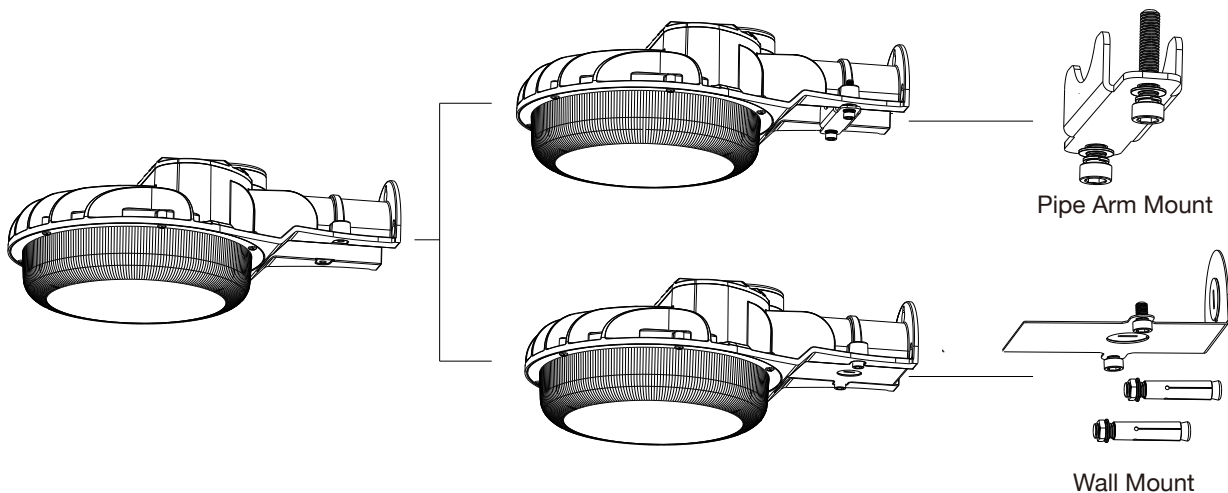

Pipe Arm Installation:

1. Loosen the installation plate on the arm by M6 hex wrench (Figure 1)
2. Connect wires (Figure 2) Put the fixture into the arm.
3. Tighten screws on the installation plate by M6 hex wrench (Figure 3)

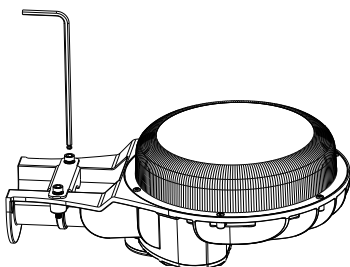

Figure 1

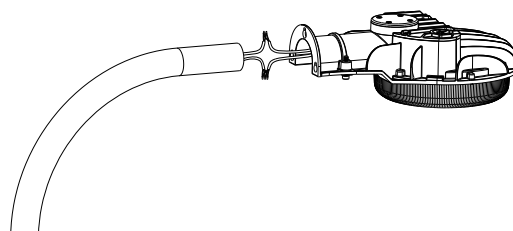

Figure 2

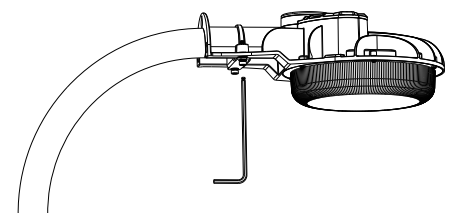

Figure 3

WALL INSTALLATION

1. Drill holes on the wall as shown (Figure 4)
2. Insert expansion screws into the holes by hammer and take off the nut washer (Figure 5)
3. Tear down the wall installation accessories from the lighting fixtures by M6 hex wrench (Figure 6)

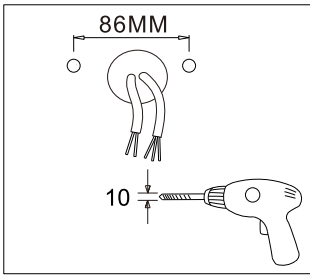

Figure 4

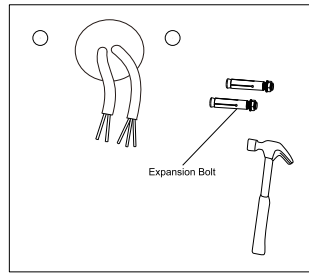

Figure 5

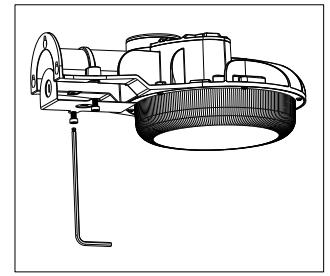

Figure 6

4. Fix the lighting fixture on the wall with studs, tighten up with a wrench
5. Thread the cable to the hole on the cover plate, tighten conduit tube, complete the wiring (Figure 8)
6. Fix the cover plate, fasten the screws (Figure 9)

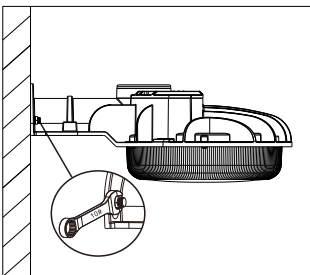

Figure 7

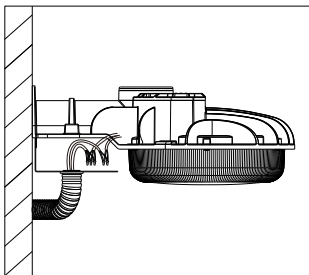

Figure 8

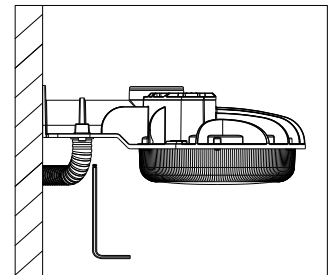

Figure 9

The Photocell Control Explanation

The light with photocell control function, when you need the light control function, install the photocell on the socket; when you do not need the light control function, install the shorting cap on the socket. (Figure 10)

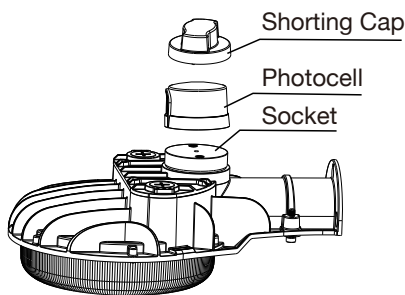

Figure 10

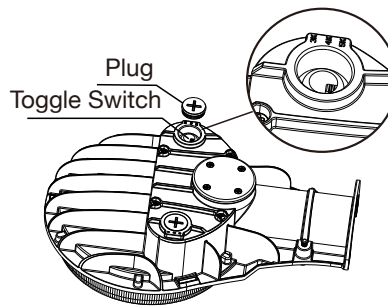

Figure 11

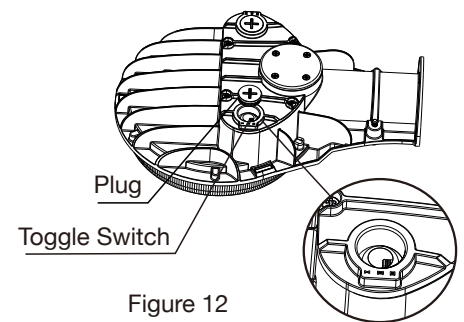

Figure 12

Color Temperature Selection

The light fixture with color temperature adjustable function, tear off the plug on the right, switch it to the tap position you need (Figure 11)

Wattage Selection

The light fixture with watt adjustable function, tear off the plug on the left, switch it to the tap position you need. (Figure 12)

MIN 167°F SUPPLY CONDUCTORS

THIS PRODUCT MUST BE INSTALLED IN ACCORDANCE WITH THE APPLICABLE INSTALLATION CODE BY A PERSON FAMILIAR WITH THE CONSTRUCTION AND OPERATION OF THE PRODUCT AND THE HAZARDS INVOLVED.