

# INSTALLATION INSTRUCTIONS FOR CYLINDERS

## WARNING

READ CAREFULLY BEFORE INSTALLING FIXTURE. RETAIN THESE INSTRUCTIONS FOR FUTURE REFERENCE. The fixtures must be wired in accordance with the National Electrical Code and all applicable local codes. Proper grounding is required for safety. THIS PRODUCT MUST BE INSTALLED IN ACCORDANCE WITH THE APPLICABLE INSTALLATION CODE BY A PERSON FAMILIAR WITH THE CONSTRUCTION AND OPERATION OF THE PRODUCT AND THE HAZARDS INVOLVED.

### WARNING:

- Make certain power is OFF before indoor installing or maintaining fixture. No user serviceable parts inside.
- Fixture is suitable for Damp location.

## FIXTURE

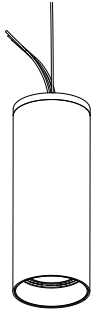

LED-CACM-3-3P15-5CCT-WH-UNV  
LED-CACM-3-3P15-5CCT-BL-UNV

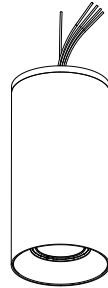

LED-CACM-4-3P15-5CCT-WH-UNV  
LED-CACM-4-3P15-5CCT-BL-UNV  
LED-CACM-4-3P25-5CCT-WH-UNV  
LED-CACM-4-3P25-5CCT-BL-UNV

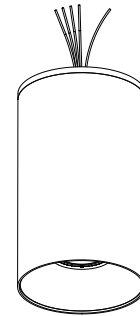

LED-CACM-6-3P25-5CCT-WH-UNV  
LED-CACM-6-3P25-5CCT-BL-UNV  
LED-CACM-6-3P40-5CCT-WH-UNV  
LED-CACM-6-3P40-5CCT-BL-UNV

## DIMENSIONS

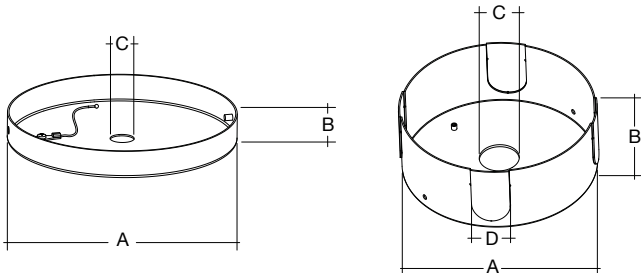

DIMENSIONS	A	B	C	D
Surface Mount Regular Canopy	6"	3/4"	9/16"	—
Pendant Mount Regular Canopy	6"	3/4"	1 3/16"	—
Surface Mount Deep Canopy	6"	2 1/4"	9/16"	1 3/16"
Pendant Mount Deep Canopy	6"	2 1/4"	1 3/16"	1 3/16"

## CCT / POWER / BEAM ANGLE SELECTABLE

Remove the silicone cover and then choose the CCT and power. The fixture is preset to the highest power and 4000k (Fig. 1). (Fig. 1)

Fig. 1

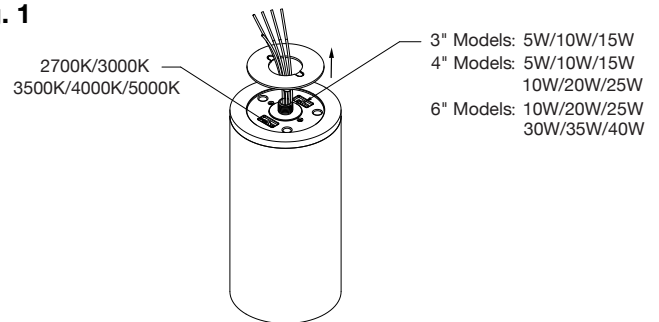

The default beam angle is one the widest option. Open the reflector and you can adjust the beam angle. (Fig. 2)

Fig. 2

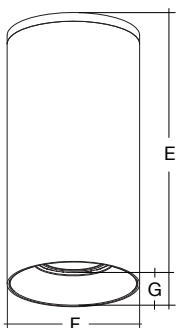
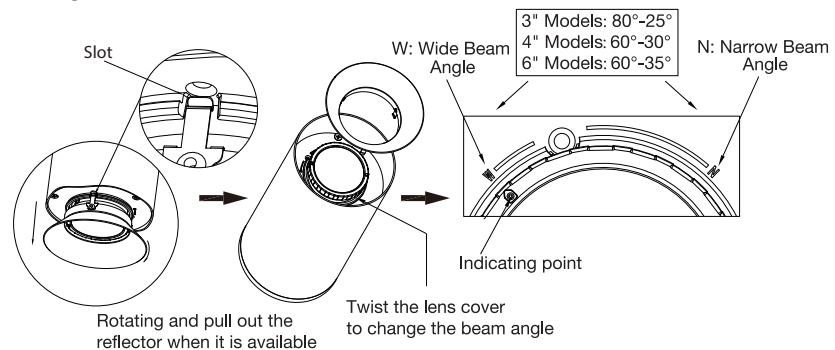

DIMENSIONS	E	F	G
3" Round	8 1/2"	3 1/4"	7/8"
4" Round	9"	4 1/2"	7/8"
6" Round	10"	6"	1 9/16"

# ACCESSORIES

## Surface Mount Regular Canopy Kit

CACM-SH-SM-BL  
CACM-SH-SM-WH

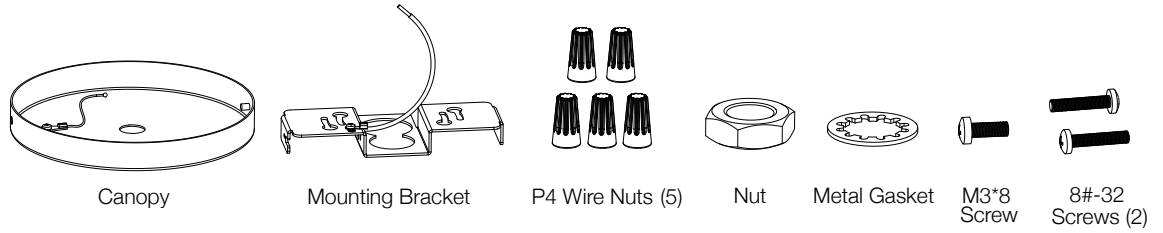

Fig. A

## Surface Mount Deep Canopy Kit

CACM-DP-SM-BL  
CACM-DP-SM-WH

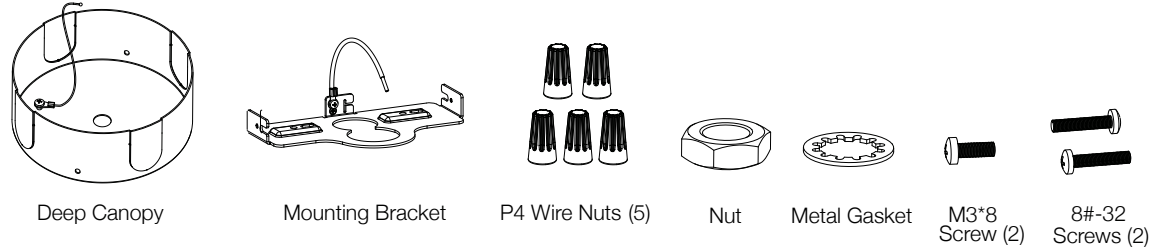

Fig. B

## Pendant Mount Regular Canopy Kit

CACM-SH-PDM-BL  
CACM-SH-PDM-WH

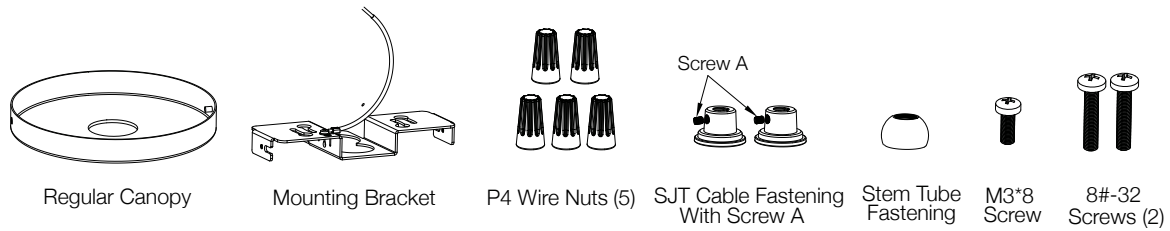

Fig. C

## Pendant Mount Deeper Canopy Kit

CACM-DP-PDM-BL  
CACM-DP-PDM-WH

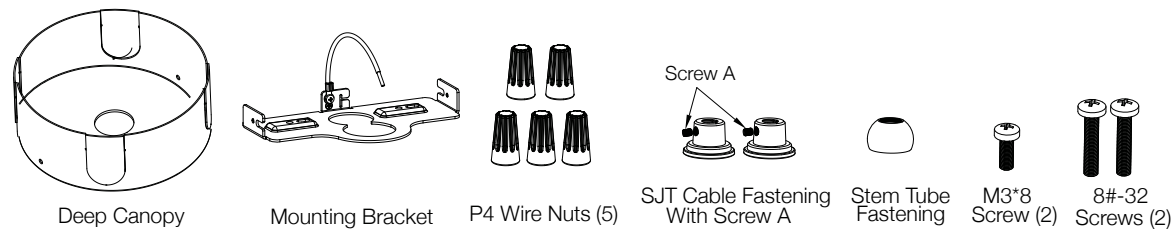
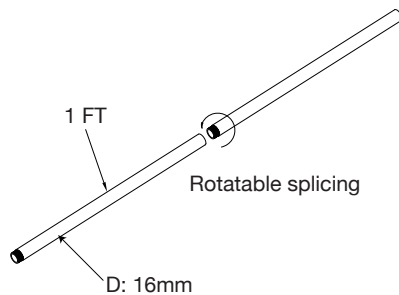

Fig. D

## Pendant Stem

CACM-STM-1FT-BL  
CACM-STM-1FT-WH

Fig. E



## Pendant SJT Cord

SJT-18-5-7FT-BL  
SJT-18-5-7FT-WH  
SJT-18-5-12FT-BL  
SJT-18-5-12FT-WH

Fig. F

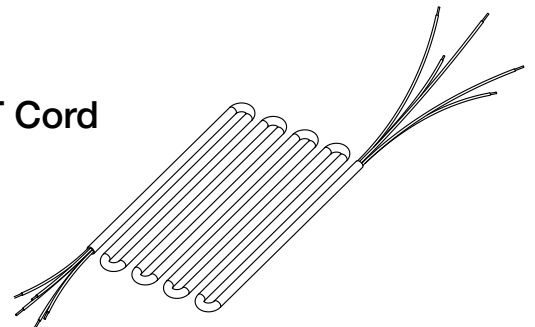

# SURFACE MOUNT INSTALLATION

1. Please choose the right Canopy kit based on the Outlet Box place. See Fig. A/B and Fig. 3  
Notes: The deep canopy kit only can match with 2-1/8" height Outlet Box.

**Fig. 3**

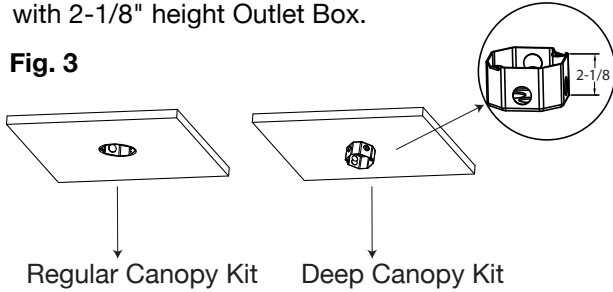

2. Fix the Canopy to the fixtures as Fig.4 showed.

**Fig. 4**

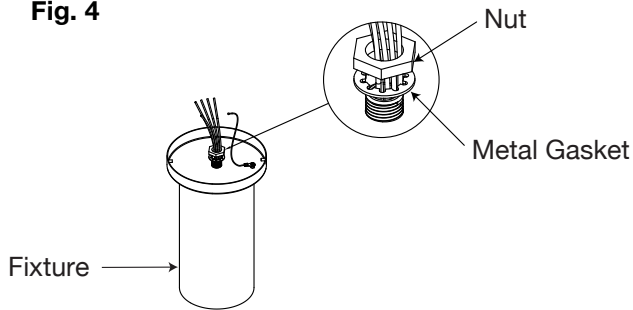

3. Fix the Mounting Bracket to the Outlet Box with 8#-32 Screws (2) as Fig.5 showed.

**Fig. 5**

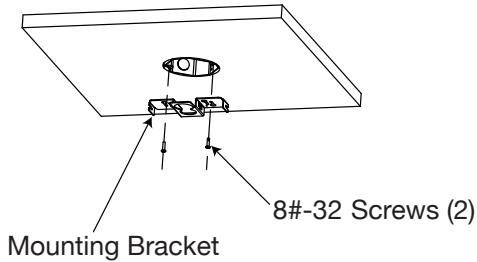

4. Connect Tether Cable on Canopy to Tether Slot in Mounting Bracket as Fig.6 showed.

**Fig. 6**

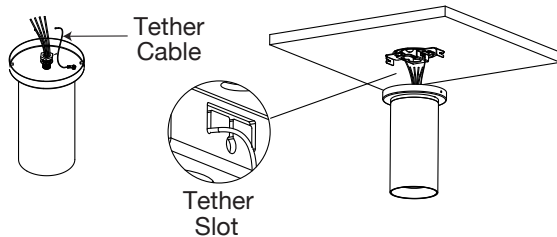

5. Connect the wires with P4 Wire Nuts (5) according to Wiring Diagram (See Fig.24 and Fig.25 and Fig.7 ) white-white,black-black,green-green/ground(violet to 0-10V dimming positive, pink to 0-10V dimming negative,if the fixture is 0-10V version).

**Fig. 7**

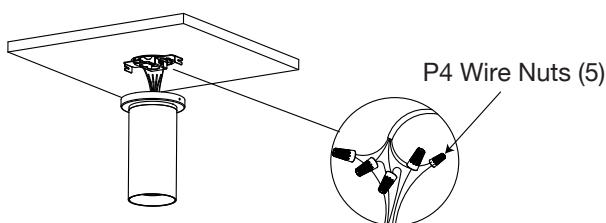

6. Align the holes on Canopy and Mounting Bracket to fix Canopy back to Mounting Bracket counterclockwise and tighten them with Screw.  
For the Surface Outlet Box,tighten them with the screws on both sides as Fig.8 showed.

**Fig. 8**

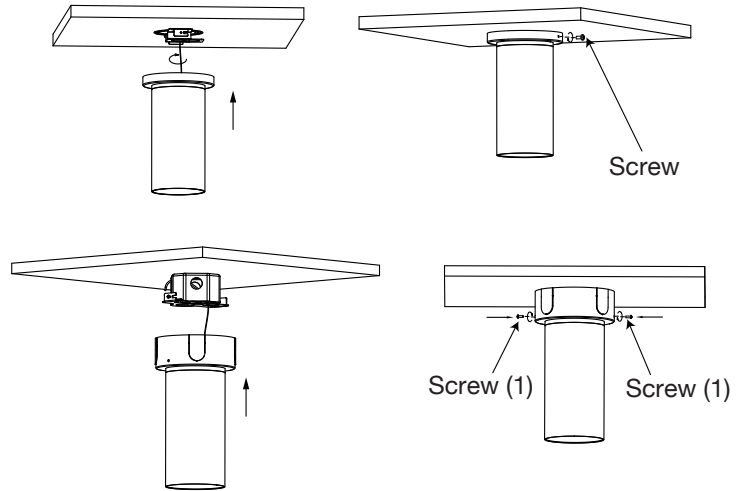

# PENDENT SJT CORD MOUNT

1. Please choose the right Canopy kit based on the Outlet Box place. See Fig. C/D and Fig. F and Fig. 9  
Notes: The deep canopy kit only can match with 2-1/8" height Outlet Box.

**Fig. 9**

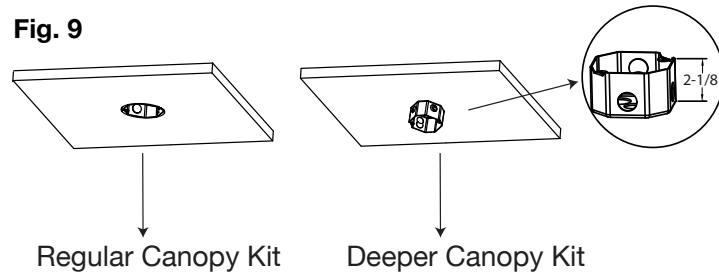

2. Pass Flexible Cord through SJT Cable Fastening and tighten it with Screw A securely as Fig.10 showed.

**Fig. 10**

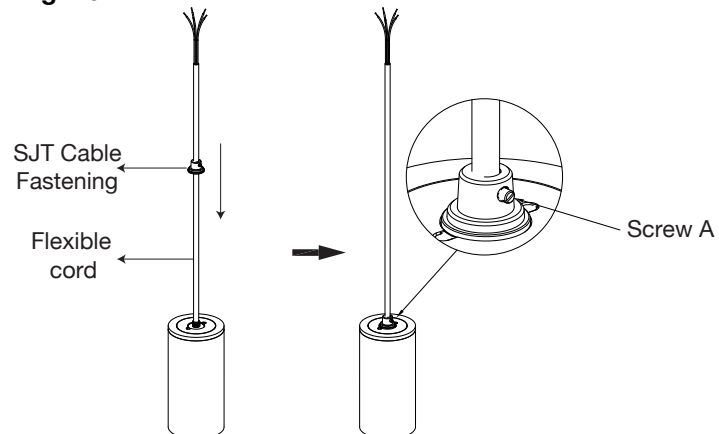

## PENDENT SJT CORD MOUNT (cont'd)

3. Pass Flexible Cord through Canopy and SJT Cable Fastening and tighten Cable Fastening into the top of Flexible Cord with Screw A securely as Fig. 11

**Fig. 11**

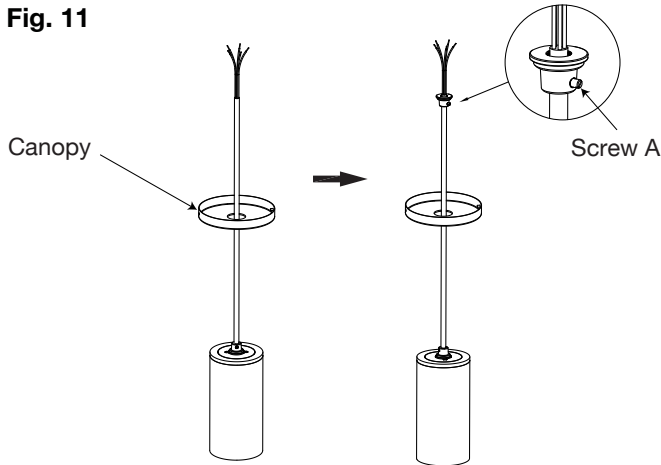

4. Fix the Mounting Bracket to the Outlet Box with 8#-32 Screws (2) as Fig.12 showed.

**Fig. 12**

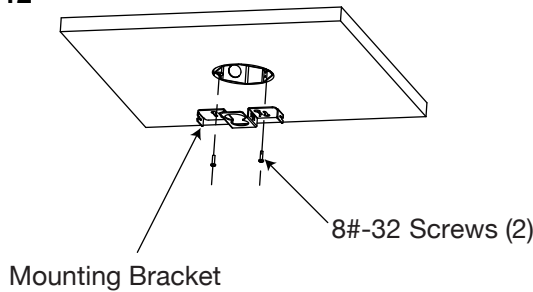

5. Pass SJT Cable Fastening through the large hole on the Mounting Bracket and move it to the small hole, the fixture is fixed as Fig.13 showed.

**Fig. 13**

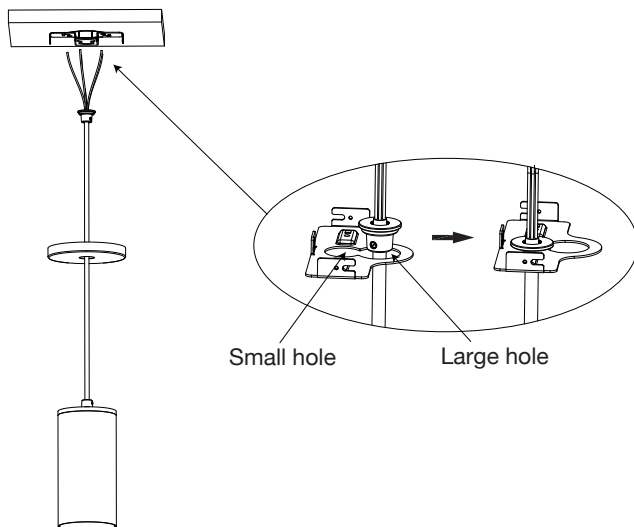

## PENDENT SJT CORD MOUNT (cont'd)

6. Connect the wires with P4 Wire Nuts (5) according to Wiring Diagram (See Fig. 24 and Fig. 25 and Fig. 14) white-white, black-black, green-green/ground (violet to 0-10V dimming positive, pink to 0-10V dimming negative, if the fixture is 0-10V version).

**Fig. 14**

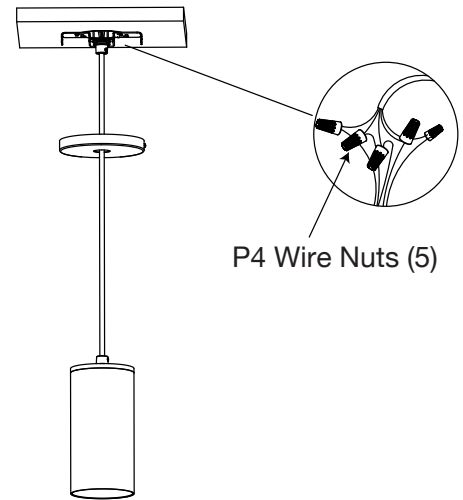

7. Fix Canopy to Junction Box Adaptor Plate and tighten them with Screw A. For the Surface Junction Box, tighten them with screws (2) on both sides as Fig. 15 showed.

**Fig. 15**

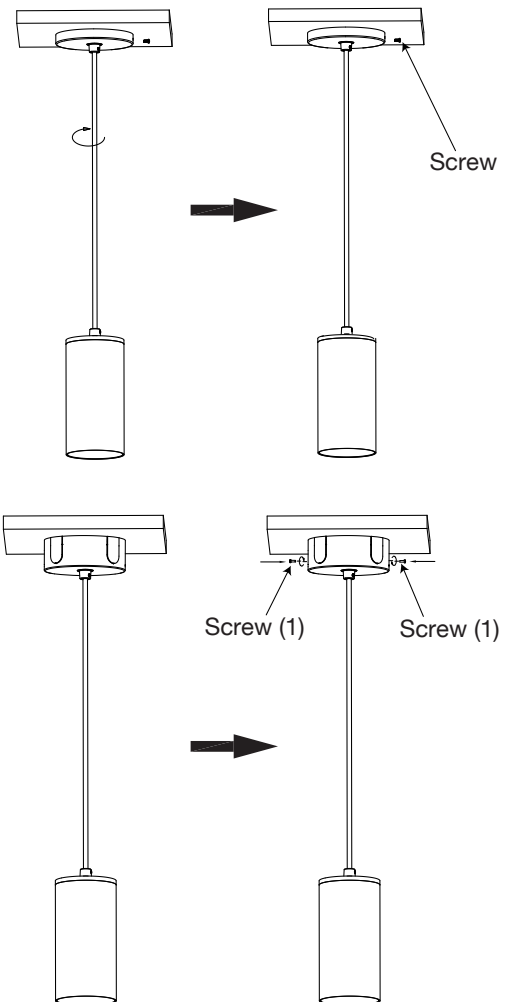

# PENDENT STEM MOUNT

1. Please choose the right Canopy kit based on the Outlet Box place. See Fig. C/D and Fig.E and Fig.16

Notes: The deep canopy kit only can match with 2-1/8" height Outlet Box.

**Fig. 16**

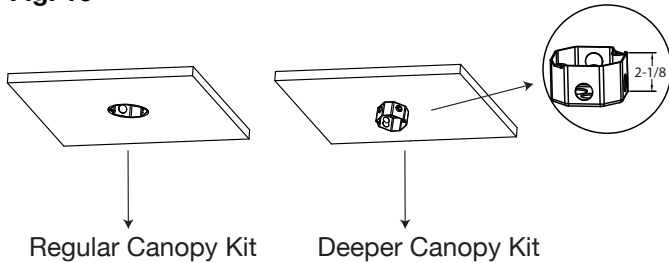

2. Insert Cord through Stem section. Screw Stem section to Fixture as Fig.17 showed.

**Fig. 17**

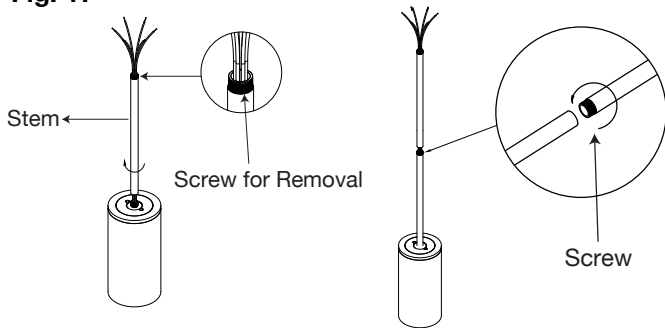

3. Put the Canopy on the fixture as below picture showed, and then fix the round sharp kit the Stem Tube. (Fig. 18)

**Fig. 18**

Rotating to fix round sharp kit

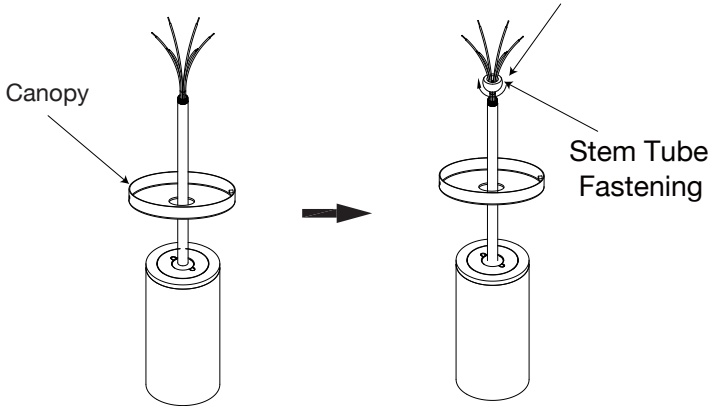

4. Fix the Mounting Bracket to the Outlet Box with 8#-32 Screws (2) as Fig.19 showed.

**Fig. 19**

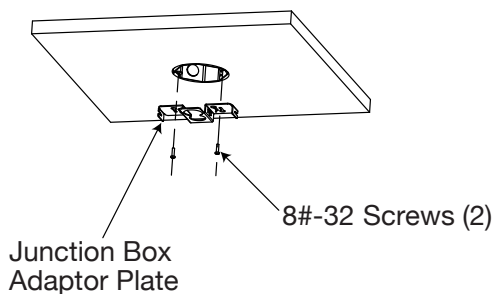

# PENDENT STEM MOUNT (cont'd)

5. Please fix the Stem as Fig.20 showed, Push the kit through the Large hole and move to the Small hole.

**Fig. 20**

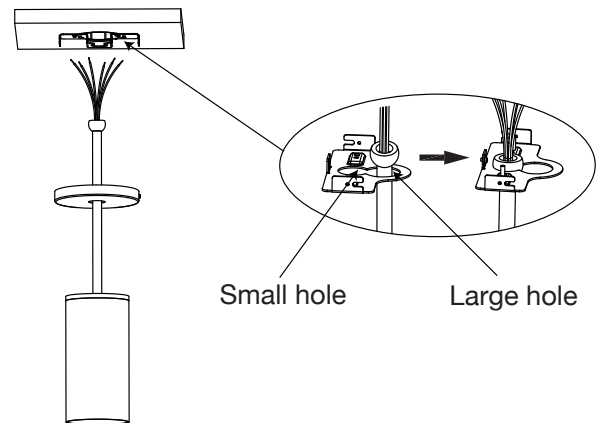

6. Connect wires with P4 Wire Nuts (5) according to wiring Diagram (See Fig. 24 and Fig. 25 and Fig. 21) white-white, black-black, green-green/ground (violet to 0-10V dimming positive, pink to 0-10V dimming negative, if the fixture is 0-10V version).

**Fig. 21**

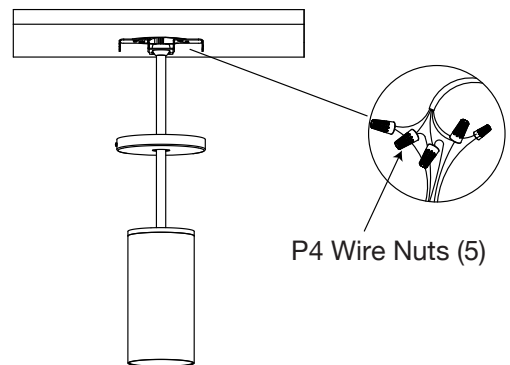

7. Fix Canopy to Junction Box Adaptor Plate and tighten them with Screw A. For the Surface Junction Box, tighten them with screws (2) on both sides as Fig. 22 showed.

**Fig. 22**

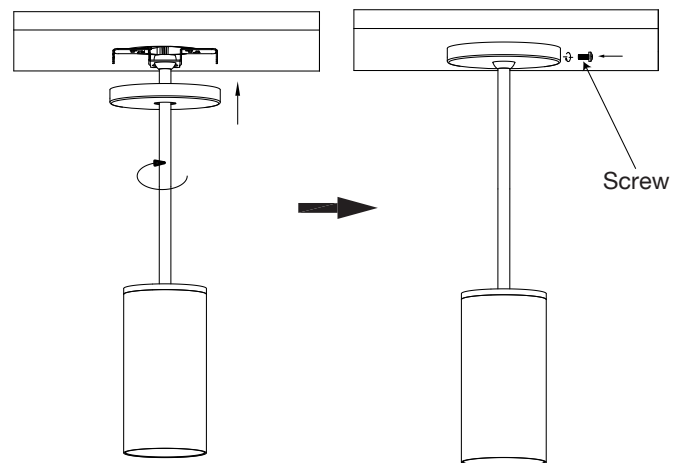

# PENDENT STEM MOUNT (cont'd)

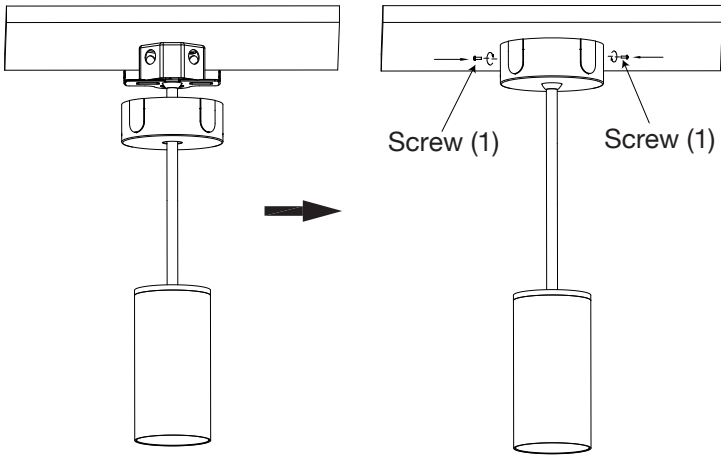

Notes: See Fig. 23

**Fig. 23**

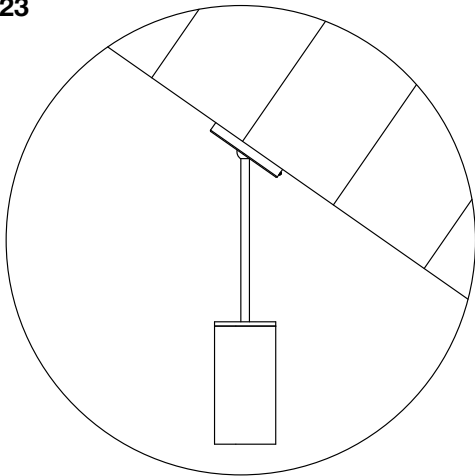

Max.35° Slope

# WIRING DIAGRAM

**Fig. 24**

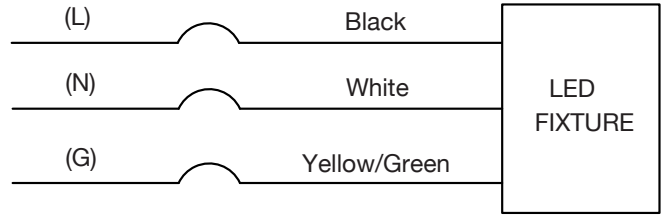

**Fig. 25**

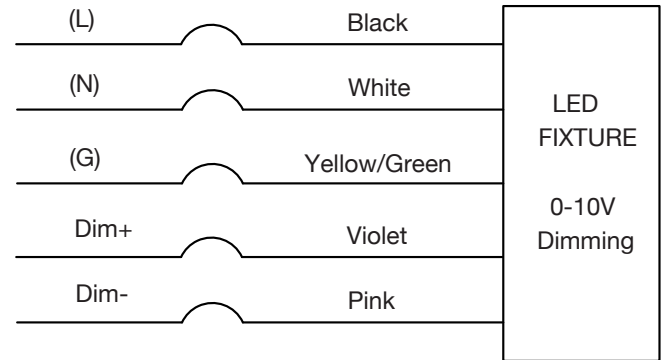

This device complies with Part 15 of the FCC Rules. Operation is subject to the following two conditions:  
 (1) This device may not cause harmful interference  
 (2) This device must accept any interference received, including interference that may cause undesired operation.