

# ARCY-Line: Cylinder Downlights

## CACM Modules



3"



4"

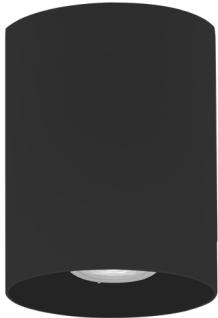

6"



STEM HUNG



CORD HUNG



SURFACE MOUNT

### Detail Specifications:

- Housing Finish: White or Black
- Reflector Finish: White, Black, Clear-Specular Haze
  - Fixture includes same color reflector as housing standard
- Wet Location Rated
- Beam Angle Adjustable:
  - 3": 25-80°
  - 4 & 6": 35-60°
- Chip: COB, R9 >50, CRI >90
- Low UGR <22
- 5-CCT: 27/30/35/40/50k
- 3 Step MacAdam Ellipses
- Operating Temperature: -40° - 114° F
- Lens: Clear PC, non-yellowing
- Average life (L70) of 70,000 hours

### Applications:

- General Recessed Lighting
- General Suspended & Pendant Lighting
- Residential & Multifamily
- Office, Hallways and Meeting Rooms
- Education, Healthcare, Retail, Hospitality
- Commercial Lighting

### Product Information:

- Deep reflector lens reduces glare and optimizes even beam distribution
- Push-in/pull-out reflector: reflector insert and colors can be swapped
- Adjust the beam angle in the field by hand
- Select-n-Switch Technology: 5-CCT + 3-Power Selectable
  - Fixtures are preset to 5000k & max wattage

### Driver Options:

- Voltage: UNV: 120-277V
- Tri-Mode Dimming: 0-10V, ELV, Triac
- Class II isolated, Flicker Free
- THD: <20% (+/-5% tolerance), PF >0.9, 50/60Hz
- Built in 2.5Kv Surge Protector

### Mounting & Installation:

- Surface mount into 30 or 40 J-box
  - 0.75" height option available for recessed j-box
  - 2.3" height option available for surface mount j-box, pipe, emb
- Suspend with cord or cord + stem
- Can be removed from below the ceiling for service or replacement

### Certifications:

- ETL Listed for USA and CA
- Energy Star Certified
- CA Title 24 JA8-2022, CEC T20 Listed
- 5 Year Limited Warranty
- FCC CFR 47, GCC Part 15, Subpart B:2017
- IC Rated
- ASTM-E283 Air-Tight

# ORDERING GUIDE

Series <sup>1</sup>	Finish <sup>2</sup>	Voltage	SJT Cord <sup>3</sup>
<b>LED-CACM-3-3P15-5CCT</b> 3" Module	<b>WH</b> White	<b>- UNV -</b> 120	<b>(blank)</b> No SJT cord
<b>LED-CACM-4-3P15-5CCT</b> 4" Module	<b>BL</b> Black	-277V	(select this for surface mount)
<b>LED-CACM-4-3P25-5CCT</b> 4" Module	<b>BZ<sup>2</sup></b> Bronze		<b>7FT</b> 7' SJT
<b>LED-CACM-6-3P25-5CCT</b> 6" Module	<b>GRY<sup>2</sup></b> Gray		installed to fixture
<b>LED-CACM-6-3P40-5CCT</b> 6" Module	<b>SLV<sup>2</sup></b> Silver		<b>12FT</b> 12' SJT
	<b>CS<sup>2</sup></b> Custom Color		installed to fixture

Notes: Mounting hardware is not included with module.

Notes: White and black standard quick ship finish. Other finishes are made to order locally.

Select SJT 5-wire cord installed into fixture for cord or stem mounting. SJT is field cuttable to size. SJT is also available for field install.

3P15		3P25		3P40	
WATT	LUMENS	WATT	LUMENS	WATT	LUMENS
15	1,400	25	2,500	40	4,000
10	950	20	2,000	35	3,500
5	500	10	1,000	30	3,000

## SURFACE MOUNT OPTIONS

Surface Mount Canopy 0.75" Height for recessed 30/40 j-box	Surface Mount Deep Canopy 2.3" Height for J-box/ Pipe/ Empty EMB Matching Body	Surface Mount EMB Deep Canopy 2.3" Height with EMB installed
<b>CACM-SH-SM-WH</b> White	<b>CACM-DP-SM-WH</b> White	<b>CACM-DP-SM-WH-EMB</b> White
<b>CACM-SH-SM-BL</b> Black	<b>CACM-DP-SM-BL</b> Black	<b>CACM-DP-SM-BL-EMB</b> Black
<b>CACM-SH-SM-BZ<sup>1</sup></b> Bronze	<b>CACM-DP-SM-BZ<sup>1</sup></b> Bronze	<b>CACM-DP-SM-BZ-EMB<sup>1</sup></b> Bronze
<b>CACM-SH-SM-GRY<sup>1</sup></b> Gray	<b>CACM-DP-SM-GRY<sup>1</sup></b> Gray	<b>CACM-DP-SM-GRY-EMB<sup>1</sup></b> Gray
<b>CACM-SH-SM-SLV<sup>1</sup></b> Silver	<b>CACM-DP-SM-SLV<sup>1</sup></b> Silver	<b>CACM-DP-SM-SLV-EMB<sup>1</sup></b> Silver
<b>CACM-SH-SM-CS<sup>1</sup></b> Custom Finish	<b>CACM-DP-SM-CS<sup>1</sup></b> Custom Finish	<b>CACM-DP-SM-CS-EMB<sup>1</sup></b> Custom Finish

## PENDANT MOUNT CANOPY OPTIONS (Must Purchase Cord)

Pendant Mount Canopy 0.75" Height for recessed 30/40 j-box	Pendant Mount Deep Canopy 2.3" Height for J-box / Pipe Empty EMB Matching Body	Pendant Mount EMB Deep Canopy 2.3" Height with EMB
<b>CACM-SH-PDM-WH</b> White	<b>CACM-DP-PDM-WH</b> White	<b>CACM-DP-PDM-WH-EMB</b> White
<b>CACM-SH-PDM-BL</b> Black	<b>CACM-DP-PDM-BL</b> Black	<b>CACM-DP-PDM-BL-EMB</b> Black
<b>CACM-SH-PDM-BZ<sup>1</sup></b> Bronze	<b>CACM-DP-PDM-BZ<sup>1</sup></b> Bronze	<b>CACM-DP-PDM-BZ-EMB<sup>1</sup></b> Bronze
<b>CACM-SH-PDM-GRY<sup>1</sup></b> Gray	<b>CACM-DP-PDM-GRY<sup>1</sup></b> Gray	<b>CACM-DP-PDM-GRY-EMB<sup>1</sup></b> Gray
<b>CACM-SH-PDM-SLV<sup>1</sup></b> Silver	<b>CACM-DP-PDM-SLV<sup>1</sup></b> Silver	<b>CACM-DP-PDM-SLV-EMB<sup>1</sup></b> Silver
<b>CACM-SH-PDM-CS<sup>1</sup></b> Custom Finish	<b>CACM-DP-PDM-CS<sup>1</sup></b> Custom Finish	<b>CACM-DP-PDM-CS-EMB<sup>1</sup></b> Custom Finish

## PENDANT MOUNT SJT CORD OPTION (Must Purchase Cord with Pendant Mount Canopy)    PENDANT MOUNT STEM OPTION (Power Cord Is Not Included)

White Cords	Black Cords
<b>SJT-18-5-7FT-WH</b> 7' Cord	<b>SJT-18-5-7FT-BL</b> 7' Cord
<b>SJT-18-5-12FT-WH</b> 12' Cord	<b>SJT-18-5-12FT-BL</b> 12' Cord

- Cord must be purchased in all pendant application. Cord is not included with stems.
- 5-Wire- White: Hot, Black: Neutral, Green: Ground, Purple/Gray: 0-10V Dimming wire. Do not connect in triac/elv applications and cap off.
- 6-wire is not needed in emergency options. Emergency backup location is inside of the canopy. Bring 24 hour power for EMB into the canopy only.
- Do not hang fixtures by more 11 feet by cord.
- Cords include quick connect for easy field installation. Cords may be factory ordered pre-installed to the fixture.

Cords
<b>CACM-STM-1FT-WH</b> White
<b>CACM-STM-1FT-BL</b> Black
<b>CACM-STM-1FT-BZ<sup>1</sup></b> Bronze
<b>CACM-STM-1FT-GRY<sup>1</sup></b> Gray
<b>CACM-STM-1FT-SLV<sup>1</sup></b> Silver
<b>CACM-STM-1FT-CS<sup>1</sup></b> Custom Finish

- Connect up to 11 stems together

**Footnote:**  
1. Field installable. Lasts 90 minutes.

### TESTED COMPATIBLE DIMMERS

Other dimmers may be compatible but have not been tested. Please contact us for more information.

LEVITON	IP710-DLZ
SYNERGY	ISD BC 120/277 WH
EATON	SF10P-W
LUTRON	DVSTV-WH
HUBBELL	PSD710
HUBBELL	RSD710Z

# ARCY-Line: Cylinder Downlights

## CACM Modules

### FEATURES



### DIMENSIONS

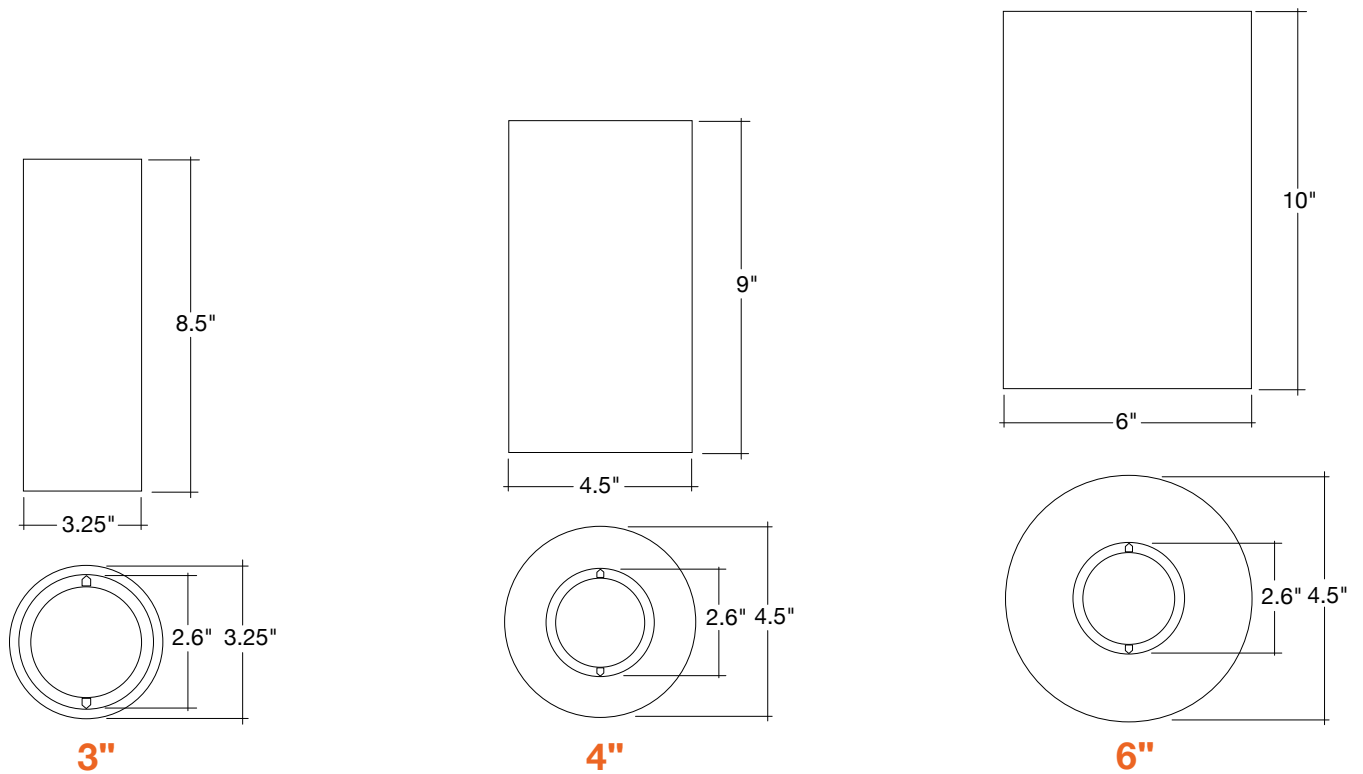

Specs and model numbers are subject to change with or without notice. Customization of product is available.

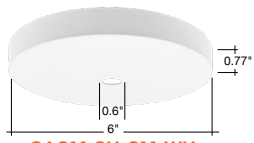

CACM-SH-SM-WH



CACM-SH-SM-BL

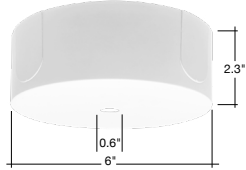

CACM-DP-SM-WH



CACM-DP-SM-BL

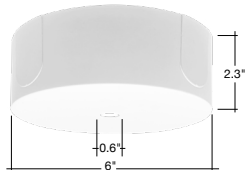

CACM-DP-SM-WH-EMB



CACM-DP-SM-BL-EMB

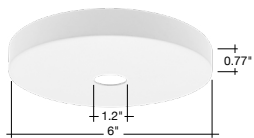

CACM-SH-PDM-WH



CACM-SH-PDM-BL

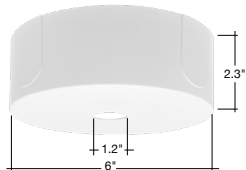

CACM-DP-PDM-WH



CACM-DP-PDM-BL

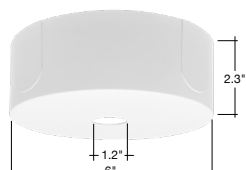

CACM-DP-PDM-WH-EMB



CACM-DP-PDM-BL-EMB



SJT-18-5-7FT-WH  
SJT-18-5-12FT-WH



SJT-18-5-7FT-BL  
SJT-18-5-12FT-BL



CACM-STM-1FT-WH



CACM-STM-1FT-BL

Model	Voltage	Watts	Lumens	Color	CRI
LED-CACM-3-3P15-5CCT-WH-UNV	120-277V	15/10/5w	1,400/950/500	27/30/35/40/50K	>90
LED-CACM-3-3P15-5CCT-BL-UNV	120-277V	15/10/5w	1,400/950/500	27/30/35/40/50K	>90
LED-CACM-4-3P15-5CCT-WH-UNV	120-277V	15/10/5w	1,400/950/500	27/30/35/40/50K	>90
LED-CACM-4-3P15-5CCT-BL-UNV	120-277V	15/10/5w	1,400/950/500	27/30/35/40/50K	>90
LED-CACM-4-3P25-5CCT-WH-UNV	120-277V	25/20/10	2,500/2,000/1,000	27/30/35/40/50K	>90
LED-CACM-4-3P25-5CCT-BL-UNV	120-277V	25/20/10	2,500/2,000/1,000	27/30/35/40/50K	>90
LED-CACM-6-3P25-5CCT-WH-UNV	120-277V	25/20/10	2,500/2,000/1,000	27/30/35/40/50K	>90
LED-CACM-6-3P25-5CCT-BL-UNV	120-277V	25/20/10	2,500/2,000/1,000	27/30/35/40/50K	>90
LED-CACM-6-3P40-5CCT-WH-UNV	120-277V	40/35/30w	4,000/3,500/3,000	27/30/35/40/50K	>90
LED-CACM-6-3P40-5CCT-BL-UNV	120-277V	40/35/30w	4,000/3,500/3,000	27/30/35/40/50K	>90

## SURFACE MOUNT CANOPY

Model	Description
CACM-SH-SM-WH	Surface Mount Canopy 0.75" Height
CACM-SH-SM-BL	Surface Mount Canopy 0.75" Height

## SURFACE MOUNT DEEP CANOPY

Model	Description
CACM-DP-SM-WH	Surface Mount Canopy 2.3" Height for J-box/ Pipe
CACM-DP-SM-BL	Surface Mount Canopy 2.3" Height for J-box/ Pipe

## SURFACE MOUNT EMB DEEP CANOPY

Model	Description
CACM-DP-SM-WH-EMB	Surface Mount Canopy 2.3" Height for J-box/ Pipe/ EMB
CACM-DP-SM-BL-EMB	Surface Mount Canopy 2.3" Height for J-box/ Pipe/ EMB

## PENDANT MOUNT CANOPY

Model	Description
CACM-SH-PDM-WH	Pendant Canopy 0.75" Height: Fixed or Slanted
CACM-SH-PDM-BL	Pendant Canopy 0.75" Height: Fixed or Slanted

## PENDANT MOUNT DEEP CANOPY

Model	Description
CACM-DP-PDM-WH	Pendant Canopy 2.3" Height: Fixed or Slanted J-box for pipe or EMB
CACM-DP-PDM-BL	Pendant Canopy 2.3" Height: Fixed or Slanted J-box for pipe or EMB

## SURFACE MOUNT EMB DEEP CANOPY

Model	Description
CACM-DP-PDM-WH-EMB	Surface Mount Canopy 2.3" Height for J-box/ Pipe/ EMB
CACM-DP-PDM-BL-EMB	Surface Mount Canopy 2.3" Height for J-box/ Pipe/ EMB

## PENDANT MOUNT SJT CORDS

Model	Description	Model	Description
SJT-18-5-7FT-WH	7' 5-Wire White Cord	SJT-18-5-7FT-BL	7' 5-Wire Black Cord
SJT-18-5-12FT-WH	12' 5-Wire White Cord	SJT-18-5-12FT-BL	12' 5-Wire Black Cord

## SURFACE MOUNT STEMS

Model	Description
CACM-STM-1FT-WH	1ft Stem Mount - (Connect up to 11ft)
CACM-STM-1FT-BL	1ft Stem Mount - (Connect up to 11ft)