

ARCY-Line: Cylinder Downlights

CACM Modules



3"



4"

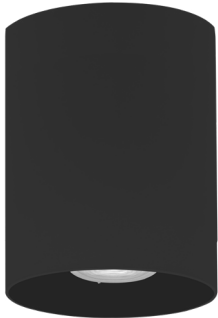

6"



STEM HUNG



CORD HUNG



SURFACE MOUNT

Detail Specifications:

- Housing Finish: White or Black
- Reflector Finish: White, Black, Clear-Specular Haze
 - Fixture includes same color reflector as housing standard
- Wet Location Rated
- Beam Angle Adjustable:
 - 3": 25-80°
 - 4 & 6": 35-60°
- Chip: COB, R9 >50, CRI >90
- Low UGR <22
- 5-CCT: 27/30/35/40/50k
- 3 Step MacAdam Ellipses
- Operating Temperature: -40° - 114° F
- Lens: Clear PC, non-yellowing
- Average life (L70) of 70,000 hours

Applications:

- General Recessed Lighting
- General Suspended & Pendant Lighting
- Residential & Multifamily
- Office, Hallways and Meeting Rooms
- Education, Healthcare, Retail, Hospitality
- Commercial Lighting

Product Information:

- Deep reflector lens reduces glare and optimizes even beam distribution
- Push-in/pull-out reflector: reflector insert and colors can be swapped
- Adjust the beam angle in the field by hand
- Select-n-Switch Technology: 5-CCT + 3-Power Selectable
 - Fixtures are preset to 5000k & max wattage

Driver Options:

- Voltage: UNV: 120-277V
- Tri-Mode Dimming: 0-10V, ELV, Triac
- Class II isolated, Flicker Free
- THD: <20% (+/-5% tolerance), PF >0.9, 50/60Hz
- Built in 2.5Kv Surge Protector

Mounting & Installation:

- Surface mount into 30 or 40 J-box
 - 0.75" height option available for recessed j-box
 - 2.3" height option available for surface mount j-box, pipe, emb
- Suspend with cord or cord + stem
- Can be removed from below the ceiling for service or replacement

Certifications:

- ETL Listed for USA and CA
- Energy Star Certified
- CA Title 24 JA8-2022, CEC T20 Listed
- 5 Year Limited Warranty
- FCC CFR 47, GCC Part 15, Subpart B:2017
- IC Rated
- ASTM-E283 Air-Tight

ORDERING GUIDE

| Series ¹ | Finish ² | Voltage | SJT Cord ³ |
|--|---------------------------------------|-----------------------|---------------------------------|
| LED-CACM-3-3P15-5CCT 3" Module | WH White | - UNV - 120 | (blank) No SJT cord |
| LED-CACM-4-3P15-5CCT 4" Module | BL Black | -277V | (select this for surface mount) |
| LED-CACM-4-3P25-5CCT 4" Module | BZ² Bronze | | 7FT 7' SJT |
| LED-CACM-6-3P25-5CCT 6" Module | GRY² Gray | | installed to fixture |
| LED-CACM-6-3P40-5CCT 6" Module | SLV² Silver | | 12FT 12' SJT |
| | CS² Custom Color | | installed to fixture |

Notes: Mounting hardware is not included with module.

Notes: White and black standard quick ship finish. Other finishes are made to order locally.

Select SJT 5-wire cord installed into fixture for cord or stem mounting. SJT is field cuttable to size. SJT is also available for field install.

| 3P15 | | 3P25 | | 3P40 | |
|------|--------|------|--------|------|--------|
| WATT | LUMENS | WATT | LUMENS | WATT | LUMENS |
| 15 | 1,400 | 25 | 2,500 | 40 | 4,000 |
| 10 | 950 | 20 | 2,000 | 35 | 3,500 |
| 5 | 500 | 10 | 1,000 | 30 | 3,000 |

SURFACE MOUNT OPTIONS

| Surface Mount Canopy 0.75" Height for recessed 30/40 j-box | Surface Mount Deep Canopy 2.3" Height for J-box/ Pipe/ Empty EMB Matching Body | Surface Mount EMB Deep Canopy 2.3" Height with EMB installed |
|---|---|---|
| CACM-SH-SM-WH White | CACM-DP-SM-WH White | CACM-DP-SM-WH-EMB White |
| CACM-SH-SM-BL Black | CACM-DP-SM-BL Black | CACM-DP-SM-BL-EMB Black |
| CACM-SH-SM-BZ¹ Bronze | CACM-DP-SM-BZ¹ Bronze | CACM-DP-SM-BZ-EMB¹ Bronze |
| CACM-SH-SM-GRY¹ Gray | CACM-DP-SM-GRY¹ Gray | CACM-DP-SM-GRY-EMB¹ Gray |
| CACM-SH-SM-SLV¹ Silver | CACM-DP-SM-SLV¹ Silver | CACM-DP-SM-SLV-EMB¹ Silver |
| CACM-SH-SM-CS¹ Custom Finish | CACM-DP-SM-CS¹ Custom Finish | CACM-DP-SM-CS-EMB¹ Custom Finish |

PENDANT MOUNT CANOPY OPTIONS (Must Purchase Cord)

| Pendant Mount Canopy 0.75" Height for recessed 30/40 j-box | Pendant Mount Deep Canopy 2.3" Height for J-box / Pipe Empty EMB Matching Body | Pendant Mount EMB Deep Canopy 2.3" Height with EMB |
|---|---|--|
| CACM-SH-PDM-WH White | CACM-DP-PDM-WH White | CACM-DP-PDM-WH-EMB White |
| CACM-SH-PDM-BL Black | CACM-DP-PDM-BL Black | CACM-DP-PDM-BL-EMB Black |
| CACM-SH-PDM-BZ¹ Bronze | CACM-DP-PDM-BZ¹ Bronze | CACM-DP-PDM-BZ-EMB¹ Bronze |
| CACM-SH-PDM-GRY¹ Gray | CACM-DP-PDM-GRY¹ Gray | CACM-DP-PDM-GRY-EMB¹ Gray |
| CACM-SH-PDM-SLV¹ Silver | CACM-DP-PDM-SLV¹ Silver | CACM-DP-PDM-SLV-EMB¹ Silver |
| CACM-SH-PDM-CS¹ Custom Finish | CACM-DP-PDM-CS¹ Custom Finish | CACM-DP-PDM-CS-EMB¹ Custom Finish |

PENDANT MOUNT SJT CORD OPTION (Must Purchase Cord with Pendant Mount Canopy) PENDANT MOUNT STEM OPTION (Power Cord Is Not Included)

| White Cords | Black Cords |
|-------------------------------------|-------------------------------------|
| SJT-18-5-7FT-WH 7' Cord | SJT-18-5-7FT-BL 7' Cord |
| SJT-18-5-12FT-WH 12' Cord | SJT-18-5-12FT-BL 12' Cord |

- Cord must be purchased in all pendant application. Cord is not included with stems.
- 5-Wire- White: Hot, Black: Neutral, Green: Ground, Purple/Gray: 0-10V Dimming wire. Do not connect in triac/elv applications and cap off.
- 6-wire is not needed in emergency options. Emergency backup location is inside of the canopy. Bring 24 hour power for EMB into the canopy only.
- Do not hang fixtures by more 11 feet by cord.
- Cords include quick connect for easy field installation. Cords may be factory ordered pre-installed to the fixture.

| Cords |
|---|
| CACM-STM-1FT-WH White |
| CACM-STM-1FT-BL Black |
| CACM-STM-1FT-BZ¹ Bronze |
| CACM-STM-1FT-GRY¹ Gray |
| CACM-STM-1FT-SLV¹ Silver |
| CACM-STM-1FT-CS¹ Custom Finish |

- Connect up to 11 stems together

Footnote:
1. Field installable. Lasts 90 minutes.

TESTED COMPATIBLE DIMMERS

Other dimmers may be compatible but have not been tested. Please contact us for more information.

| | |
|---------|-------------------|
| LEVITON | IP710-DLZ |
| SYNERGY | ISD BC 120/277 WH |
| EATON | SF10P-W |
| LUTRON | DVSTV-WH |
| HUBBELL | PSD710 |
| HUBBELL | RSD710Z |

ARCY-Line: Cylinder Downlights

CACM Modules

FEATURES

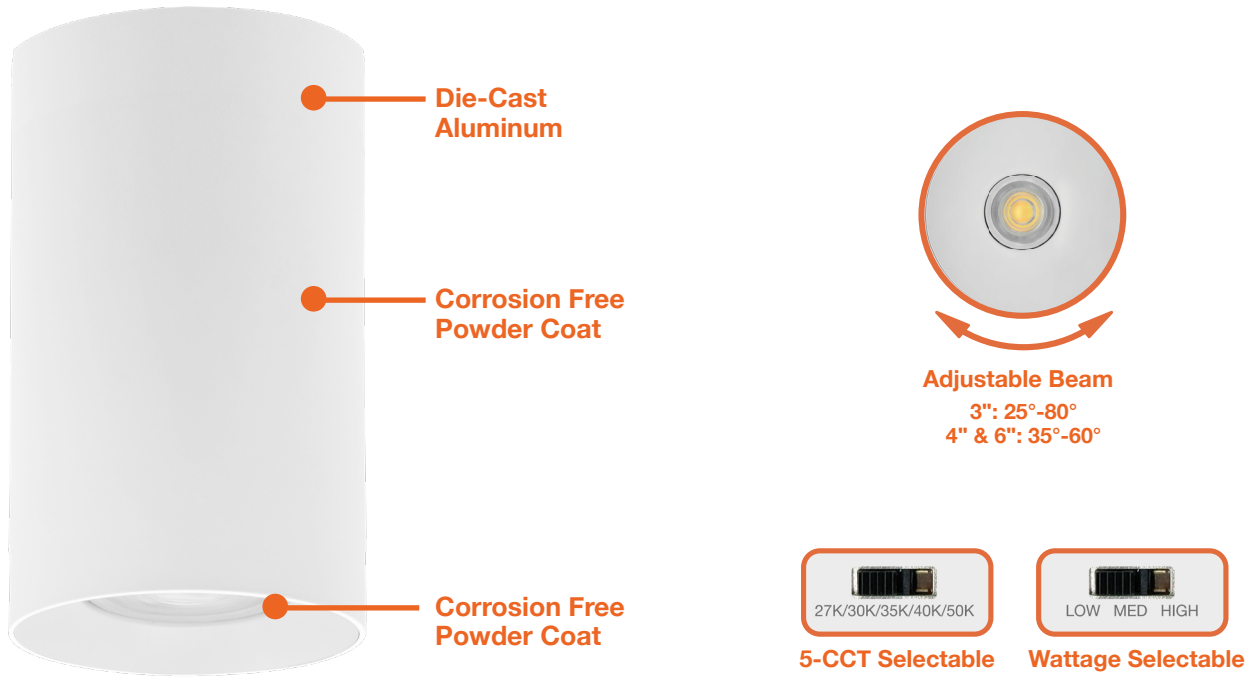

DIMENSIONS

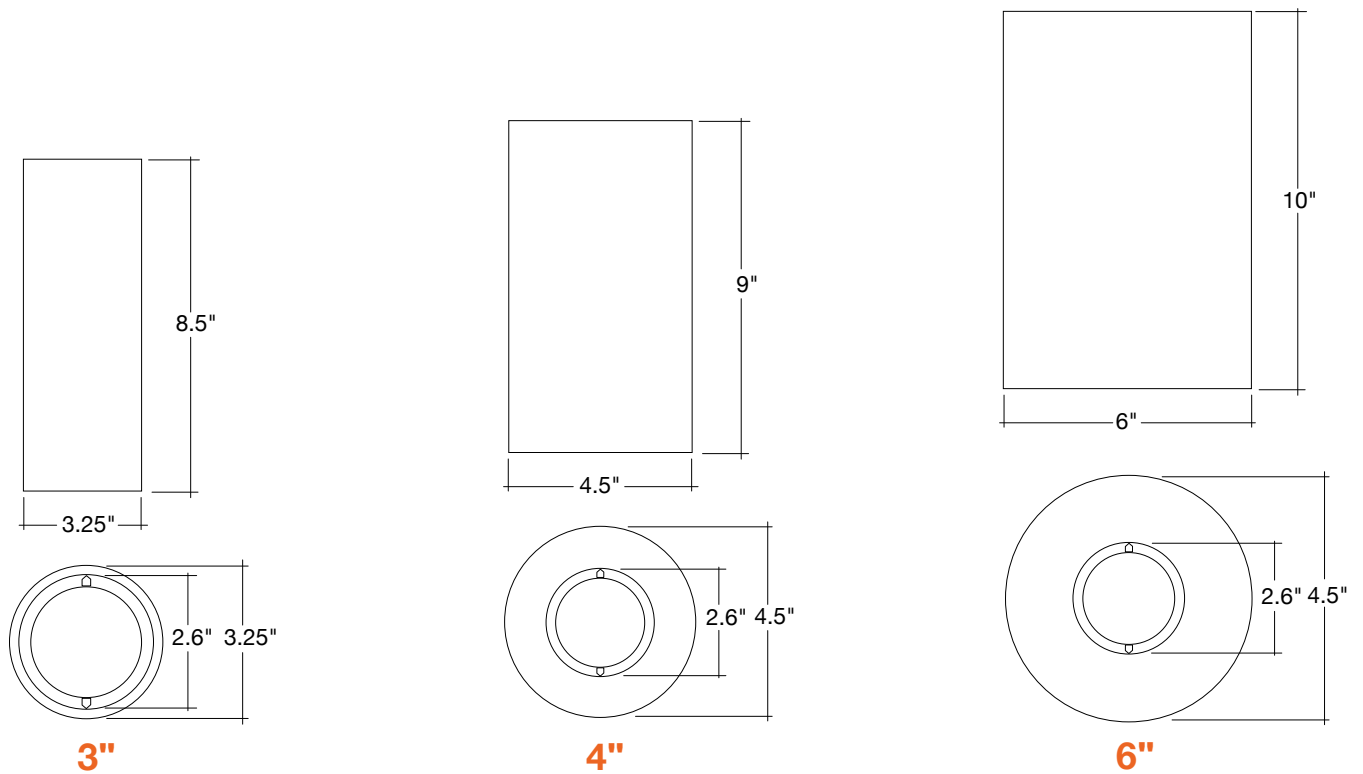

Specs and model numbers are subject to change with or without notice. Customization of product is available.

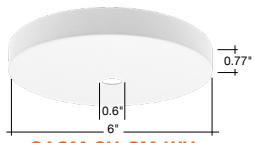

CACM-SH-SM-WH



CACM-SH-SM-BL

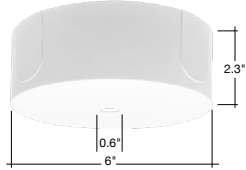

CACM-DP-SM-WH



CACM-DP-SM-BL

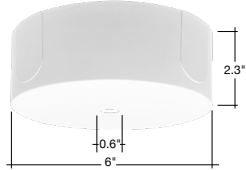

CACM-DP-SM-WH-EMB



CACM-DP-SM-BL-EMB

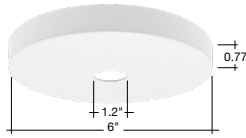

CACM-SH-PDM-WH



CACM-SH-PDM-BL

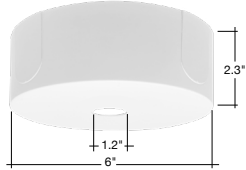

CACM-DP-PDM-WH



CACM-DP-PDM-BL

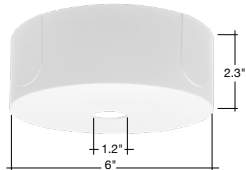

CACM-DP-PDM-WH-EMB



CACM-DP-PDM-BL-EMB



SJT-18-5-7FT-WH
SJT-18-5-12FT-WH



SJT-18-5-7FT-BL
SJT-18-5-12FT-BL

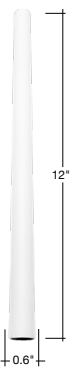

CACM-STM-1FT-WH



CACM-STM-1FT-BL

| Model | Voltage | Watts | Lumens | Color | CRI |
|-----------------------------|----------|-----------|-------------------|-----------------|-----|
| LED-CACM-3-3P15-5CCT-WH-UNV | 120-277V | 15/10/5w | 1,400/950/500 | 27/30/35/40/50K | >90 |
| LED-CACM-3-3P15-5CCT-BL-UNV | 120-277V | 15/10/5w | 1,400/950/500 | 27/30/35/40/50K | >90 |
| LED-CACM-4-3P15-5CCT-WH-UNV | 120-277V | 15/10/5w | 1,400/950/500 | 27/30/35/40/50K | >90 |
| LED-CACM-4-3P15-5CCT-BL-UNV | 120-277V | 15/10/5w | 1,400/950/500 | 27/30/35/40/50K | >90 |
| LED-CACM-4-3P25-5CCT-WH-UNV | 120-277V | 25/20/10 | 2,500/2,000/1,000 | 27/30/35/40/50K | >90 |
| LED-CACM-4-3P25-5CCT-BL-UNV | 120-277V | 25/20/10 | 2,500/2,000/1,000 | 27/30/35/40/50K | >90 |
| LED-CACM-6-3P25-5CCT-WH-UNV | 120-277V | 25/20/10 | 2,500/2,000/1,000 | 27/30/35/40/50K | >90 |
| LED-CACM-6-3P25-5CCT-BL-UNV | 120-277V | 25/20/10 | 2,500/2,000/1,000 | 27/30/35/40/50K | >90 |
| LED-CACM-6-3P40-5CCT-WH-UNV | 120-277V | 40/35/30w | 4,000/3,500/3,000 | 27/30/35/40/50K | >90 |
| LED-CACM-6-3P40-5CCT-BL-UNV | 120-277V | 40/35/30w | 4,000/3,500/3,000 | 27/30/35/40/50K | >90 |

SURFACE MOUNT CANOPY

| Model | Description |
|---------------|-----------------------------------|
| CACM-SH-SM-WH | Surface Mount Canopy 0.75" Height |
| CACM-SH-SM-BL | Surface Mount Canopy 0.75" Height |

SURFACE MOUNT DEEP CANOPY

| Model | Description |
|---------------|--|
| CACM-DP-SM-WH | Surface Mount Canopy 2.3" Height for J-box/ Pipe |
| CACM-DP-SM-BL | Surface Mount Canopy 2.3" Height for J-box/ Pipe |

SURFACE MOUNT EMB DEEP CANOPY

| Model | Description |
|-------------------|---|
| CACM-DP-SM-WH-EMB | Surface Mount Canopy 2.3" Height for J-box/ Pipe/ EMB |
| CACM-DP-SM-BL-EMB | Surface Mount Canopy 2.3" Height for J-box/ Pipe/ EMB |

PENDANT MOUNT CANOPY

| Model | Description |
|----------------|---|
| CACM-SH-PDM-WH | Pendant Canopy 0.75" Height: Fixed or Slanted |
| CACM-SH-PDM-BL | Pendant Canopy 0.75" Height: Fixed or Slanted |

PENDANT MOUNT DEEP CANOPY

| Model | Description |
|----------------|--|
| CACM-DP-PDM-WH | Pendant Canopy 2.3" Height: Fixed or Slanted J-box for pipe or EMB |
| CACM-DP-PDM-BL | Pendant Canopy 2.3" Height: Fixed or Slanted J-box for pipe or EMB |

SURFACE MOUNT EMB DEEP CANOPY

| Model | Description |
|--------------------|---|
| CACM-DP-PDM-WH-EMB | Surface Mount Canopy 2.3" Height for J-box/ Pipe/ EMB |
| CACM-DP-PDM-BL-EMB | Surface Mount Canopy 2.3" Height for J-box/ Pipe/ EMB |

PENDANT MOUNT SJT CORDS

| Model | Description | Model | Description |
|------------------|-----------------------|------------------|-----------------------|
| SJT-18-5-7FT-WH | 7' 5-Wire White Cord | SJT-18-5-7FT-BL | 7' 5-Wire Black Cord |
| SJT-18-5-12FT-WH | 12' 5-Wire White Cord | SJT-18-5-12FT-BL | 12' 5-Wire Black Cord |

SURFACE MOUNT STEMS

| Model | Description |
|-----------------|---------------------------------------|
| CACM-STM-1FT-WH | 1ft Stem Mount - (Connect up to 11ft) |
| CACM-STM-1FT-BL | 1ft Stem Mount - (Connect up to 11ft) |