

Installation Instructions

WARNING: Turn the power OFF from electrical panel before installation or maintenance.

- DO NOT modify this fixture. Any modifications may render the product unsafe and void warranty.
- This product is suitable for wet locations

FIXTURE INSTALLATION

- STEP 1:** Measure distance from walls and mark position of fixture to be installed on the ceiling.
STEP 2: Carefully scribe hole template in accordance to cut hole size on desired location.
STEP 3: Carefully cut hole in ceiling (Fig. 1)
STEP 4: Electrical connections
STEP 5: Select color temperature
STEP 6: Connect hardwire box to engine by connecting the quick male and female connector (Fig. 2)
STEP 7: Pass the hardwire box and attached by cable through the hole and place on straight surface inside the ceiling cavity (Fig. 3)
STEP 8: Push the spring slip up towards the LED engine (Fig. 4)
STEP 9: Push the fixture through the hole until the trim is flush with the ceiling. Spring clip will retract to hold trim in place.

DIMENSIONS

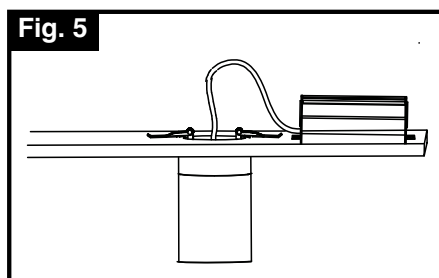
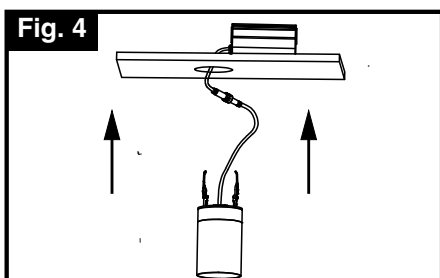
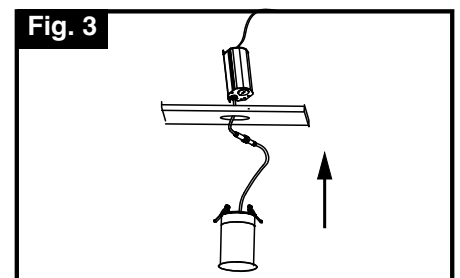
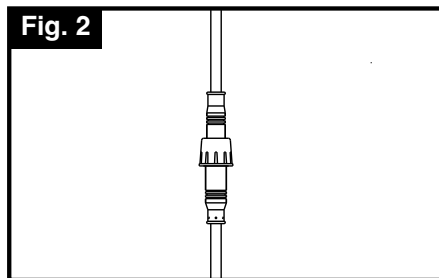
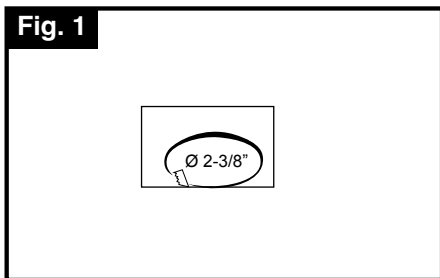
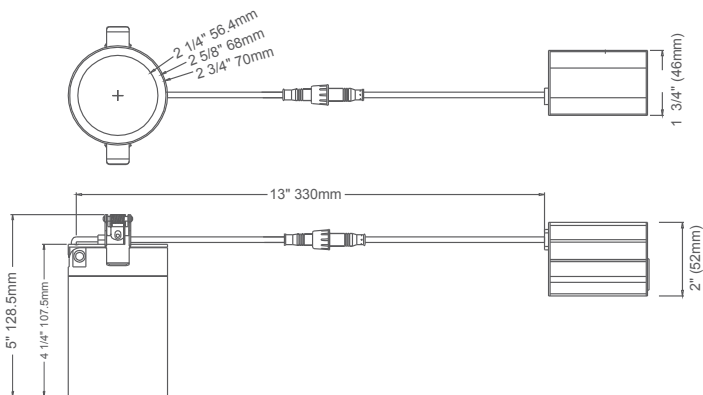

 Cutout:
2-3/8" (60mm)