

# 4" LED Regressed Downlight

**IMPORTANT:** READ ALL INSTRUCTIONS BEFORE INSTALLING FIXTURES. KEEP FOR FUTURE REFERENCE.

**SAFETY:** FOR YOUR SAFETY, THIS FIXTURE MUST BE WIRED IN ACCORDANCE TO LOCAL ELECTRICAL CODES AND ORDINANCES. ALL WORK SHOULD BE DONE BY A QUALIFIED ELECTRICIAN.

**WARNING:** MAKE SURE POWER IS OFF FROM THE ELECTRICAL PANEL BEFORE STARTING INSTALLATION OR ATTEMPTING ANY MAINTENANCE. INDOOR INSTALLATION ONLY.

TOOLS REQUIRED: SAW, MEASURING TAPE, ELECTRICAL WIRING USE TAPE AND GAUGE SUITABLE FOR APPLICATION TO CONNECT THE FIXTURES.

## PRE-INSTALLATION:

1. Mount the appropriate trim (Round or Square) on the module.
2. Twist the trim to lock on the module securely
3. Turn power OFF from the electrical panel before starting installation
4. Locate a suitable position to place the fixture and open in accordance to the cutout dimensions (Refer to cutout template) for appropriate size.
5. Run electrical wire from the switch (power supply) through the mounting hole. Use NMD90 Romex or BX cable.

## DRIVER WIRING:

1. Open the hardwire box swing cover and remove the appropriate knockout(s).
2. Insert the electrical supply cable through the knockout and secure with a cable connector (sold separately).
3. Using wire nuts, connect green ground wire of cable to green wire on box. Connect black wire of cable to black wire of box. (Fig. 2)
4. Place all wiring and connections back into the box and close the cover.
6. Insert hardwire box through the mounting hole. (Fig. 3)

NEW CONSTRUCTION APPLICATIONS: Hardwire box shall be firmly secured to studs, joists, or similar fixed structural units.

REMODEL APPLICATIONS: Do not require the hardwire box to be firmly secured after the mounting plates, studs, joists, or structural units have been concealed.

## FIXTURE INSTALLATION:

1. Connect the fixture to the hardwire box by inserting and twisting the male/female connectors. (Fig. 5)
2. Push spring loaded clips on the fixture upwards and insert fixture base into the mounting hole. Release the clips and fixture will be pulled flush to the ceiling. (Fig. 6)
3. Once assembly is complete, turn on power to confirm fixture is working properly.

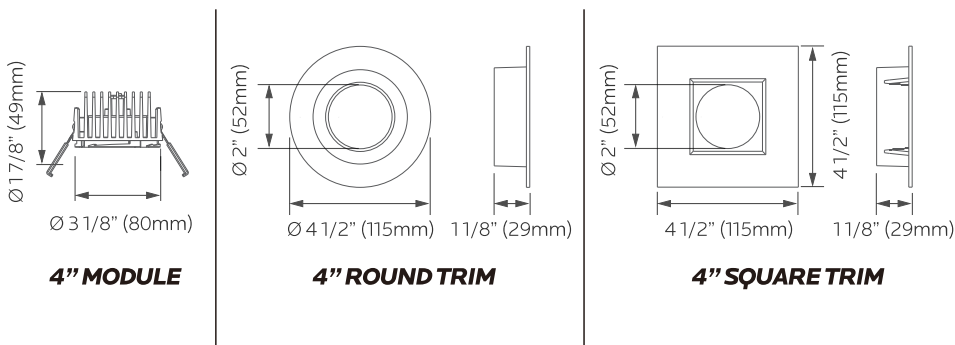
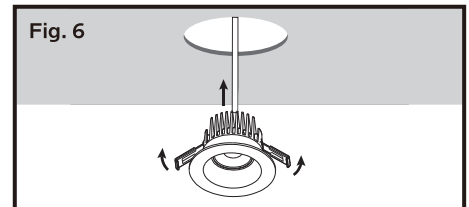
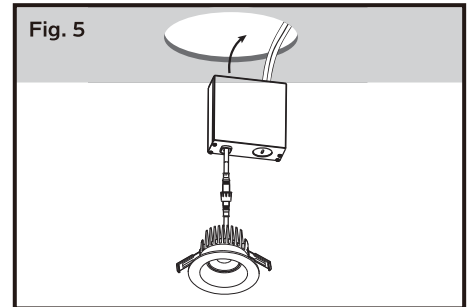
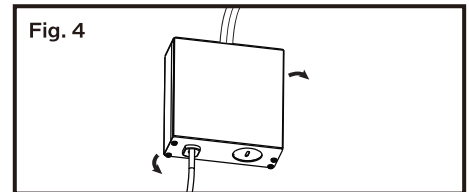
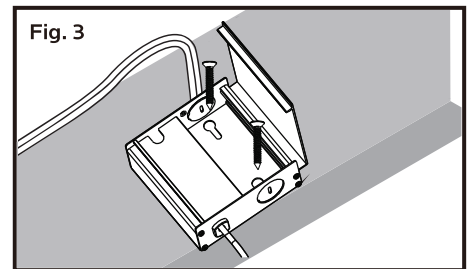
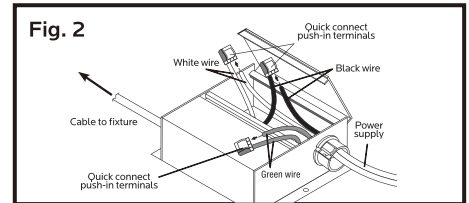
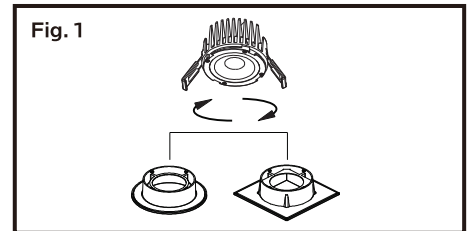

 Cutting Diameter:  
3.75" (95mm)