

LED SMART DOWNLIGHT RGB+W INSTRUCTIONS

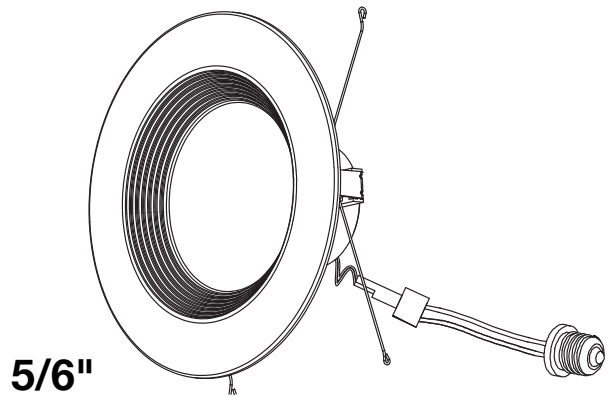
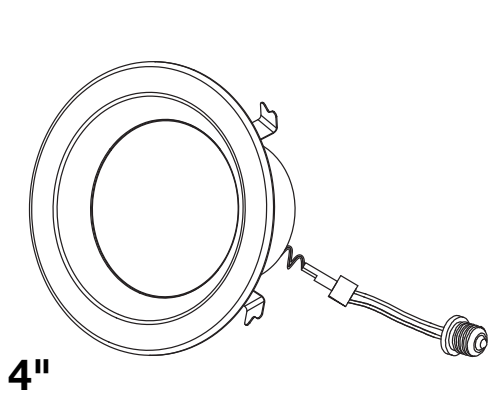

SAFETY INSTRUCTIONS

Please read and understand all instructions before operate or install the product. Failure to do so may lead to electric shock, fire or other injuries that could be hazardous or even fatal.

- Shut off the electricity to the wires that you are working on.
- Do NOT open, no user serviceable parts inside. Any changes or modifications and applications not expressly approved by the manufacturer could void the user's authority to operate the equipment and warranty.

WARNING

- Risk of fire or electric shock.
- LED retrofit kit installation requires knowledge of luminaires electrical systems. Do NOT attempt installation if not qualified. Contact a qualified electrician.
- Install this kit only in the luminaires that have the construction features and dimensions shown in the photographs and/or drawings.
- Do NOT exceed the input rating of the luminaire.
- Do NOT make or alter any open holes in an enclosure of wiring or electrical components during installation.
- To prevent wiring damage or abrasion, do NOT expose wiring to edges of sheet metal or other sharp objects.
- This device is not intended for use with emergency exits.
- This Luminaire has been modified to operate LED lamp. Do NOT attempt to install or operate incandescent lamps or CFL in this luminaire.
- Suitable for TYPE IC or TYPE NON-C luminaires.
- This retrofit kit is accepted as a component of a luminaire where the suitability of the combination shall be determined by authorities having jurisdiction.

CAUTION

- Connect fixture to a 120 Volt, 60Hz power source only. Any other connection void the warranty.
- This device complies with Part 15 of the FCC Rules. Operation is subject to the following two conditions: (1) This device may not cause harmful interference, and (2) this device must accept any interference received, including interference that may cause undesired operation.
- This equipment has been tested and found to comply with the limits for a Class B digital device, pursuant to part 15 of the FCC Rules. These limits are designed to provide reasonable protection against harmful interference in a residential installation. This equipment generates, uses and can radiate radio frequency energy and, if not installed and used in accordance with the instructions, may cause harmful interference to radio or television reception, which can be determined by turning the equipment off and on.
- The user is encouraged to try to correct the interterence by one or more of the following measures:
- Reorient or relocate the receiving antenna.
 - Increase the separation between the equipment and the receiver.
 - Connect the equipment into an outlet on a circuit different from that to which the receiver is connected.
 - Consult the dealer or an experienced radio/TV technician for help.

4" Model

Figure 1

Remove the recessed can light from existing can housing.
Screw adapter into socket in the can housing

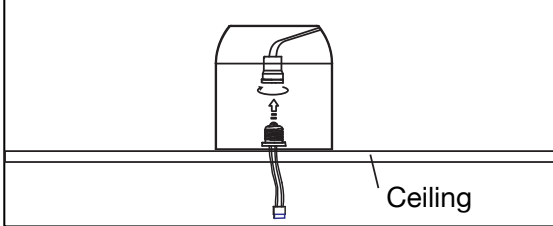

Figure 2

Plug cable connector on adapter into the downlight

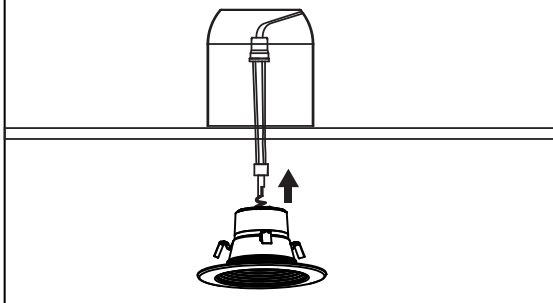
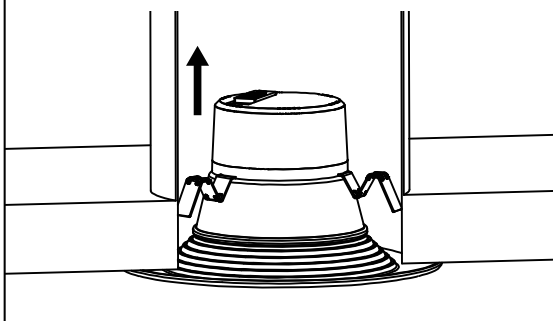

Figure 3

Push the downlight to fit in the can



5/6" Model

Figure 1

Remove the recessed can light from existing can housing.
Screw adapter into socket in the can housing

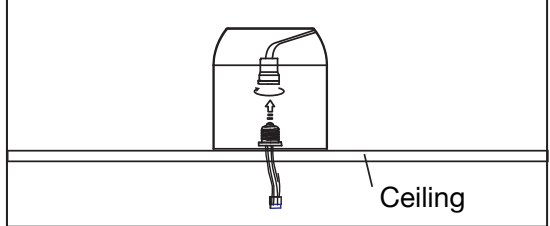

Figure 2

Plug cable connector on adapter into the downlight

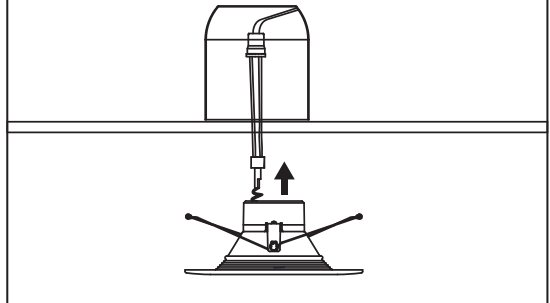

Figure 3

Squeeze the spring clip arms on both sides and hook the clip arms into the arm hooks on the inside of the can housing

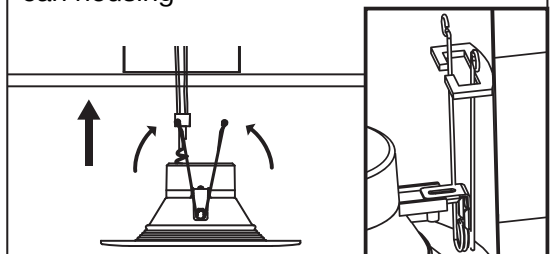
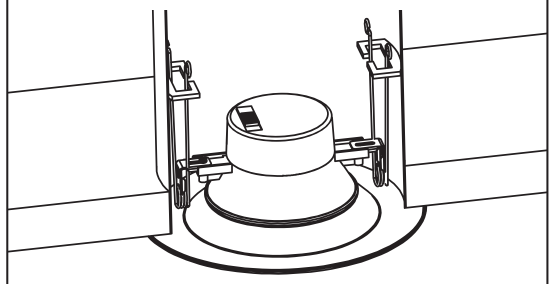
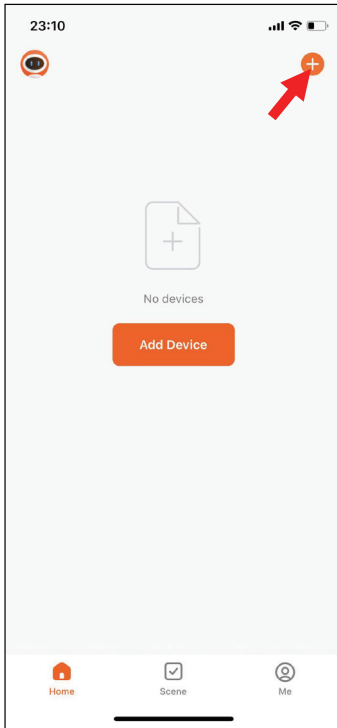

Figure 4

Release clip arms and push the downlight into the can housing



ADDING DEVICE



STEP 1

CLICK **+** TO FIND YOUR DEVICE. ADD TO ENVISION CONNECT APP

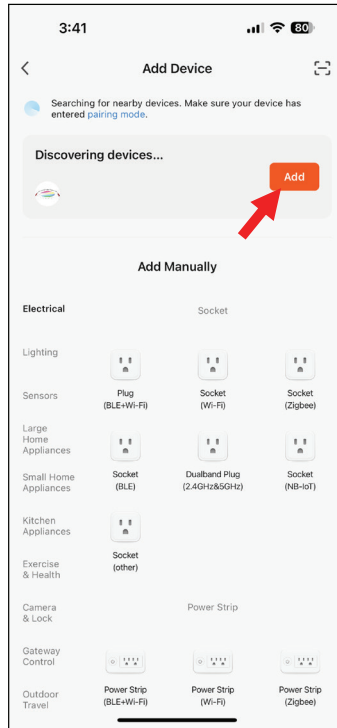

STEP 2

CLICK **Add** TO CHOOSE THE DEVICE TO ENVISION CONNECT APP

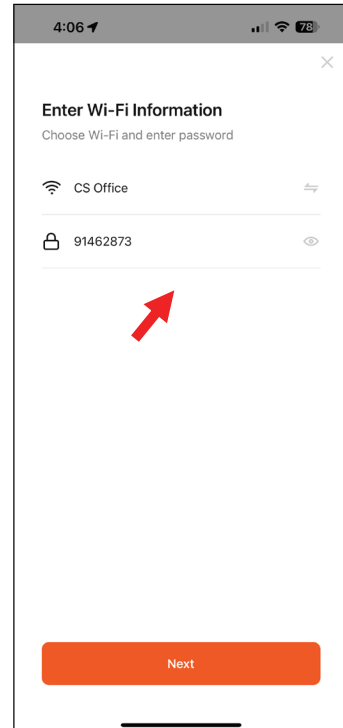

STEP 3

SELECT WIFI CONNECTION

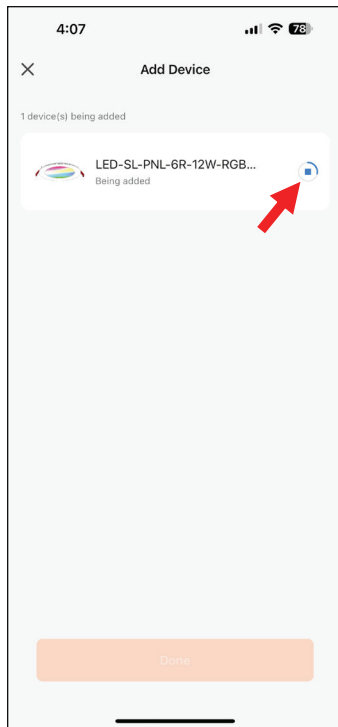

STEP 4

 SHOWS YOUR DEVICE IS BEING ADDED TO YOUR ENVISION CONNECT APP

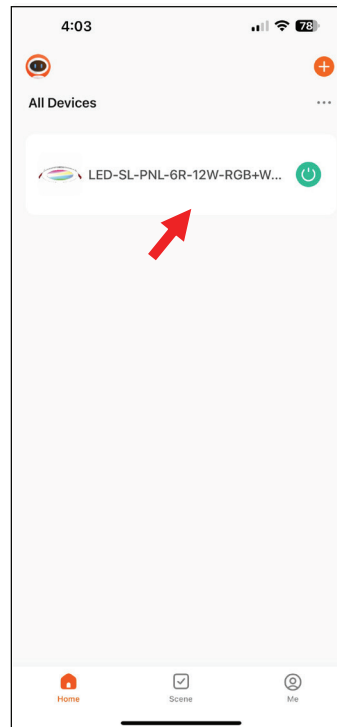

STEP 5

 CLICK DEVICE TO VIEW FULL FUNCTION OF THE ENVISION CONNECT APP

HOME



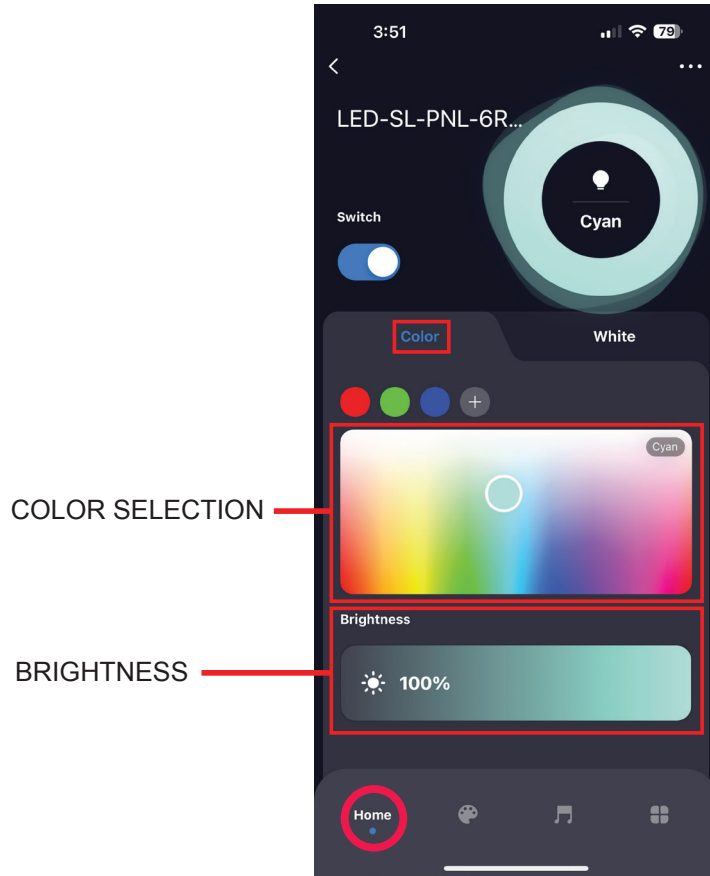



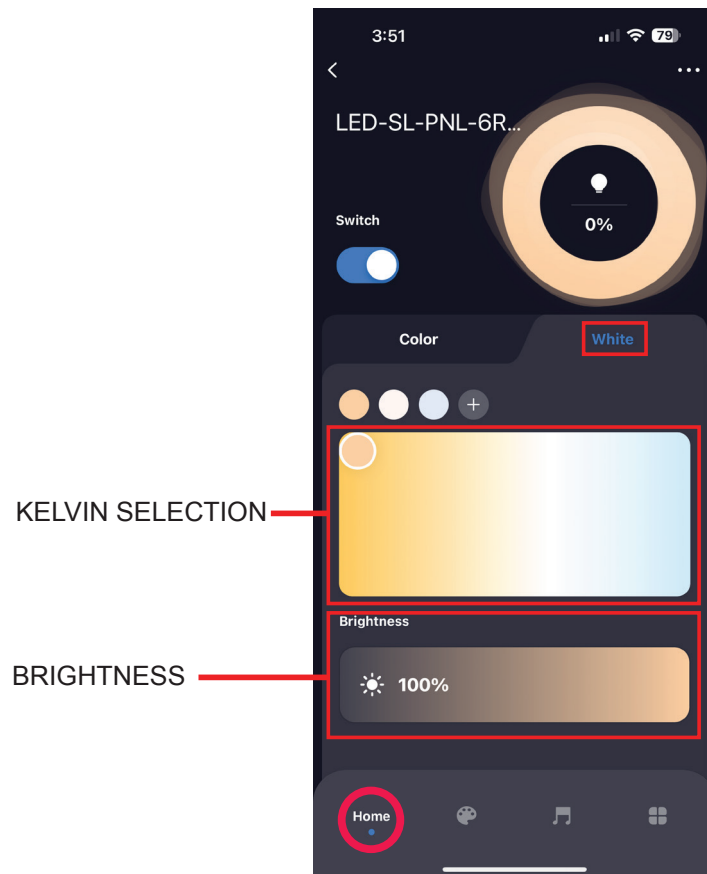



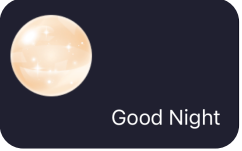

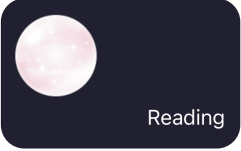
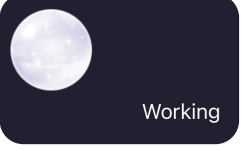
RGB COLOR SELECTABLE

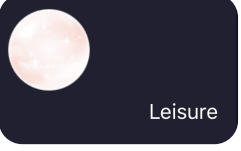

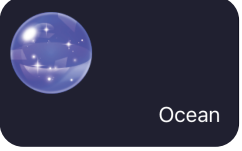
KELVIN SELECTABLE

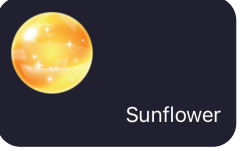

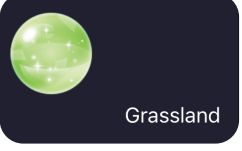
SCENE

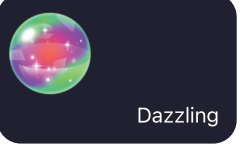
  Good Night NIGHT TIME COLOR	  Reading COMFORTABLE READING COLOR
  Working COMFORTABLE WORKING COLOR	  Leisure COMFORTABLE LEISURE COLOR
  Ocean OCEAN COLOR (DARK/LIGHT BLUE COLOR BLEND)	  Sunflower SUN COLOR (YELLOW/ORANGE COLOR BLEND)
  Grassland GRASSLAND COLOR (GREEN/LIGHT GREEN COLOR BLEND)	  Dazzling RGB COLOR (RED/GREEN/BLUE COLOR BLEND)

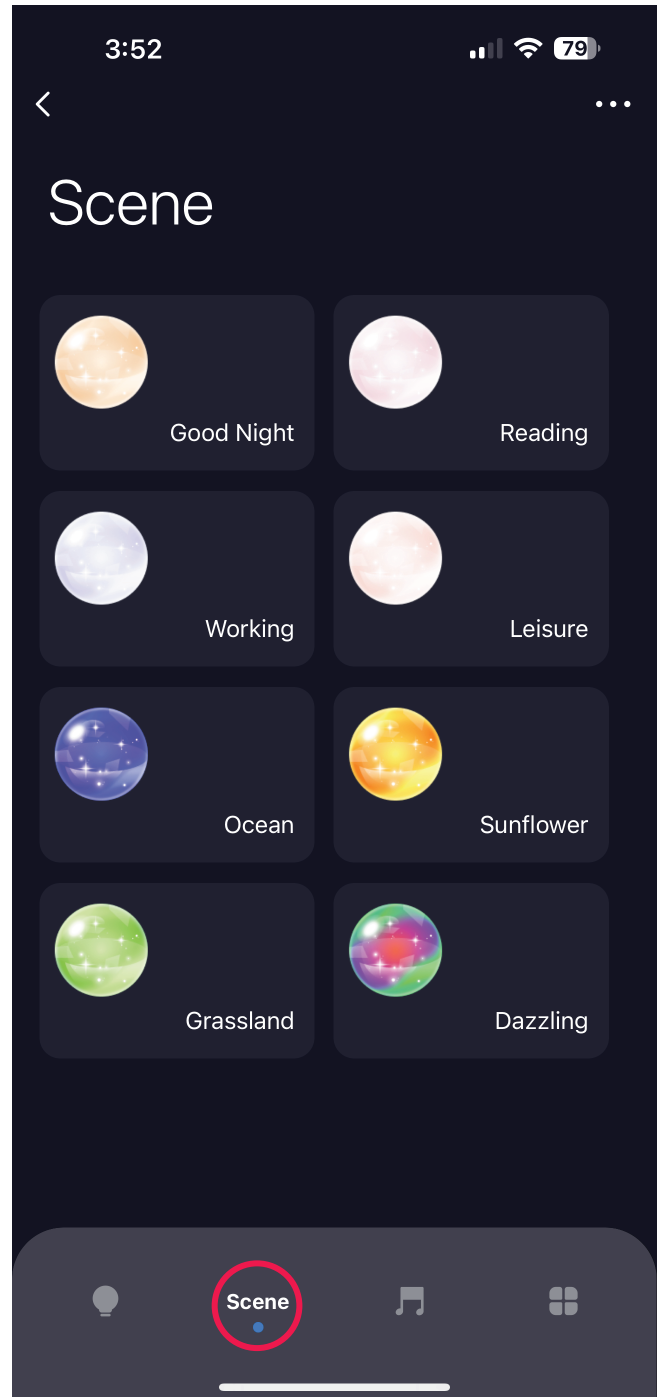

MUSIC



MUSIC RHYTHM

The light follows the music which is heard from the phone microphone. (Make sure microphone on your phone device is active).



GAME

The light follows the gaming effects which is heard from the phone microphone. (Make sure microphone on your phone device is active).



ROMANTIC MUSIC

The light follows the romantic music which is heard from the phone microphone. (Make sure microphone on your phone device is active).

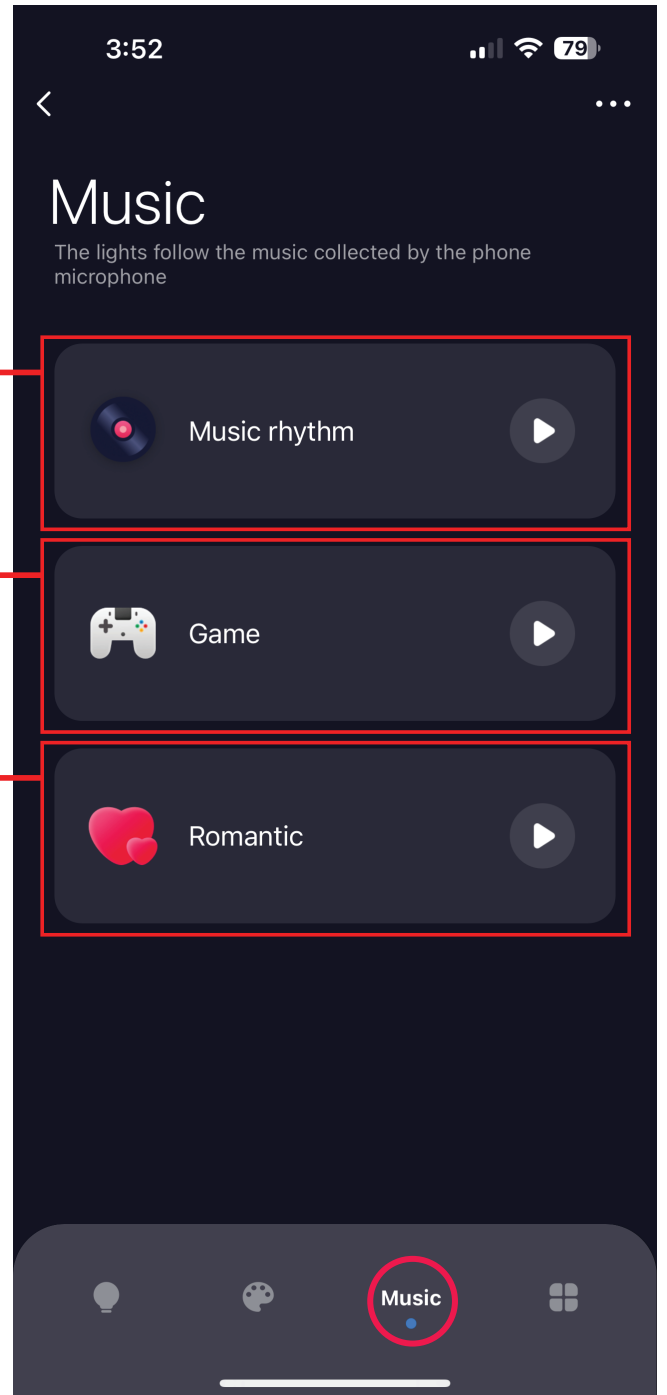

SETTING



ALARM SCHEDULE
Set your alarm to the time you have set-up.



Schedule



Do Not Disturb



DO NOT DISTURB
During power failure the light will not be disturbed.



DEFAULT LIGHT
Turn on light state when you turn on the power



Default Light



Remote Control



REMOTE CONTROL
Remote control to the light.

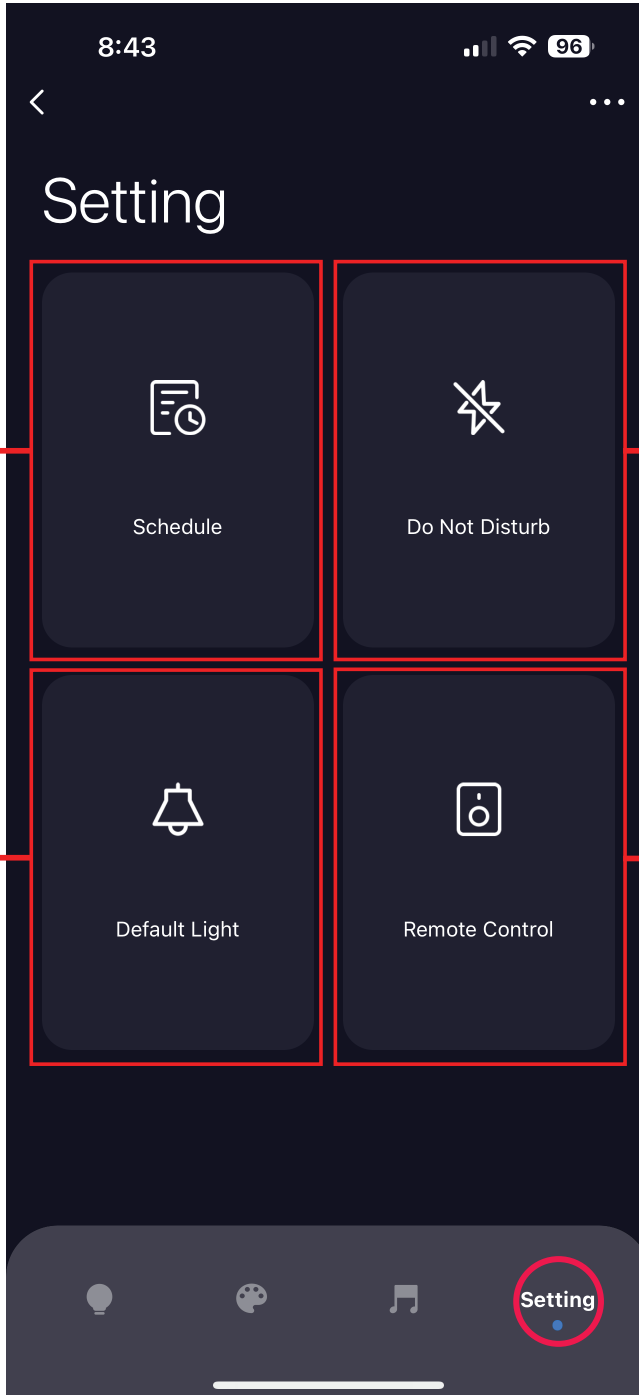

ALARM SCHEDULE

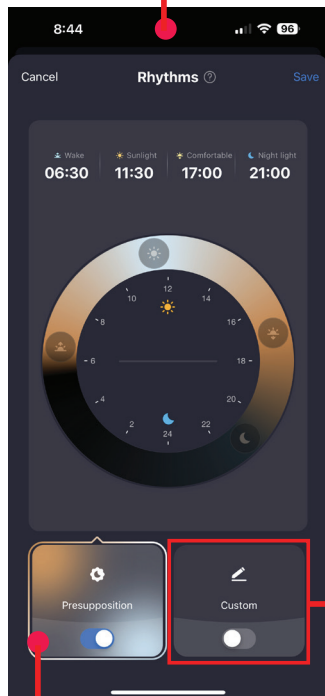
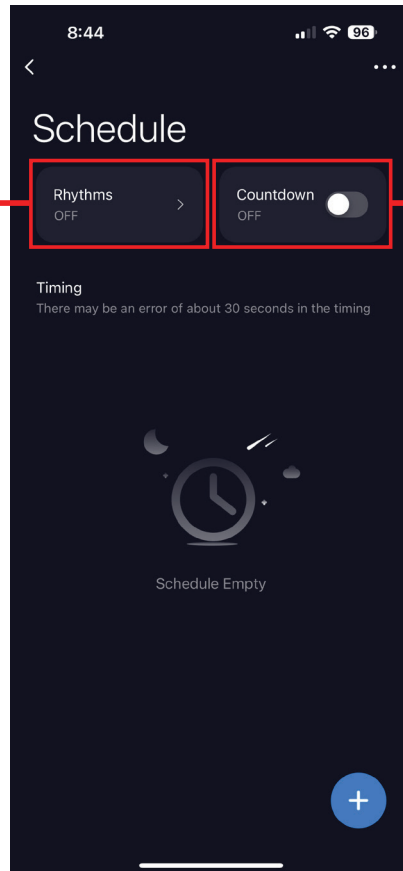

PRESUPPOSITION
Light set for color mode at dusk to dawn

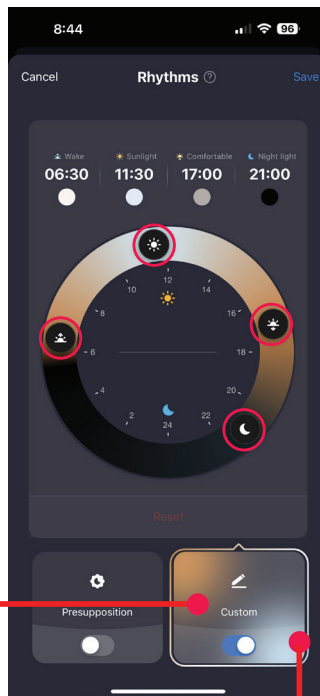

CUSTOM SET
Set Time For:
• WAKE
• SUNLIGHT
• COMFORTABLE
• NIGHT LIGHT

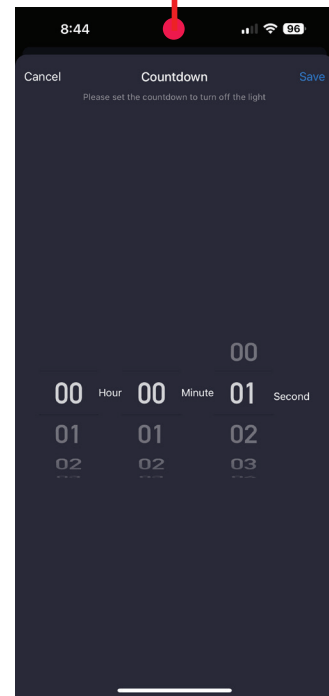

COUNTDOWN
Set a time to turn off light

DEFAULT LIGHT



RESTORE MEMORY

Color and brightness will be set when light is turned on.



INITIAL MODE

Color and brightness under setting mode.



CUSTOMIZED

Select Color and brightness

