

4" & 5/6" RGB + W Smart Downlight



4"



5/6"

With the EnVision LED Smart Downlight, unlock a whole new chapter of making your home more connected, with our simple dimming controls to advanced bluetooth remote settings. Set a timing schedule with the app that connects to the fixture, and even set color changes that change with music beats. Along with our anti-aging optical-grade PC lampshade and our energy saving, long lifespan high bright LED chips, use our downlights for recessed lighting, retrofitting, and general indoor lighting.

Applications:

- Residential Lighting
- Commercial Lighting
- Recessed Lighting
- General Indoor Lighting

Product Information:

- Choose between any color in the RGB spectrum, plus white
- Damp rated
- Driver: AC Driverless technology 120V
- High CRI>90 with CA Title 24/CEC/T20 Compliance

Note: Functions such as ON/OFF dimming, color changing, scheduling, grouping only controlled through app.



PHONE APP
ANDROID



PHONE APP
APPLE

LED - ECODL - *Size/Shape/Watts* **- RGB + W -** *EMB* **- Warranty**

1 **2** **3** **4** **5**

1 Product

LED-ECODL Smart Downlight w/ Bluetooth

2 Size/Shape/Watts

4-10.5W 4" / 10.5W (800lm)
5/6-12W 5/6" / 12W (1000lm)

3 Color

RGB+W RGB + White

4 EMB

(Blank) None
EMB Emergency Backup

5 Warranty

(Blank) 5 Year (incl.)
10YR 10 Year

Specs and model numbers are subject to change with or without notice.



4" & 5/6" RGB + W Smart Downlight

FEATURES

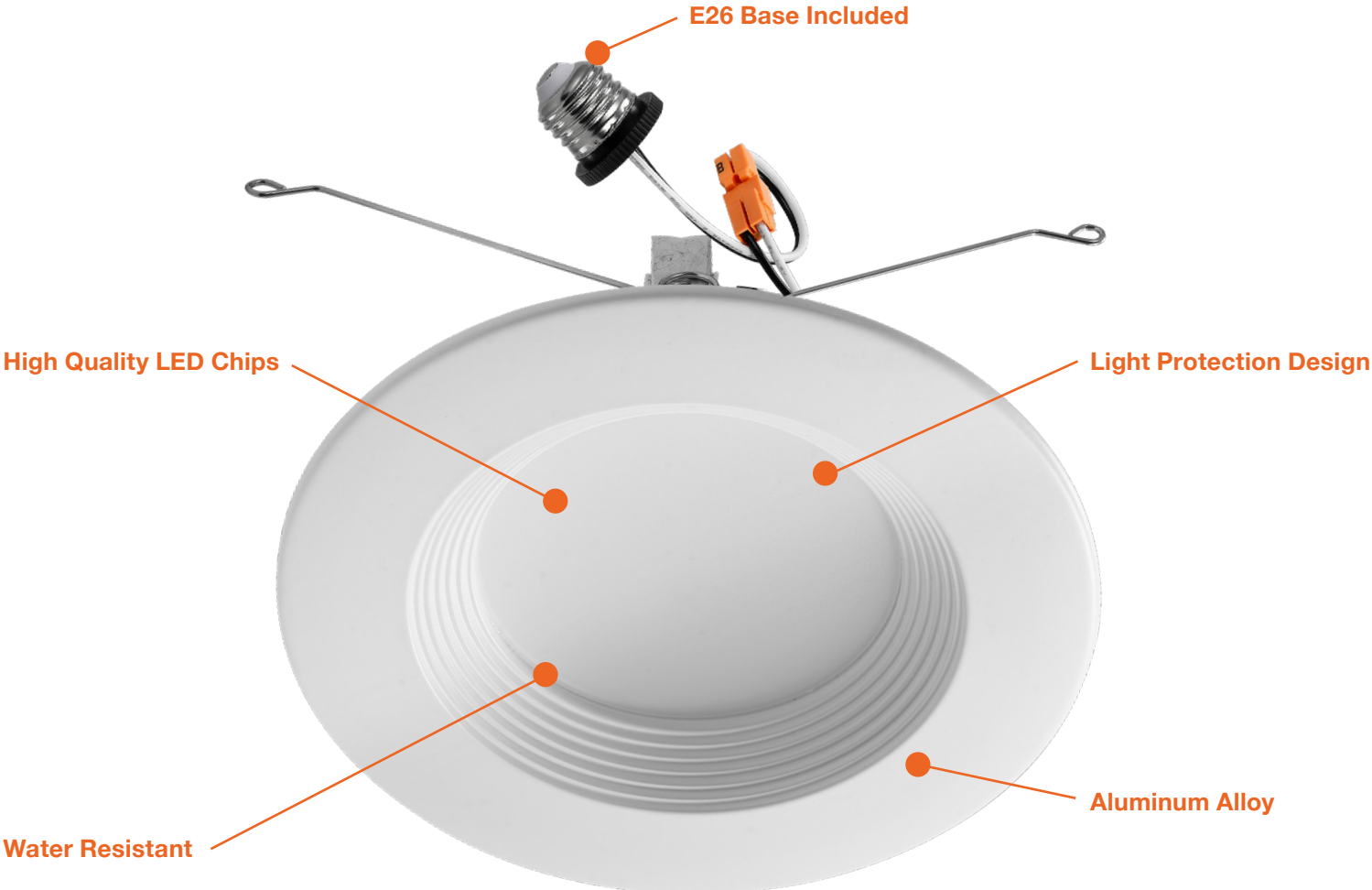

4" & 5/6" RGB + W Smart Downlight

DIMENSIONS

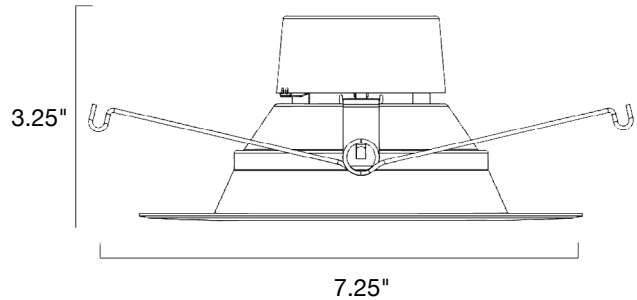
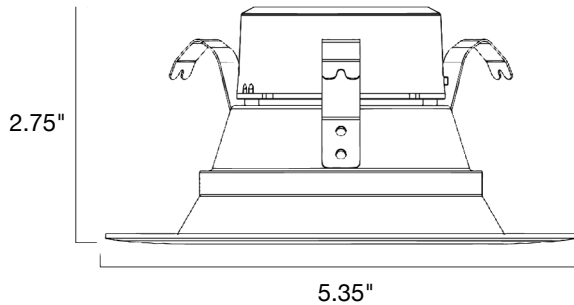

INSTALLATION

1. There are two ways to install our EnVision LED Smart Downlight. If you have an EZ Connect housing, simply connect the housing and then connect everything to the terminals. If you do NOT have an EZ Connect housing, install the adapter and then connect everything to the terminals.
2. Attach the torsion springs to the brackets of the recessed can.
3. Insert the LED Retrofit Kit into the recessed housing unit.

4" & 5/6"

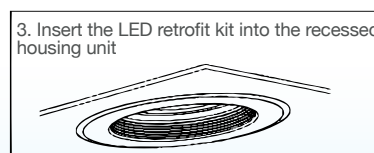
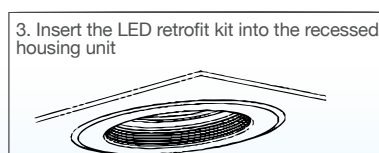
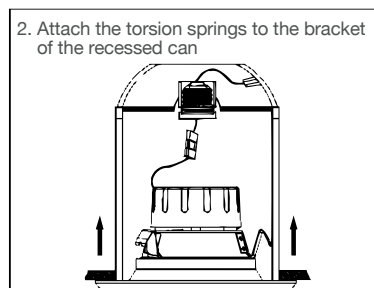
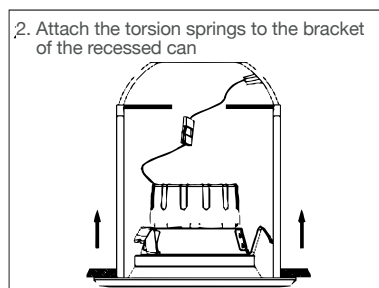
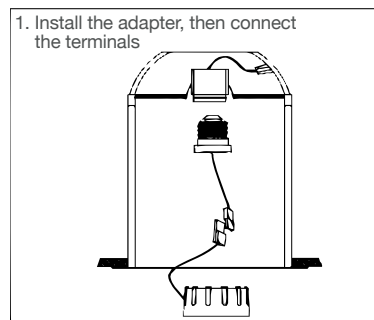
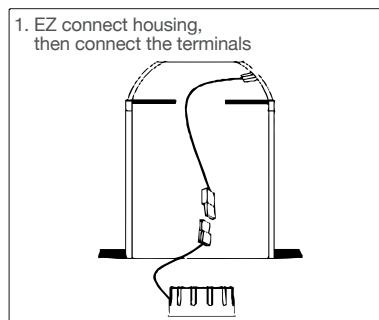

4" & 5/6" RGB + W Smart Downlight

PHOTOMETRICS

4"

Color Parameters

Chromaticity Coordinate: $x=0.4415$, $y=0.4098$

Chromaticity Coordinate: $u'=0.2510$, $v'=0.5243$

Ratio: R=26.0% G=71.2% B=2.8%

Peak WL: $L_p=620.0\text{nm}$ $HWL:155.1\text{nm}$

Photo Parameters

Flux: 675.23lm Fe: 2.3206 W Efficacy: 65.60lm/W

Electrical Parameters

Luminaire: U=120.4V I=0.093A P=10.29W PF=0.91

5/6"

Color Parameters

Chromaticity Coordinate: $x=0.4670$, $y=0.4204$

Chromaticity Coordinate: $u'=0.2627$, $v'=0.5321$

Ratio: R=28.2% G=69.5% B=2.3%

Peak WL: $L_p=620.0\text{nm}$ $HWL:142.2\text{nm}$

Photo Parameters

Flux: 1072.31lm Fe: 3.7552 W Efficacy: 69.72lm/W

Electrical Parameters

Luminaire: U=120.4V I=0.136A P=15.38W PF=0.94

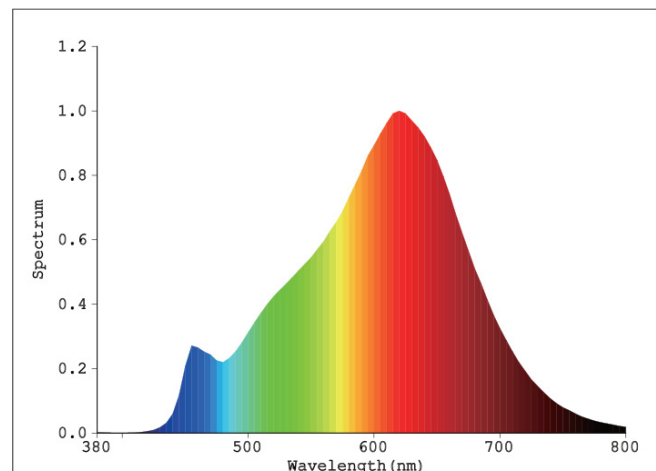
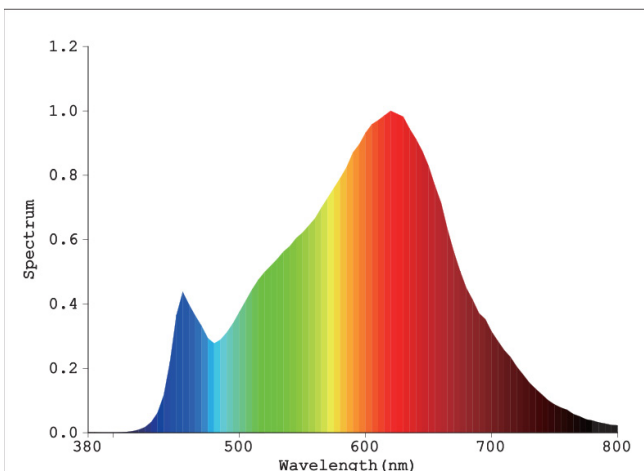
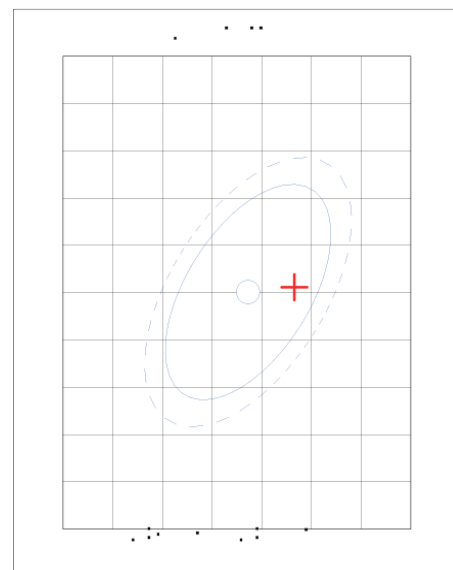
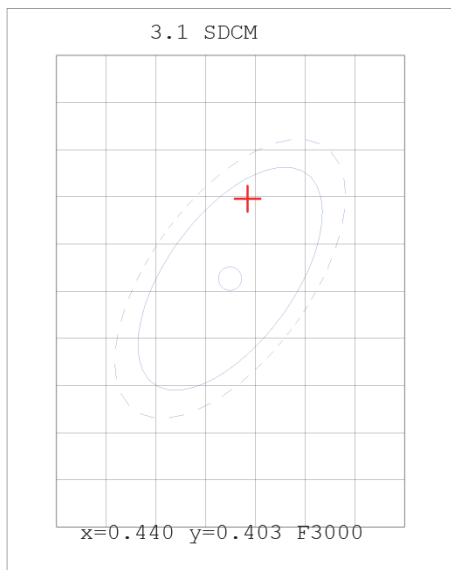

4" & 5/6" RGB + W Smart Downlight



BLUETOOTH CONTROL

Install the App (TUYA) or (ECOSMART) from your App Store.

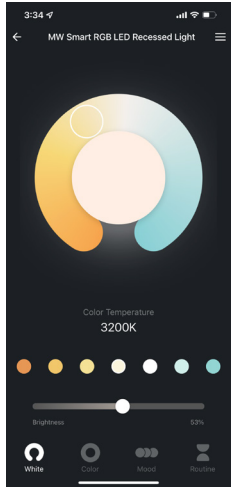

Install the App (TUYA) or (ECOSMART) from your App Store.

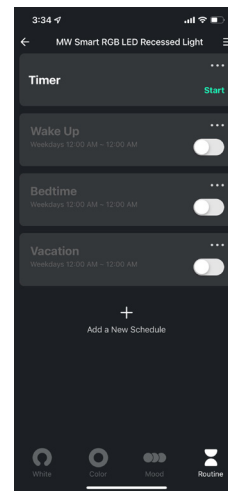
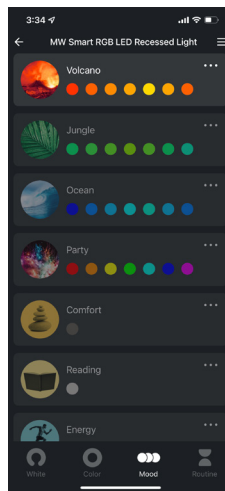
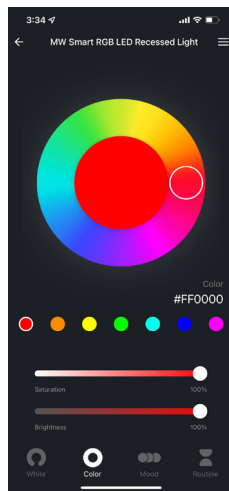

Image 3: With the fixture being connected to the app, the user can now create a room name for easier identification and control of the connected fixture.

Image 4: After the device is added successfully, the user can click the corresponding light to enter the device control interface and operate the light from this menu.