

INSTALLATION INSTRUCTIONS FOR RGB + 5-CCT LED HARDSCAPE LIGHTS

LED-HS-7I-5W-RGB+5CCT-ALM-BZ-LV















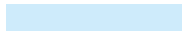



Warning - To reduce the risk of fire or injury

- Turn power OFF or unplug fixture and allow it to cool before removal.
- Luminaires gets HOT quickly. Contact only switch/pulg when turning on.
- Do not touch hot lens, guard, or fixture housing until it has cooled.
- Keep Luminaires away from combustibles or corrosive enviroment

IMPORTANT SAFETY INSTRUCTIONS

- For outdoor use only.
- Make sure the power is turned OFF before installing or servicing this fixture.
- WARNING: Risk of electrical shock. Install all fixtures 10 feet(3.05 m) or more from a pool, spa, or fountain.
- This fixture is to be used with a low voltage power supply that does not exceed 15V.
- Position the wire and wire connector so that it is connected within 6 inches (15.2 cm) from a building structure, a fixture or fitting.
- The fixture wiring should be buried at a depth of six inches or less to ensure connectivity to the main supply cable.

17 SCENE OPTIONS

| | | |
|--------|---|---|
| 2700K |  | RED/GREEN/BLUE  • 2 Second Smooth Color Change |
| 3000K |  | RED/GREEN/BLUE  • 2 Second Flash Color Change |
| 3500K |  | ALL COLORS  • 2 Second Smooth Color Change |
| 4000K |  | ALL COLORS  • 2 Second Flash Color Change |
| 5000K |  | ALL COLORS  • 2 Second Smooth Color Change + 2 Second Flash Color Change |
| WHITE |  | OFF  |
| RED |  | |
| GREEN |  | |
| BLUE |  | |
| ORANGE |  | |
| PURPLE |  | |
| CYAN |  | |

Push Button

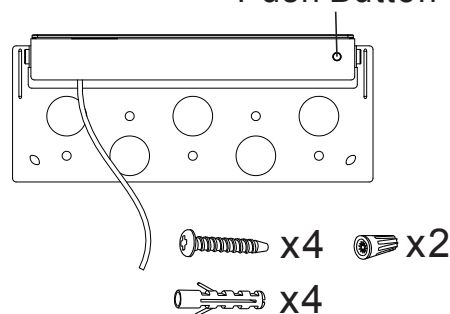

FIXTURE MOUNTING INSTRUCTIONS (MASONRY OR HARDSCAPES)

- 1) Disconnect the transformer from the main power supply.
- 2) Place the stainless steel mounting bracket between layers of hardscape material.
- 3) Route the fixture wire to the main supply cable leads following standard masonry procedures.
- 4) Strip the two fixture wires.
- 5) Attach the two fixture wires to the two main supply cable leads using waterproof connectors.
- 6) Reconnect the transformer to the primary power supply

NOTE: It is recommended that installers leave additional wire behind the wall that would allow for the fixture to be removed.

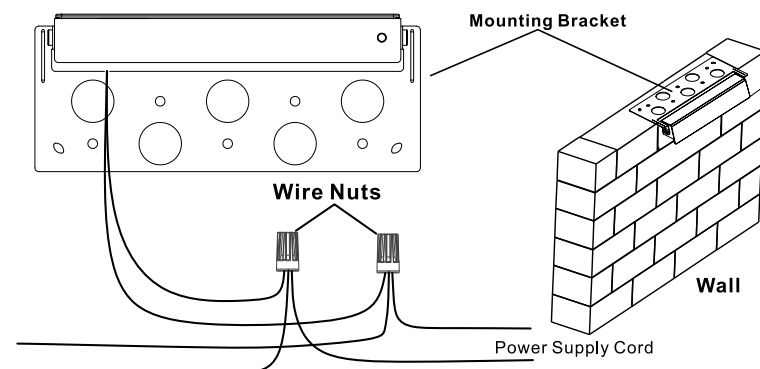

1. This swivel light head design allows you to adjust illumination angel from 0-180 degree(Horizontal 0-90 degree, Vertical 0-90 degree, rotation angle is subjected to actual application), please test it at night due to the setting for each project may vary.

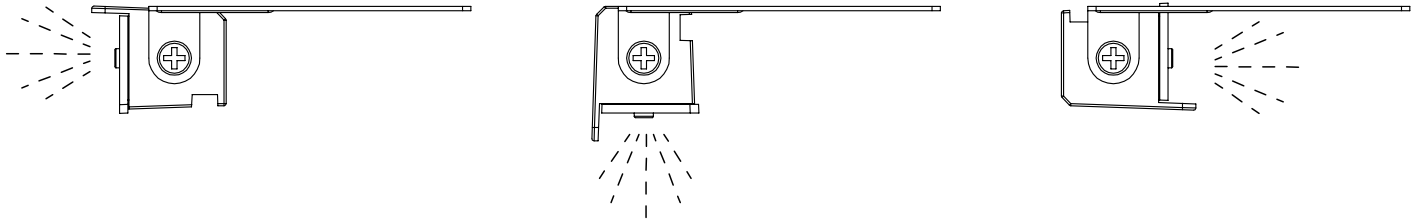

2. Some contractors prefer to "glue" the mounting plate with cement or hardscape glue (masonry/block adhesive), use pliers to bend the triangle corner until it fall down, then fill the cutting edge with cement or block adhesive so that it is fixed stable on the surface.



3. You can cut a groove to be at least 1/2 to 3/4 inches wide and deep and put the wire into the slot.



4. Put the mounting bracket on stone or cement surface, cut the mounting bracket along the dot line with grinder if you don't have enough installation room, which is only for your reference, cutting varies based on your actual application



5. Make sure your transformer is non-dimmable and range from 12-15VAC or DC

Light source module placement

1. Take out the module by hand directly, replace new one (See image below)

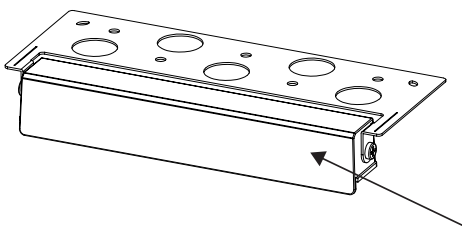

No Rewiring and Damage,
Take out the LED module.

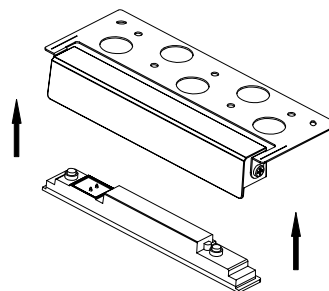

Take the right direction, put the new light module
into groove (magnetically mounted)