

LED Linear High Bay Installation Instruction

Cautions:

1. Do not use any electric generator to test the LED light.
2. Please abide by related country, regional and local law and regulations when installing this fixture.
3. Please turn off the power before installation or maintenance.
4. Proper earth grounding is required to ensure safety.

Notice:

1. To avoid possibility of electrical shock or fire, the installation personnel must have professional electric knowledge.
2. Please wear gloves to avoid injury before installation.
3. If any smoke or spark of the wire happened, please turn off the power immediately and notify relevant personnel.
4. Please use listed strain relief bushing when connecting the supply cord to the outlet box.

Attention:

1. Please check if there is any damage during shipping. If so, please contact manufacturer timely.
2. Please read the installation instruction carefully to check whether all the accessories are complete. After confirmation, install the fixture according to installation steps.

Wiring Diagram & Instruction:

3 dimming functions are available in this high bay light:

1. Constant current can be achieved by 0-10V dimming;
2. PWM signal dimming;
3. Variation of resistance unit dimming.

Description:	
This product is 0-10V dimming, below dimmers are recommended:	
Brand	Model
LUTRON	DVSTV-453

Wiring Instruction

L:Black,
N:White,
⊕ : Green/Yellow
DIM +
DIM -

(As for the wire color of DIM+ and DIM-, pls check the light label.)

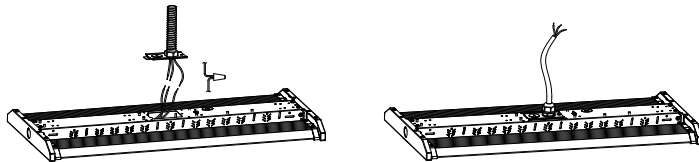

Please choose the appropriate dimming way according to your needs. You can also choose not to use this function.

*The product can not be connected to a dimming device when it's equipped with Motion Sensor.

Three Installation: Chain/Cable Installation, 3/4"NPT Installation, Surface Mounting
(Please choose the most suitable installation method for the purchased product as per your needs)

A.Hanging Installation:

- Step1.Hook up the chain; (Figure 1)
- Step2.Connect the chain with fixture; (Figure 1)
- Step3. Fix the chain on the rail, adjust the chain length as per need; (Figure 1)
- Step4.After fixed , choose suitable wiring knock out, and connect the wires according to local standard and code.
- Step5.The light-emitting modules can be rotatable, and the maximum angle of outward rotation is 135°. (Figure 2)

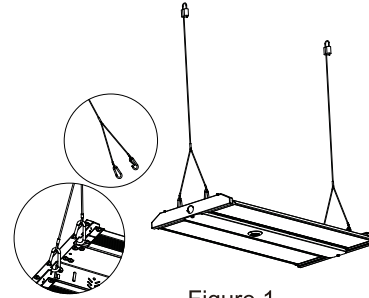

Figure 1

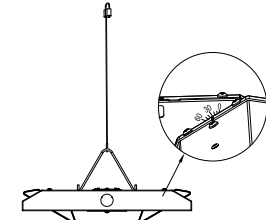

Figure 2

B.3/4"NPT Installation:

- Step1. Mount the bracket on 3/4"NPT; (Figure 3)
- Step2. Lock fixture on the bracket; (Figure 4)
- Step3. Connect the wires according to local standard and code;
- Step4. Lock side brackets with screwdriver; (Figure 5)
- Step5. After installation, rotate the light-emitting modules to get the best lighting angle you want (the maximum angle of outward rotation is 135°).



Figure 3

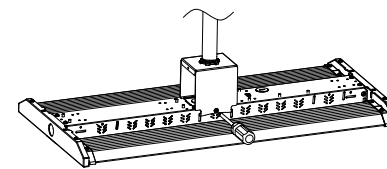

Figure 4

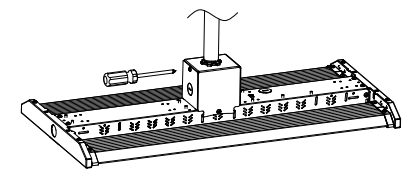

Figure 5

C.Surface Mounting: (If this bracket is used for the fixture, backup driver solution cannot be chosen)

- Step1. Mount the bracket on the rail or ceiling; (Figure 6)
- Step2. Assemble the lamp on the bracket and fix it with screws; (Figure 7)
- Step3. After fixed, choose suitable wiring knock out and connect the wires according to local standard and code;
- Step4. After installation, rotate the light-emitting modules to get the best lighting angle you want (the maximum angle of outward rotation is 135°).

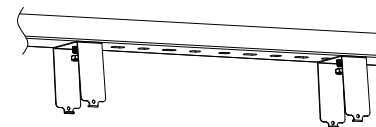

Figure 6

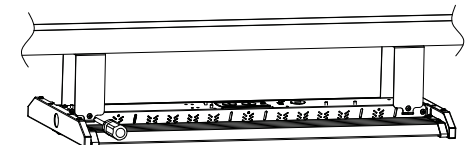

Figure 7

Extra Accessory Option Installation: 1:Wire Guard, 2:Motion Sensor / PIR Sensor,3: Backup driver

1.Wire Guard: (Purchase the correct size of wire guard from manufacturer)

Step1. Clamp the iron pieces on both ends of the wire guard into the plug of the light-emitting modules, push them to the end, and tighten them with screws. (Figure 8)

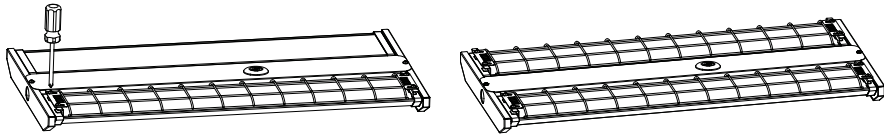

Figure 8

2-1. Motion Sensor / PIR Sensor: (Both sensor are with same installation)

Step1. Open the face cover with screwdriver; (Figure 9)

Step2. Knock out the side cover, mount the sensor on the side, connect the wires according to the sensor instruction; (Figure 10)

Step3. Mount the face cover back with screwdriver. (Figure 11)

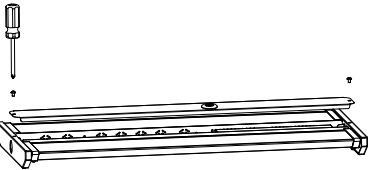

Figure 9

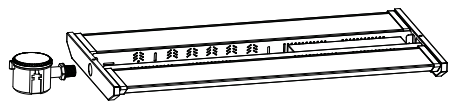
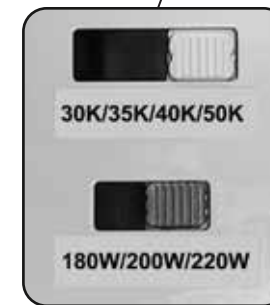
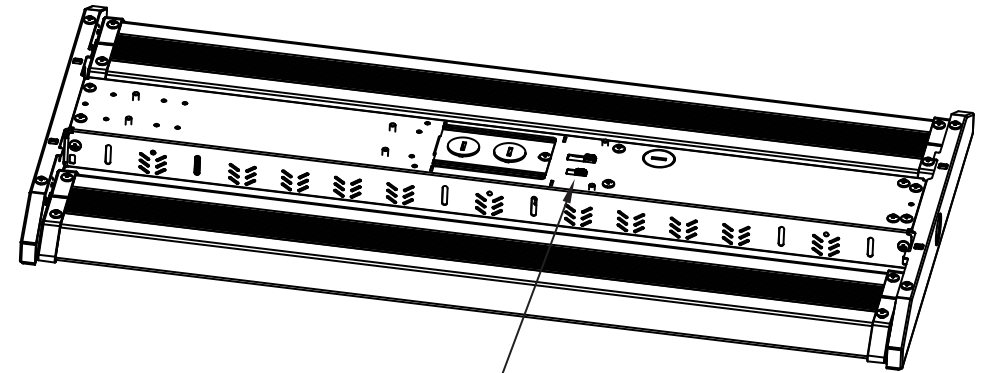
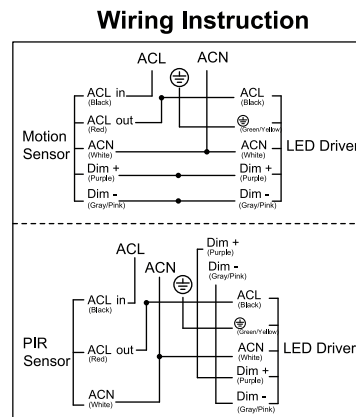

Figure 10



Figure 11



2-2. DC Motion Sensor / PIR Sensor (Both sensors are with the same installation method)

Step1. Use a screwdriver to remove the 1/2 plug from the sensor; (Figure 12)

Step2. Twist-lock the DC sensor to the base to make it work properly, use a remote control to adjust the working mode as per demand. (Figure 13)

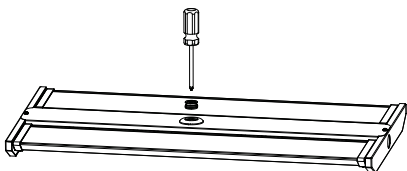

Figure 12

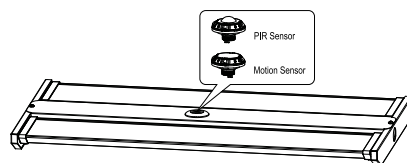

Figure 13