

Linear Highbay: Bolt-Line

3-Power Selectable



Detail Specifications

- Finish: White, Custom finishes available
- IP Rating: Damp Location
- Beam Angle: 110°
- Chip: SMD 2835, R9 >50, CRI >80
- Operating Temperature: -4° - 122° F
- Lens: Clear Prismatic Ribbed
 - Low Glare
- Average life (L70) of 70,000 hours

Applications:

- Warehouse/Distribution Facility
- Utility & Storage
- Garage Structures
- Commercial and Industrial

Product Information:

- Aluminum housing finished with corrosion free power coat
- Replace existing fixtures or use in new construction
- Easy maintenance: driver access from front
- Instant-On to full brightness
- Twist-C Control: Control ready receptacle built into each fixture

Driver Options:

- UNV: 120-277V 0-10V Dimmable
- HV: 347-480V 0-10V Dimmable
- THD: <20% (+/-5% tolerance), PF >0.9, 50/60Hz

Mounting & Installation:

- 3.5' adjustable suspension kit included
- Optional 10 & 20' adjustable suspension kit available
- Optional 6' chain kit available
- Optional surface mount kit available
- Optional pendant mount kit available

Certifications:

- UL Listed for USA and CA
- DLC Premium Listed
- ROHS Compliant
- Approved for CA T24
- 5 Year Limited Warranty
- FCC CFR 47, GCC Part 15, Subpart B:2017



2ft



4ft

WATT	LUMENS
60	8,700
80	11,600
110	15,950
125	18,125
150	21,750
165	23,925
180	26,100
200	29,000
220	31,900
260	37,700
290	42,050
320	46,400

High Bay Luminaires - DLC Product ID:	
LED-LHB-2FT-3P110-F-40K-UNV	PLIWUESBD5IU
LED-LHB-2FT-3P110-F-50K-UNV	PLIWUESBD5IU
LED-LHB-2FT-3P165-F-40K-UNV	PLZM71M24QLR
LED-LHB-2FT-3P165-F-50K-UNV	PLZM71M24QLR

Series	CCT	Voltage ¹	Whip ²	Plug	Optic	EMB
LED-LHB-2FT-3P110-F	40K	UNV	(Blank)	(Blank)	(Blank)	(Blank)
60/80/110W • 120-277V	4000K	120-	No Whip	Hardwire	110°	No
LED-LHB-2FT-3P165-F	50K	277V	-6	SB	Standard	Emergency
125/150/165W • 120-277V	5000K	HV ¹	6ft Whip	5-15P	30D ³	Back-Up
		347-	3-Wire	Straight	30°	EMB
		480V	-10	Blade		90 Min.
			10ft Whip	Plug		Emergency
			3-Wire	TL		Back-up
			-20	L5-15P		
			20ft Whip	Twist		
			3-Wire	Lock		
			-6F	Plug		
			6' Whip			
			5-Wire			
			-10F			
			10' Whip			
			5-Wire			
			-20F			
			20' Whip			
			5-Wire			

1. HV: High voltage is made to order.
 2. 3-wire: for non-dimming or twist-c sensor applications. 5-wire: for 0-10v dimming applications. Emergency models will ship standard with extra emergency wire.
 3. 30D only available on 4ft models

Optional Accessories (Order Separately)					
Suspension Kits	Mounting Kits	Wire Guards	Whips (Field Install)	Sensors ¹	Sensor Remote
SK-10FT-Y-LC-PD 10' Y-Shape, Loop Top, Paddle Bottom (Adjustable Length)	LHB-3P-PDM 165W, 220W, 320W Pendant Mount Kit	LHB-2FT-WG 2ft 110 & 165W	6'-WHIP-1/2KO 6' Whip	S-TWC-PIR -ON/OFF PIR Sensor On/Off Only 5/10/15min	S-LINE-R Remote for S-Line
SK-20FT-Y-LC-PD 20' Y-Shape, Loop Top, Paddle Bottom (Adjustable Length)	LHB-3P-SM 165W, 220W, 320W Surface Mount Kit	LHB-3P-4FT -WG 2ft 220 & 320W	10'-WHIP-1/2KO 10' Whip	S-TWC-PIR-1 PIR Bi-Level Motion + Daylight Sensor (Remote Req'd)	ENVISION CONNECT Bluetooth smart app.
SK-10FT-Y-LC-CB 10' Y-Shape, Loop Top, Carabiner Bottom (Adjustable Length)			20'-WHIP-1/2KO 20' Whip	S-TWC-PIR-SL PIR SILVAIR Bluetooth Mesh + Daylight Sensor	ENVISION CONNECT Download on Apple or Android app store.
SK-20FT-Y-LC-CB 20' Y-Shape, Loop Top, Carabiner Bottom (Adjustable Length)			Custom whips to size available	S-TWC-PIR-BT PIR ENVISIONLS Bluetooth Control	
CK-6FT-V 6' chain hanging kit					

1. Sensor Note:
 Microwave: Detects motion through barriers such as walls, and doors. Ideal for applications where obstacles might obstruct the line of sight. Works effectively outdoors, in large open spaces, & parking lots. Do not use in areas of high vibrations or metal.
 PIR: Ideal for indoor environments with clear lines of sight to the area of interest. Detects warm objects, like a person or animal. Good for high vibration, areas of metal.

Specs and model numbers are subject to change with or without notice.

Linear Highbay: Bolt-Line

3-Power Selectable

FEATURES

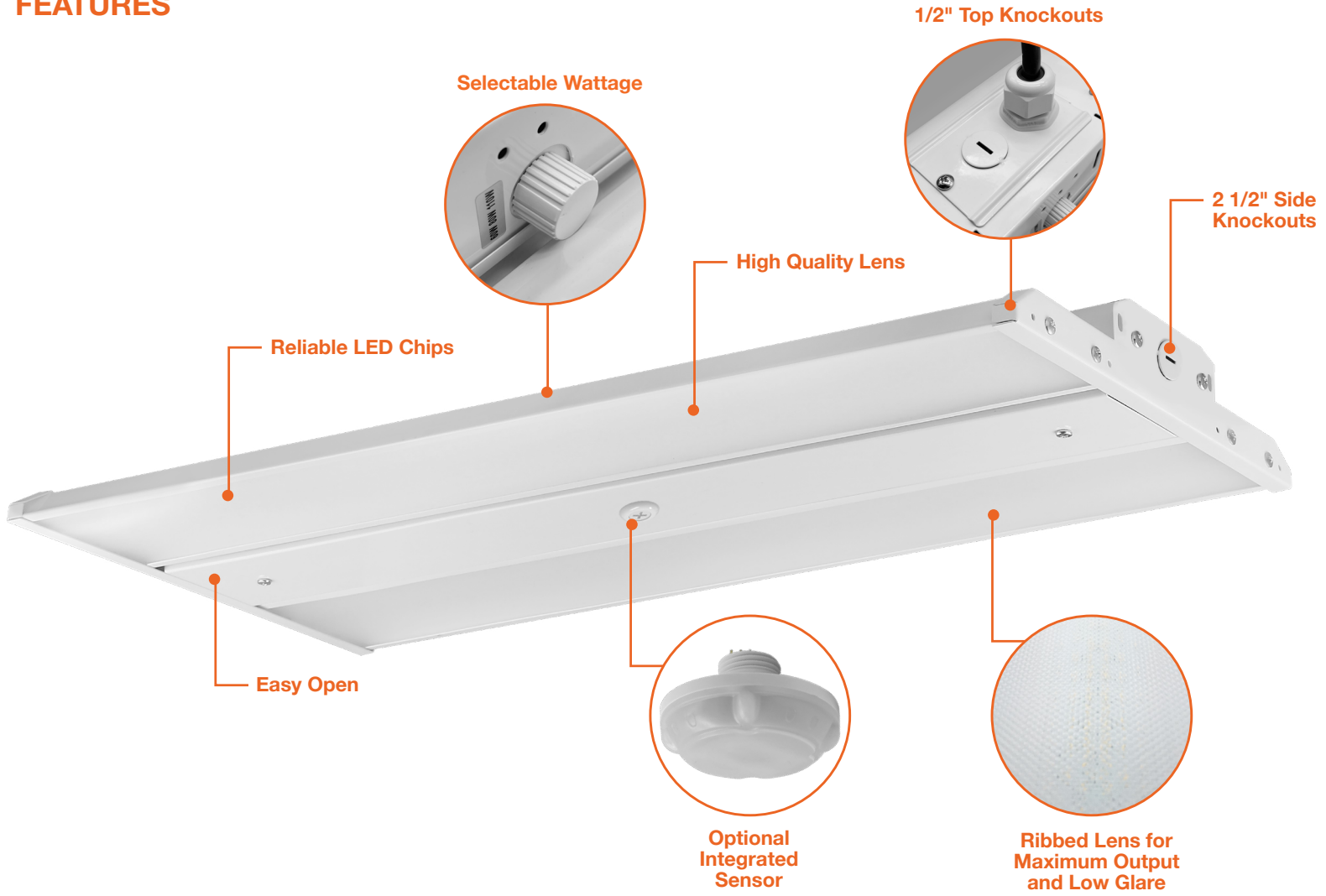

DIMENSIONS

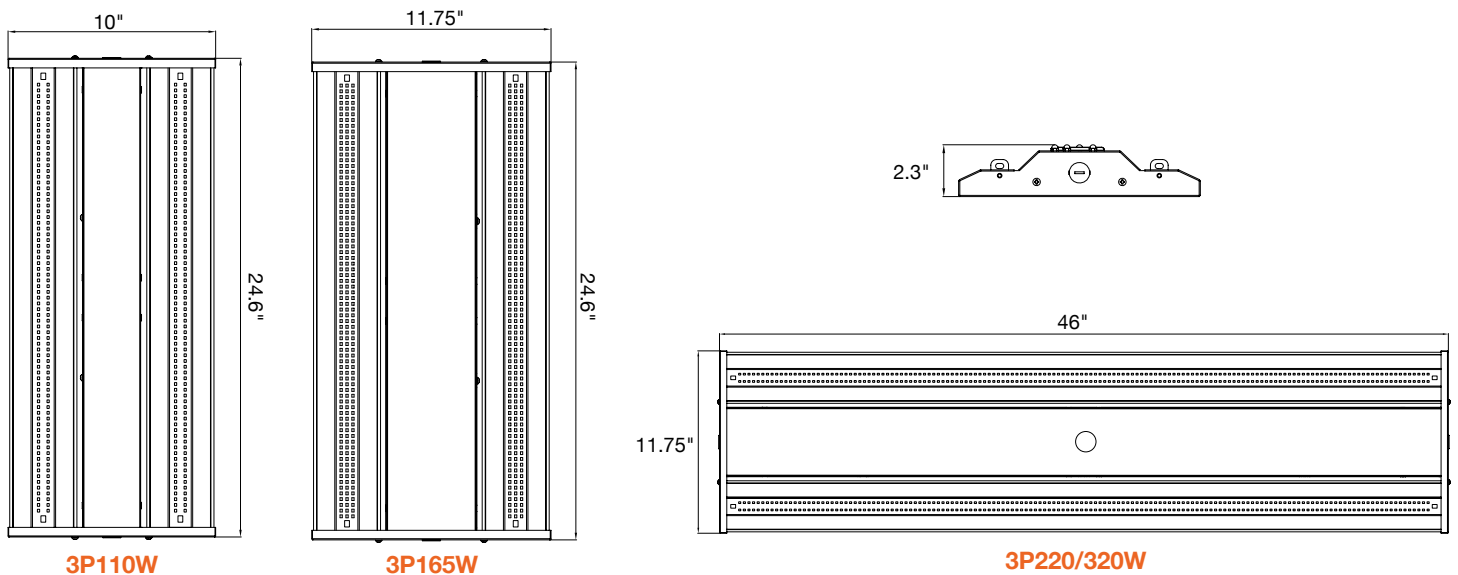

ACCESSORIES



SK-10FT-Y-LC-PD
SK-20FT-Y-LC-PD



SK-10FT-Y-LC-CB
SK-20FT-Y-LC-CB



CK-6FT-V

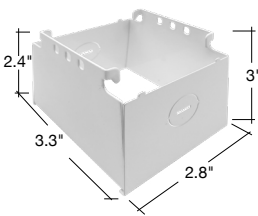

Pendant Mount 2ft
LHB-2FT-3P-PDM
Center Hole Size .85"

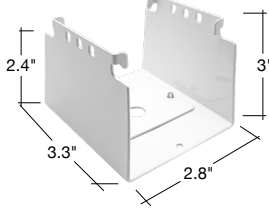

Surface Mount 2ft
(2 Pcs)
LHB-2FT-3P-SM
Center Hole Size 1"
Center Hole Size
w/ Plate .43"

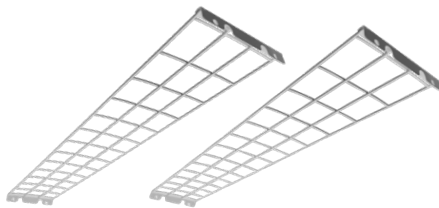

LHB-2FT-WG
LHB-3P-4FT-WG

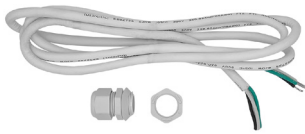

6'-WHIP-1/2KO
10'-WHIP-1/2KO
20'-WHIP-1/2KO



S-TWC-PIR
-ON/OFF



S-TWC-PIR-1
S-TWC-PIR-SL
S-TWC-PIR-BT



S-LINE-R
Controller



SB
5-15P Straight
Blade Plug



TL
L5-15P Twist
Lock Plug

HIGHBAY FIXTURE

Accessory Model	Description
LED-LHB-2FT-3P110-F-40K-UNV	Linear Highbay 2ft 3 Power Select w/ Twist-It Technology
LED-LHB-2FT-3P110-F-50K-UNV	Linear Highbay 2ft 3 Power Select w/ Twist-It Technology
LED-LHB-2FT-3P165-F-40K-UNV	Linear Highbay 2ft 3 Power Select w/ Twist-It Technology
LED-LHB-2FT-3P165-F-50K-UNV	Linear Highbay 2ft 3 Power Select w/ Twist-It Technology
LED-LHB-4FT-3P220W-F-40K-UNV	Linear Highbay 4ft 3 Power Select w/ Twist-It Technology
LED-LHB-4FT-3P220W-F-50K-UNV	Linear Highbay 4ft 3 Power Select w/ Twist-It Technology
LED-LHB-4FT-3P320W-F-40K-UNV	Linear Highbay 4ft 3 Power Select w/ Twist-It Technology
LED-LHB-4FT-3P320W-F-UNV-50K	Linear Highbay 4ft 3 Power Select w/ Twist-It Technology

SUSPENSION KITS

Accessory	Description
SK-10FT-Y-LC-PD	10' Y-Shape, Loop Top, Paddle Bottom (Adjustable Length)
SK-20FT-Y-LC-PD	20' Y-Shape, Loop Top, Paddle Bottom (Adjustable Length)
SK-10FT-Y-LC-CB	10' Y-Shape, Loop Top, Carabiner Bottom (Adjustable Length)
SK-20FT-Y-LC-CB	20' Y-Shape, Loop Top, Carabiner Bottom (Adjustable Length)
CK-6FT-V	6' Chain Hanging Kit

MOUNTING KITS

Accessory Model	Description
LHB-3P-PDM	LHB: Pendant mount bracket up to 320W
LHB-3P-SM	LHB: Surface mount bracket up to 320W

WIRE GUARDS

Accessory Model	Description
LHB-2FT-WG	Linear Highbay Wire Guard 2ft
LHB-3P-4FT-WG	Linear Highbay Wire Guard 4ft

WHIPS (FIELD INSTALL)

Accessory Model	Description
6'-WHIP-1/2KO	6' Whip
10'-WHIP-1/2KO	10' Whip
20'-WHIP-1/2KO	20' Whip

SENSORS

Accessory Model	Description
S-TWC-PIR-ON/OFF	PIR Sensor On/Off Only 5/10/15min
S-TWC-PIR-1	PIR Bi-Level Motion + Daylight Sensor (Remote Req'd)
S-TWC-PIR-SL	PIR SILVAIR Bluetooth Mesh + Daylight Sensor
S-TWC-PIR-BT	PIR ENVISIONLS Bluetooth Control

SENSOR REMOTE









Accessory Model	Description
S-LINE-R	Remote for S-Line Sensor
ENVISION CONNECT	Bluetooth smart app. Download on Apple and Android.

PLUG

Accessory Model	Description
SB	5-15P Straight Blade Plug
TL	L5-15P Twist Lock Plug

Control Options

EnVision LED offers 3 control systems compatible with our LED Fixtures for projects of all sizes and budgets.

	Basic Controls	EnVisionLS 	EnVisionLED.x SILVAIR 
Description	Standard Plug In Sensors	Basic Bluetooth Wireless Control	Advanced Bluetooth Wireless Control
Recommended Quantity (but not limited to)	N/A	>40-50 Nodes	>50 Nodes
Maximum Zone Quantity	N/A	100	3,000
Commissioning Tool	Remote Only	  ENVISIONLS App 	  SILVAIR App 
Commissioning Process	Individually Set via Remote	Wireless Must be done on site	Wireless- Initial linking must be done on site. Commissioning can be done via desktop remotely.
Floor Plan Upload	N/A	N/A	Yes Add a floor plan and mark luminaires & zones via desktop
Gateway	N/A	N/A	Required only for energy monitoring, advanced scheduling, automated demand response.
Individual Luminaire Control	Yes	Yes	Yes
Luminaire Grouping Zoning	N/A	Yes	Yes
High End Power Low End Power	Yes but limited (View Remote)	Yes	Yes
Cost	\$	\$\$	\$\$\$
DLC NLC Listed	N/A	Yes	Yes
Energy Monitoring & Data Reporting	N/A	N/A	Monitor energy usage per individual zone & retrofit cost savings calculation + detailed reporting







Compatible Products:

EnVision offers a variety of nodes, sensors, & gateways that are controlled via remote, ENVISIONLS Bluetooth Mesh & SILVAIR Bluetooth Mesh on all of our 0-10V dimmable fixtures.





Individual Fixture Controls: PIR Sensor, Bi-Level Dimming, Daylight

Basic Note: **-1** • ENVISIONLS Models Note: **-BT** • SILVAIR Models Note: **-SL**

	MODEL #	DESIGN	RECOMMENDED FIXTURE	FEATURES
	S-TWC-PIR-1 S-TWC-PIR-BT S-TWC-PIR-SL	Twist-C Control Sensor	Sensor Ready Fixtures: Area Lights, Canopies, Flood Lights, High Bays	All models are equipped with PIR occupancy sensing, high & low end bi-level dimming, & daylight sensing.
	S-TWC-90 + S-TWC-PIR-1 S-TWC-90 + S-TWC-PIR-BT S-TWC-90 + S-TWC-PIR-SL	Twist-C Control Sensor + 90 Degree Arm	Cylinders, Strips, Wall Packs	
	S-AUD-PIR-1 S-AUD-PIR-BT S-AUD-PIR-SL	2.5m Audio Jack	Panels & Troffers	
	S-SN-PIR-1 S-SN-PIR-BT S-SN-PIR-SL	Snap In Sensor	Troffers & Wraps	

Group Controls ENVISIONLS Models Note : **-BT** • SILVAIR Models Note: **-SL**

	MODEL #	DESIGN	VOLTAGE	FEATURES	RECOMMENDED FEATURES
	S-CM-PIR-LV-BT S-CM-PIR-LV-SL	Ceiling Mounted PIR Sensor	12-24V	PIR Sensor, Bi-Level Dimming, Daylight, 360° detection, 12' Max Mounting Height	Connects to 0-10V dimmable fixtures
	S-WM-PIR-CUNV-BT S-WM-PIR-CUNV-SL	Wall Mounted PIR Occupancy Sensor, Bi-Level Dimming, Daylight	120-277V	On/Off PIR occupancy sensor, 180° detection, 30' detection @ 4' Mounting Height	Connects to LED fixtures
	S-WS-120V-USB-SL		120V	Dimming Wall Socket, Two Sockets	Floor Lamps, Other Lamps

Gateway (Silvair Only) 4.5–5.5 V DC, 2A Power over Ethernet 36–57 V DC

	MODEL #	DESIGN	VOLTAGE	FEATURES	RECOMMENDED FEATURES
	SGW-102	Wall or Ceiling Mounted	POE	Advanced Energy Monitoring Control	Connects to Silvair Controls. Gateway is not required.