

# Slim-Line: 4FT Linear High Bay

## 3-CCT + 5-Power Selectable



### Detail Specifications

- Finish: White
- IP Rating: Damp Location
- Beam Angle: 110°
- Chip: SMD 2835, R9 >50, CRI >80
- Operating Temperature: -4° - 122° F
- Lens: Clear Prismatic Ribbed
  - Low Glare
- Average life (L70) of 70,000 hours

### Applications:

- Warehouse/Distribution Facility
- Utility & Storage
- Garage Structures
- Commercial and Industrial

### Product Information:

- Aluminum housing finished with corrosion free power coat
- Replace existing fixtures or use in new construction
- Easy maintenance: driver access from front
- Instant-On to full brightness
- Twist-C Control: Control ready receptacle built into each fixture
  - Standard Sensors
  - SILVAIR Bluetooth Mesh
  - ENVISIONLS Bluetooth
  - [Click Here](#) for More Information

### Driver Options:

- UNV: 120-277V 0-10V Dimmable
- HV: 347-480V 0-10V Dimmable
- THD: <20% (+/-5% tolerance), PF >0.9, 50/60Hz

### Mounting & Installation:

- 3.5' adjustable suspension kit included
- Optional 10 & 20' adjustable suspension kit available
- Optional 6' chain kit available
- Optional surface mount kit available
- Optional pendant mount kit available

### Certifications:

- UL Listed for USA and CA
- DLC Premium Listed (High Bay Luminaires)
  - Product ID: S-546VDB
- ROHS Compliant
- Approved for CA T24
- 5 Year Limited Warranty
- FCC CFR 47, GCC Part 15, Subpart B:2017

WATT	LUMENS
160	23,200
200	29,000
240	34,800
280	40,600
320	46,400

Series	CCT	Voltage <sup>1</sup>	Whip <sup>2</sup>	Plug	Optic	EMB
<b>LED-LHB-4FT-5P320</b>	<b>CTRI</b>	-	-	-	-	-
160/200/240/280/320W	30/40 50K	<b>UNV</b> 120- 277V 347- 480V	<b>(Blank)</b> No Whip <b>-6</b> 6ft Whip 3-Wire <b>-10</b> 10ft Whip 3-Wire <b>-20</b> 20ft Whip 3-Wire <b>-6F</b> 6' Whip 5-Wire <b>-10F</b> 10' Whip 5-Wire <b>-20F</b> 20' Whip 5-Wire	<b>(Blank)</b> Hardwire <b>SB</b> 5-15P Straight Blade Plug <b>TL</b> L5-15P Twist Lock Plug	<b>(Blank)</b> 110° Standard <b>30D<sup>2</sup></b> 30°	<b>(Blank)</b> No Emergency Back-Up <b>EMB25</b> 25W 90 minute emergency backup <b>EMB40</b> 40W 90 minute emergency backup

1. HV: High voltage is made to order.

2. 3-wire: for non-dimming or twist-c sensor applications. 5-wire: for 0-10v dimming applications. Emergency models will ship standard with extra emergency wire.

### Optional Accessories (Order Separately)

Suspension Kits	Mounting Kits	Wire Guards	Whips (Field Install)	Sensors <sup>1</sup>	Sensor Remote
<b>SK-10FT-Y-LC-PD</b> 10' Y-Shape, Loop Top, Paddle Bottom (Adjustable Length)	<b>LHB-3P-PDM</b> 165W, 220W, 320W Pendant Mount Kit	<b>LHB-3P-4FT-WG</b> 2ft 220 & 320W	<b>6'-WHIP-1/2KO</b> 6' Whip <b>10'-WHIP-1/2KO</b> 10' Whip Custom whips to size available <b>20'-WHIP-1/2KO</b> 20' Whip Custom whips to size available	<b>S-TWC-PIR-ON/OFF</b> PIR Sensor On/Off Only 5/10/15min <b>S-TWC-PIR-1</b> PIR Bi-Level Motion + Daylight Sensor (Remote Req'd) <b>S-TWC-PIR-SL</b> PIR SILVAIR Bluetooth Mesh + Daylight Sensor <b>S-TWC-PIR-BT</b> PIR ENVISIONLS Bluetooth Control	<b>S-LINE-R</b> Remote for S-Line Sensor <b>SILVAIR</b> Bluetooth mesh. Download on Apple or Android app store. <b>ENVISIONLS</b> Bluetooth smart app. Download on Apple or Android app store.
<b>SK-20FT-Y-LC-PD</b> 20' Y-Shape, Loop Top, Paddle Bottom (Adjustable Length)	<b>LHB-3P-SM</b> 165W, 220W, 320W Surface Mount Kit				
<b>SK-10FT-Y-LC-CB</b> 10' Y-Shape, Loop Top, Carabiner Bottom (Adjustable Length)					
<b>SK-20FT-Y-LC-CB</b> 20' Y-Shape, Loop Top, Carabiner Bottom (Adjustable Length)					
<b>CK-6FT-V</b> 6' chain hanging kit					

#### 1. Sensor Note:

Microwave: Detects motion through barriers such as walls, and doors. Ideal for applications where obstacles might obstruct the line of sight. Works effectively outdoors, in large open spaces, & parking lots. Do not use in areas of high vibrations or metal.  
 PIR: Ideal for indoor environments with clear lines of sight to the area of interest. Detects warm objects, like a person or animal. Good for high vibration, areas of metal.

# Slim-Line: 4FT Linear High Bay

3-CCT + 5-Power Selectable

## FEATURES

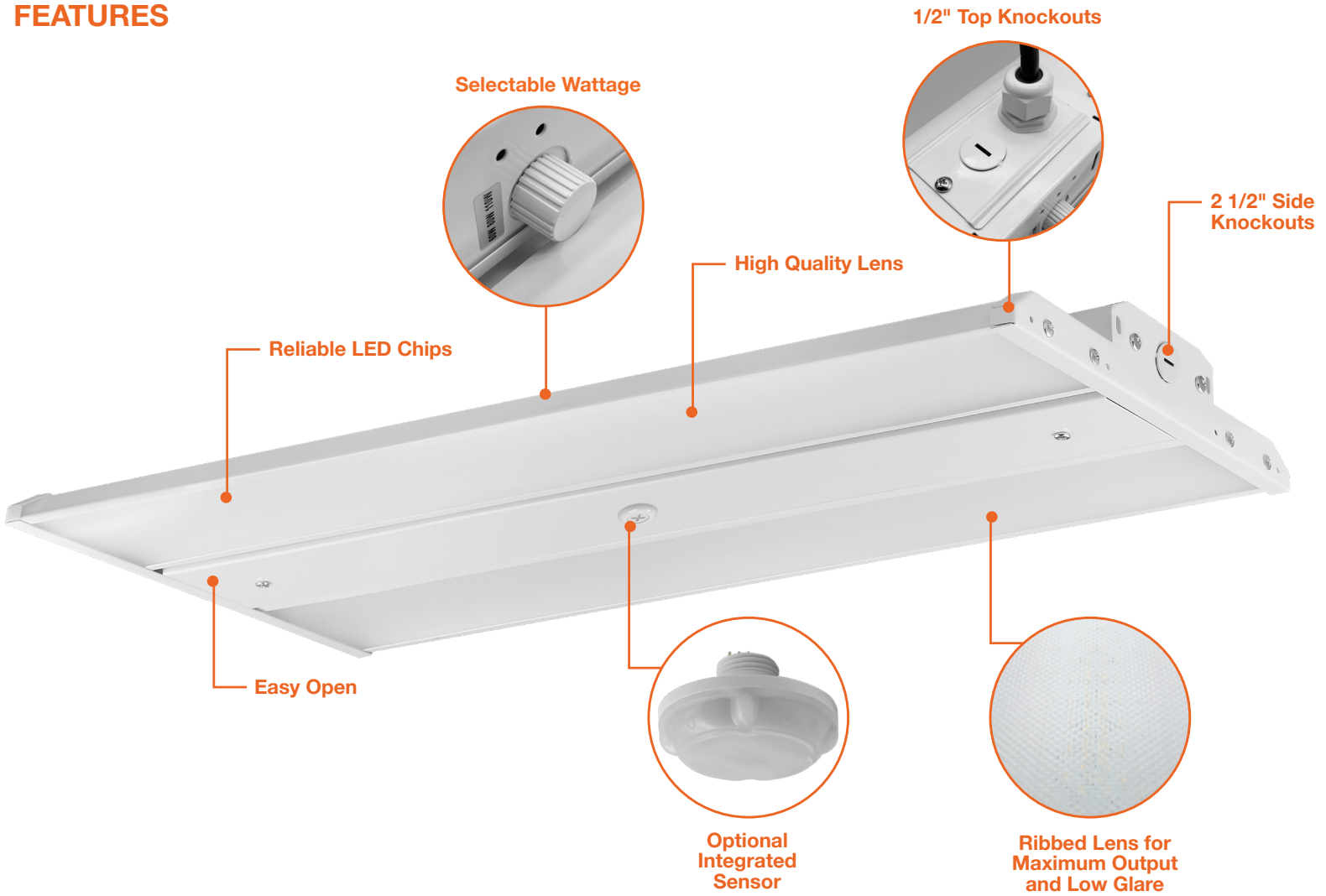

## DIMENSIONS

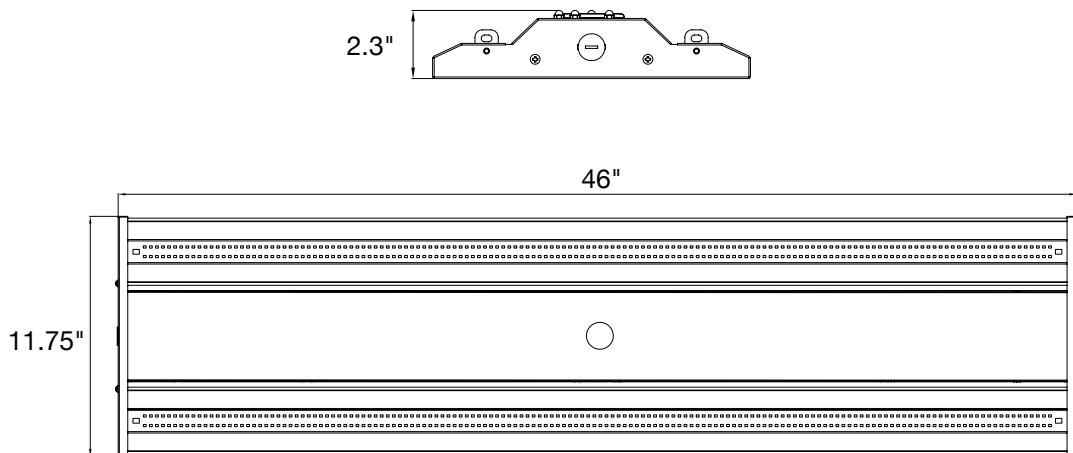

## ACCESSORIES



SK-10FT-Y-LC-PD  
SK-20FT-Y-LC-PD



SK-10FT-Y-LC-CB  
SK-20FT-Y-LC-CB



CK-6FT-V

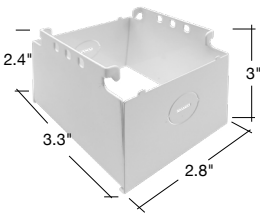

Pendant Mount 2ft  
LHB-2FT-3P-PDM  
Center Hole Size .85"

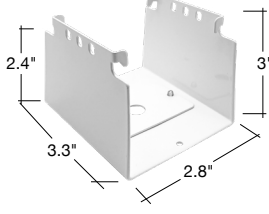

Surface Mount 2ft  
(2 Pcs)  
LHB-2FT-3P-SM  
Center Hole Size 1"  
Center Hole Size  
w/ Plate .43"

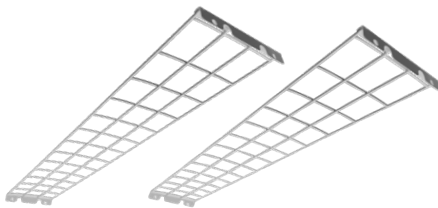

LHB-3P-4FT-WG

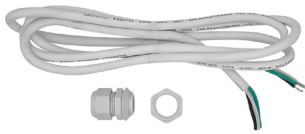

6'-WHIP-1/2KO  
10'-WHIP-1/2KO  
20'-WHIP-1/2KO



S-TWC-PIR  
-ON/OFF



S-TWC-PIR-1  
S-TWC-PIR-SL  
S-TWC-PIR-BT



S-LINE-R  
Controller



SB  
5-15P Straight  
Blade Plug



TL  
L5-15P Twist  
Lock Plug

## HIGHBAY FIXTURE

Model	Voltage	Watts	Lumens	Color
LED-LHB-4FT-5P320-CTRI-UNV	120-277V	320/280/240/200/160w	145lm/w	5000k

## SUSPENSION KITS

Accessory	Description
SK-10FT-Y-LC-PD	10' Y-Shape, Loop Top, Paddle Bottom (Adjustable Length)
SK-20FT-Y-LC-PD	20' Y-Shape, Loop Top, Paddle Bottom (Adjustable Length)
SK-10FT-Y-LC-CB	10' Y-Shape, Loop Top, Carabiner Bottom (Adjustable Length)
SK-20FT-Y-LC-CB	20' Y-Shape, Loop Top, Carabiner Bottom (Adjustable Length)
CK-6FT-V	6' Chain Hanging Kit

## MOUNTING KITS

Accessory Model	Description
LHB-3P-PDM	LHB: Pendant mount bracket up to 320W
LHB-3P-SM	LHB: Surface mount bracket up to 320W

## WIRE GUARDS

Accessory Model	Description
LHB-3P-4FT-WG	Linear Highbay Wire Guard 4ft

## WHIPS (FIELD INSTALL)

Accessory Model	Description
6'-WHIP-1/2KO	6' Whip
10'-WHIP-1/2KO	10' Whip
20'-WHIP-1/2KO	20' Whip

## SENSORS

Accessory Model	Description
S-TWC-PIR-ON/OFF	PIR Sensor On/Off Only 5/10/15min
S-TWC-PIR-1	PIR Bi-Level Motion + Daylight Sensor (Remote Req'd)
S-TWC-PIR-SL	PIR SILVAIR Bluetooth Mesh + Daylight Sensor
S-TWC-PIR-BT	PIR ENVISIONLS Bluetooth Control

## SENSOR REMOTE

Accessory Model	Description
S-LINE-R	Remote for S-Line Sensor
SILVAIR	Bluetooth mesh. Download on Apple or Android app store.
ENVISIONLS	Bluetooth smart app. Download on Apple or Android app store.

## PLUG

Accessory Model	Description
SB	5-15P Straight Blade Plug
TL	L5-15P Twist Lock Plug

# Control Options

EnVision LED offers 3 control systems compatible with our LED Fixtures for projects of all sizes and budgets.

	Basic Controls	EnVisionLS 	EnVisionLED.x SILVAIR 
<b>Description</b>	Standard Plug In Sensors	Basic Bluetooth Wireless Control	Advanced Bluetooth Wireless Control
<b>Recommended Quantity</b> (but not limited to)	N/A	>40-50 Nodes	>50 Nodes
<b>Maximum Zone Quantity</b>	N/A	100	3,000
<b>Commissioning Tool</b>	Remote Only	  ENVISIONLS App 	  SILVAIR App 
<b>Commissioning Process</b>	Individually Set via Remote	Wireless Must be done on site	Wireless- Initial linking must be done on site. Commissioning can be done via desktop remotely.
<b>Floor Plan Upload</b>	N/A	N/A	Yes Add a floor plan and mark luminaires & zones via desktop
<b>Gateway</b>	N/A	N/A	Required only for energy monitoring, advanced scheduling, automated demand response.
<b>Individual Luminaire Control</b>	Yes	Yes	Yes
<b>Luminaire Grouping Zoning</b>	N/A	Yes	Yes
<b>High End Power Low End Power</b>	Yes but limited (View Remote)	Yes	Yes
<b>Cost</b>	\$	\$\$	\$\$\$
<b>DLC NLC Listed</b>	N/A	Yes	Yes
<b>Energy Monitoring &amp; Data Reporting</b>	N/A	N/A	Monitor energy usage per individual zone & retrofit cost savings calculation + detailed reporting







# Compatible Products:

EnVision offers a variety of nodes, sensors, & gateways that are controlled via remote, ENVISIONLS Bluetooth Mesh & SILVAIR Bluetooth Mesh on all of our 0-10V dimmable fixtures.





## Individual Fixture Controls: PIR Sensor, Bi-Level Dimming, Daylight

Basic Note: **-1** • ENVISIONLS Models Note: **-BT** • SILVAIR Models Note: **-SL**

	MODEL #	DESIGN	RECOMMENDED FIXTURE	FEATURES
	<b>S-TWC-PIR-1</b> <b>S-TWC-PIR-BT</b> <b>S-TWC-PIR-SL</b>	Twist-C Control Sensor	Sensor Ready Fixtures: Area Lights, Canopies, Flood Lights, High Bays	All models are equipped with PIR occupancy sensing, high & low end bi-level dimming, & daylight sensing.
	<b>S-TWC-90 + S-TWC-PIR-1</b> <b>S-TWC-90 + S-TWC-PIR-BT</b> <b>S-TWC-90 + S-TWC-PIR-SL</b>	Twist-C Control Sensor + 90 Degree Arm	Cylinders, Strips, Wall Packs	
	<b>S-AUD-PIR-1</b> <b>S-AUD-PIR-BT</b> <b>S-AUD-PIR-SL</b>	2.5m Audio Jack	Panels & Troffers	
	<b>S-SN-PIR-1</b> <b>S-SN-PIR-BT</b> <b>S-SN-PIR-SL</b>	Snap In Sensor	Troffers & Wraps	

## Group Controls ENVISIONLS Models Note : **-BT** • SILVAIR Models Note: **-SL**

	MODEL #	DESIGN	VOLTAGE	FEATURES	RECOMMENDED FEATURES
	<b>S-CM-PIR-LV-BT</b> <b>S-CM-PIR-LV-SL</b>	Ceiling Mounted PIR Sensor	12-24V	PIR Sensor, Bi-Level Dimming, Daylight, 360° detection, 12' Max Mounting Height	Connects to 0-10V dimmable fixtures
	<b>S-WM-PIR-CUNV-BT</b> <b>S-WM-PIR-CUNV-SL</b>	Wall Mounted PIR Occupancy Sensor, Bi-Level Dimming, Daylight	120-277V	On/Off PIR occupancy sensor, 180° detection, 30' detection @ 4' Mounting Height	Connects to LED fixtures
	<b>S-WS-120V-USB-SL</b>		120V	Dimming Wall Socket, Two Sockets	Floor Lamps, Other Lamps

## Gateway (Silvair Only) 4.5–5.5 V DC, 2A Power over Ethernet 36–57 V DC

	MODEL #	DESIGN	VOLTAGE	FEATURES	RECOMMENDED FEATURES
	<b>SGW-102</b>	Wall or Ceiling Mounted	POE	Advanced Energy Monitoring Control	Connects to Silvair Controls. Gateway is not required.