

INSTALLATION INSTRUCTIONS FOR LED BULLET RGB + 5-CCT PATH LIGHTS

LED-PL-21-5W-RGB+5CCT-ALM-BL-LV/LED-PL-21-5W-RGB+5CCT-ALM-BZ-LV

Warning: PLEASE READ AND UNDERSTAND THIS ENTIRE MANUAL BEFORE ATTEMPTING TO ASSEMBLE, OPERATE OR INSTALL THE PRODUCT.

- ONLY use this fixture on 12-24V AC/DC circuits.
- The maximum load (combined total wattage of all fixtures) should NOT exceed 80% of the total power rating of the transformer.
- The wire is intended for shallow burial (less than 6 inches deep).
- Install ALL fixtures at least 10ft away from pools, spas, or fountains.
- Keep the fixtures away from flammable or combustible materials.
- DO NOT touch the lens, guard, or fixture housing while in use.
- DO NOT operate or install a fixture with missing or damaged parts.
- DO NOT submerge this fixture in water as this may damage it.
- Vertically mount the transformer at least 12 inches above the ground.
- Keep this fixture out of the reach of children under 3 years old.
- DO NOT connect this fixture to electrical systems that DO NOT have grounding

PRODUCT DIAGRAM

- A. Shade
- B. Light Bar
- C. Stake
- D. Waterproof wire nuts

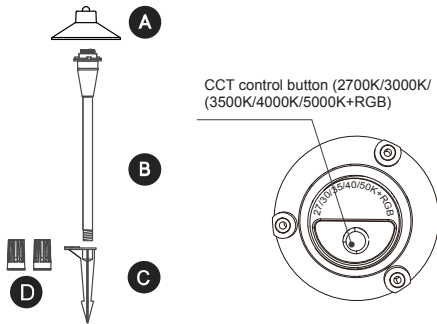

INSTALLATION

Step 1: Prepare a 120V to 12-24 V transformer (not included), a main power cord (not included), waterproof wire nuts and the whole set of light fixtures.

NOTE: The total power of the light fixtures should NOT exceed 80% of the total rating of the transformer. It is recommended to use 12AWG, 14AWG, 16AWG or 18AWG as the main power cord.

Step 2: Turn the power off, and connect the main power cord to the transformer.

Step 3: Move the main power cord to the proper position of the light fixture.

Step 4: Swivel the light bar (B) onto the stake (C) (Fig.1), then put them in the positions you want.

Fig. 1

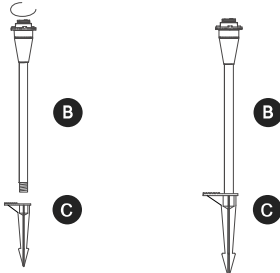

Step 5: Cut the main power cord into two parts and separate the main power cord into two wires from the ends until there is enough length to connect a fixture.

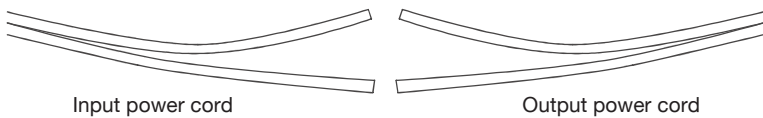

Step 6: Strip approximately 1/2 inches of insulation off the ends.

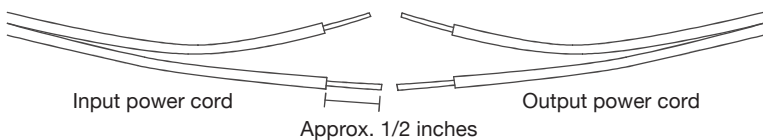

Step 7: Separate the fixture wire into two wires. Connect one input power cord, one output power cord and a fixture wire together through waterproof wire nuts (D) (Fig.2). Fasten the wires tightly together and make sure there isn't a loose wire. Continue to install the rest of the light fixtures by repeating Steps 4 to 7.

NOTE: If using connectors (not included) to install, attach the light fixture wires to the connectors and attach the connector to the main power cord. There is no need to strip the main power cord. If using waterproof wire nuts to install, please follow Steps 5 to 7 to reach the performance.

Fig. 2

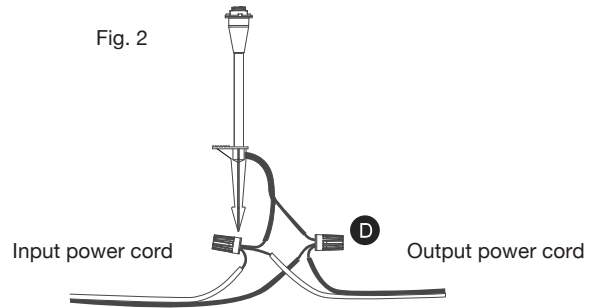

17 SCENE OPTIONS

2700K		RED/GREEN/BLUE		• 2 Second Smooth Color Change
3000K		RED/GREEN/BLUE		• 2 Second Flash Color Change
3500K		ALL COLORS		• 2 Second Smooth Color Change
4000K		ALL COLORS		• 2 Second Flash Color Change
5000K		ALL COLORS		• 2 Second Smooth Color Change + 2 Second Flash Color Change
WHITE		OFF		
RED				
GREEN				
BLUE				
ORANGE				
PURPLE				
CYAN				

Fig. 3

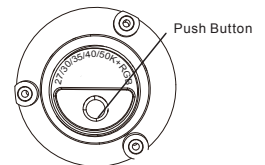

Step 9: Turn the power off again. Use a shovel to loosen the ground or soften it with water, then insert the fixture into the ground. And place the wires inside the dug ditch, then cover the wires the surrounding dirt.

NOTE: DO NOT use a hammer. DO NOT attempt to use your weight to push the fixture into the ground. If your layout requires shorter distances between fixtures, roll up and bury the excess wire. Step 10: Swivel the shade (A) onto the light bar (B), and turn on the power to check again. Then finish the installation. (Fig4)

Fig. 4

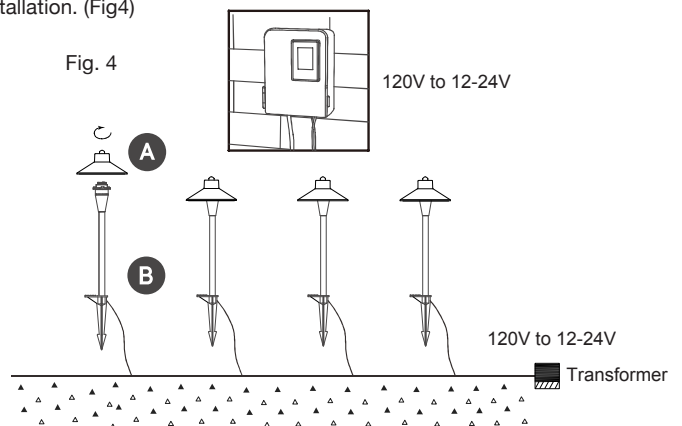

CARE AND MAINTENANCE

- Before attempting to clean the fixture, disconnect the power by turning off the breaker or by removing the fuse from the box.
- DO NOT USE ANY CLEANERS WITH CHEMICALS, SOLVENTS OR HARSH ABRASIVES.

TROUBLESHOOTING

If all light are not working properly:

- Check if the power is turned on.
- Check to make sure the input voltage is 12-24V.
- Check to make sure that the transformer is properly connected.

If some lights are not working properly:

- Check the wiring, make sure that all connections between the lights and the main power cord are tightened properly.
 - Check the connectors, if any, make sure that connectors work correctly.
- If the lights still do not work after several adjustments, please contact our customer service as soon as possible.