

RHB3 UFO High Bay: C-Line

3-CCT + 3-Power Selectable

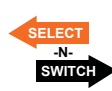

Detail Specifications:

- Finish: Black or White
- IP Rating: Wet Location
- Beam Angle: 110°
- Chip: SMD 2835, R9 >50, CRI >80
- Operating Temperature: -40° - 113° F
- Lens: Clear Acrylic
- Average life (L70) of 70,000 hours

Applications:

- Warehouse/Distribution Facility
- Utility & Storage
- Garage Structures
- Commercial and Industrial

Product Information:

- Sturdy die-cast aluminum housing finished with corrosion free powder coat
- Compact design for easy installation
- Replace existing fixtures or use in new construction
- Instant-On to full brightness
- Select-n-Switch Technology: 3-CCT + 3-Power Selectable
- Twist-C Control: Control ready receptacle built into each fixture

Driver Options:

- UNV: 120-277V 0-10V Dimmable
- HV: 2777-480V 0-10V Dimmable
- THD: <20% (+/-5% tolerance), PF >0.9, 50/60Hz
- Flicker Free

Mounting & Installations:

- 10' whip included
- Clip on eye hook included with each fixture
- Optional pendant mount for 1/2" pipe available
- Optional surface mount kits available

Certifications:

- UL Listed for USA and CA
- DLC Listed
- NSF Listed
- ROHS Compliant
- Approved for CA T24
- 5 Year Limited Warranty
- FCC CFR 47, GCC Part 15, Subpart B:2017

WATT	LUMENS
60	9,000
100	15,000
150	22,500
180	27,000
210	31,500
240	36,000

Series	Finish	Whip	Voltage	EMB	Surge Protector
LED-RHB3C-3P150-CTRI 60/100/150W 35/40/50K	BL Black	10 10' Whip (Incl.)	UNV 120-277V HV 277-480V	(Blank) No Emergency Backup EMB 90 Minute Emergency Backup	(Blank) 6KV Built In 20KV Surge Protector
LED-RHB3C-3P240-CTRI 180/210/240W 35/40/50K	WH White	CS Extend to Custom Length			

Optional Accessories (Order Separately)

Sensors 1	Remote Sensors	Reflector 2	Reflector Bottom 2	Wire Guards	Mounting Kits 3	Emergency Backup
HB01DMS-A Bi-Level Motion + Daylight Sensor S-TWC-MW-1 Microwave Bi-Level Motion + Daylight Sensor (Remote Req'd) S-TWC-PIR-1 PIR Bi-Level Motion + Daylight Sensor (Remote Req'd) S-TWC-MW-BT Bluetooth Microwave Bi-Level Motion + Daylight Sensor S-TWC-PIR-BT PIR Microwave Bi-Level Motion + Daylight Sensor	HB03R Remote for HB01DMS S-LINE-R Remote for S-Line Sensor ENVISION CONNECT Bluetooth smart app. Download on Apple or Android app store.	RHB3-100/150 -ALM-RF-90 Aluminum Reflector for 100 & 150W RHB3-240-ALM -RF-90 Aluminum Reflector for 240W -ACR-RF 90° Acrylic Reflector for 100 & 150W RHB3-240-ACR -RF 90° Acrylic Reflector for 240W	RHB3-UNV-ACR -BC Only Works with Acrylic Lens RHB3-100/150 -WG Wire Guard for 100 & 150W RHB3-240-WG Wire Guard for 240W	RHB-100/150 -SM Surface Mount Kit for 100 & 150W RHB-240-SM Surface Mount Kit for 240W RHB-PDM-HK 1/2" Pip Pendant Mount SK-10FT-Y-LC -CB Suspension Kit: 10' Y-Shape, Loop Top, Carabiner Bottom (Adjustable Length) SK-20FT-Y-LC -CB Suspension Kit: 20' Y-Shape, Loop Top, Carabiner Bottom (Adjustable Length)	LED-EMB-30W -HV-UFO-BL Pendant Emergency Backup (Black) LED-EMB-30W -HV-UFO-WH Pendant Emergency Backup (White) UFO-TEST -CTR Test Button Controller	

1. Sensor Note:
 Microwave: Detects motion through barriers such as walls, and doors. Ideal for applications where obstacles might obstruct the line of sight. Works effectively outdoors, in large open spaces, & parking lots. Do not use in areas of high vibrations or metal.
 PIR: Ideal for indoor environments with clear lines of sight to the area of interest. Detects warm objects, like a person or animal. Good for high vibration, areas of metal.

2. Reflectors and wire guards can't be mixed together. i.e. if fixture uses a reflector, it wont work with a wire guard.

3. Custom emergency backup option available in surface mount applications. Contact us for more information.

RHB3 UFO High Bay: C-Line

3-CCT + 3-Power Selectable

FEATURES



3-Power Selectable



3-CCT Selectable

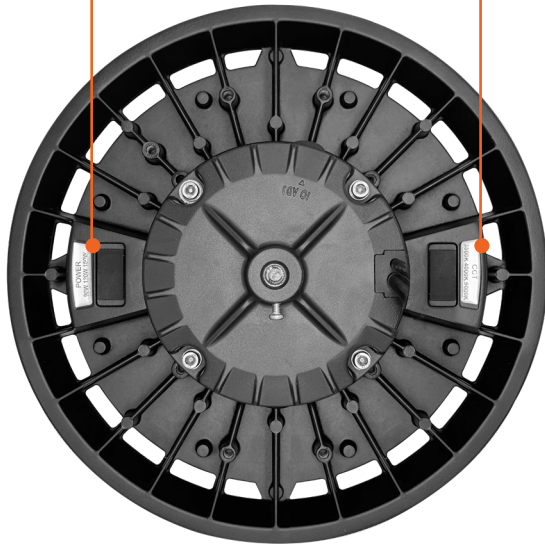

RHB3 UFO High Bay: C-Line

3-CCT + 3-Power Selectable

DIMENSIONS

Pendant Mount

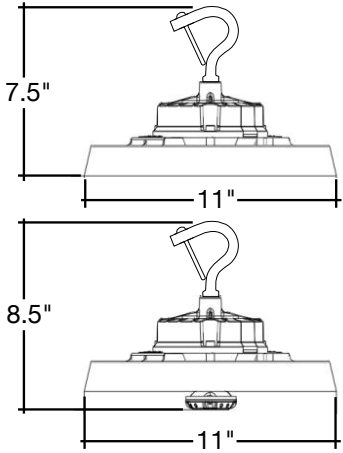

3P150W

Surface Mount

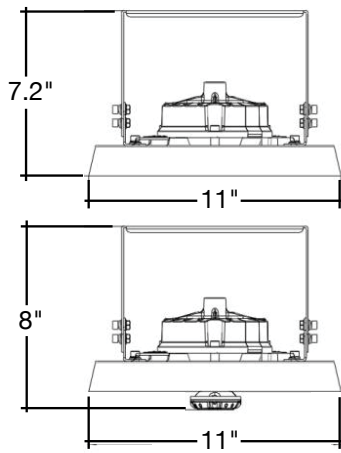

Pendant Mount

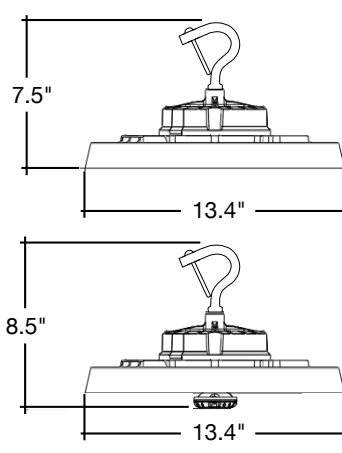

3P240W

Surface Mount

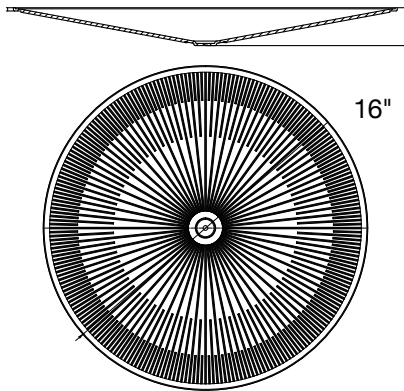
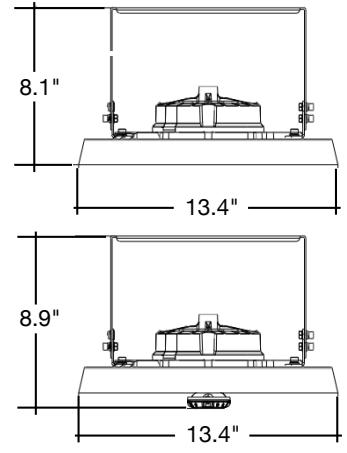

Acrylic Bottom Cover (90°)

RHB3-UNV-ACR-BC

Only Compatible with ACR Reflectors

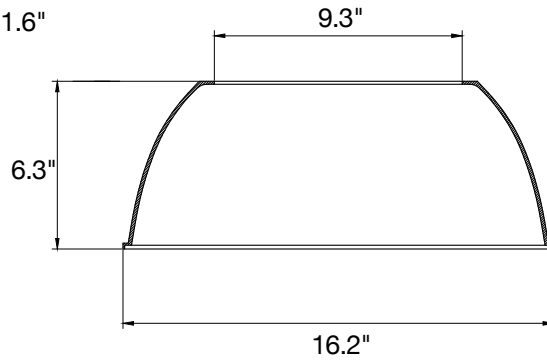

Acrylic Reflector (90°)

RHB3-100/150-ACR-RF

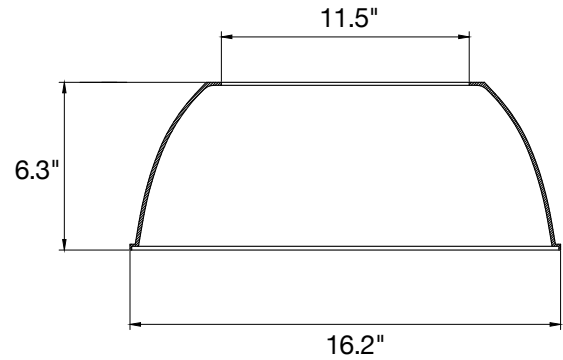

Acrylic Reflector (90°)

RHB3-240-ACR-RF

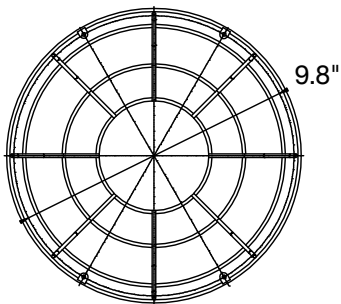

Wire Guard

RHB3-100/150-WG

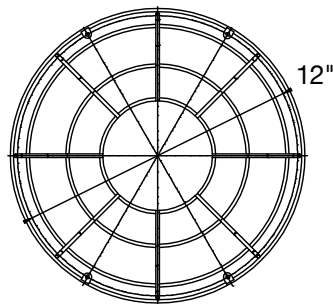
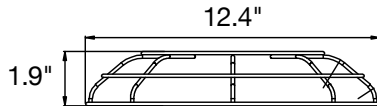

Wire Guard

RHB3-240-WG

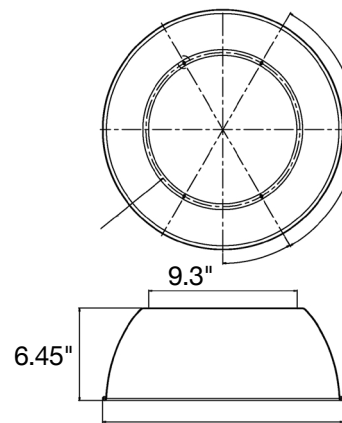

Aluminum Reflector

RHB3-100/150-ALM-RF-90

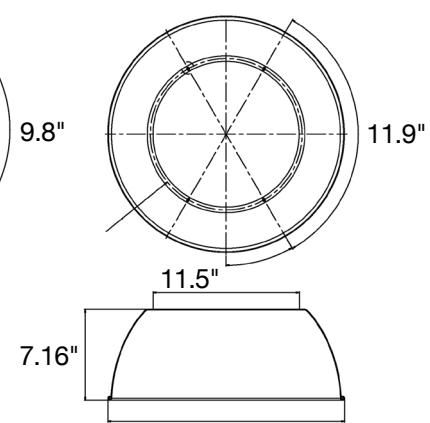

Aluminum Reflector

RHB3-240-ALM-RF-90



RHB3-100/150-ALM-RF-90
or
RHB3-240-ALM-RF-90



RHB3-100/150-ACR-RF
or
RHB3-240-ACR-RF



RHB3-100/150-ACR-RF
or
RHB3-240-ACR-RF
+
RHB3-UNV-ACR-BC



Acrylic Reflector
Bottom Cover & Sensor



RHB3-100/150-WG
or
RHB3-240-WG



RHB-100/150-SM
RHB-240-SM



SK-10FT-Y-LC-CB
SK-20FT-Y-LC-CB



RHB-PDM-HK



LED-EMB-30W-HV-UFO-BL
LED-EMB-30W-HV-UFO-WH



UFO-TEST-CTR



HB03R



S-LINE-R



HB01DMS-A



S-TWC-MW-1
S-TWC-MW-BT



S-TWC-PIR-1

REFLECTORS

Accessory Model	Description
RHB3-100/150-ALM-RF	90° Aluminum reflector for 100 & 150W
RHB3-240-ALM-RF	90° Aluminum reflector for 240W
RHB3-100/150-ACR-RF	90° Acrylic reflector for 100 & 150W
RHB3-240-ACR-RF	90° Acrylic reflector for 240W

REFLECTOR BOTTOM COVERS

Accessory Model	Description
RHB3-UNV-ACR-BC	Acrylic Bottom Cover 90° (Only acceptable with Acrylic Lens)

WIRE GUARDS

Accessory Model	Description
RHB3-100/150-WG	Wire guard for 100 & 150W
RHB3-240-WG	Wire guard for 240W

MOUNTING KITS

Accessory Model	Description
RHB-PDM-HK	Pendant Mount Hook 1" Pipe
RHB-100/150-SM	100/150w Surface Mount
RHB-240-SM	240w Surface Mount
SK-10FT-Y-LC-CB	Suspension Kit: 10' Y-Shape, Loop Top, Carabiner Bottom (Adjustable Length)
SK-20FT-Y-LC-CB	Suspension Kit: 20' Y-Shape, Loop Top, Carabiner Bottom (Adjustable Length)

EMERGENCY BACKUP

Accessory Model	Description
LED-EMB-30W-HV-UFO-BL	Emergency Back Up For Internal Drivers- High Voltage 170V Output - Includes Round UFO HighBay EM Kit (Black)
LED-EMB-30W-HV-UFO-WH	Emergency Back Up For Internal Drivers- High Voltage 170V Output - Includes Round UFO HighBay EM Kit (White)
UFO-TEST-CTR	Test Button Controller

REMOTE CONTROL

Accessory Model	Description
HB03R	Remote for HB-Line Series
S-LINE-R	Remote for S-LINE Series Sensors

SENSOR

Accessory Model	Description
HB01DMS-A	A Default Setting • BRIGHTNESS: 100% • HOLD TIME: 1Min. Stand-By Dimming Level: 20% • Stand-By Time: 1 Min. SENSITIVITY: 100% • DAYLIGHT: DISABLE
S-TWC-MW-1	"Twist-C Microwave Sensor • BRIGHTNESS: 100%/ HOLD TIME: 10MIN. • BI-LEVEL DIM: 50% STAND BY TIME: 1 MIN SENSITIVITY: 100% DAYLIGHT: ENABLED"
S-TWC-PIR-1	"Twist-C Microwave Sensor • BRIGHTNESS: 100%/ HOLD TIME: 10MIN. • BI-LEVEL DIM: 50% STAND BY TIME: 1 MIN SENSITIVITY: 100% DAYLIGHT: ENABLED"
S-TWC-MW-BT	"Twist-C Microwave Sensor • BRIGHTNESS: 100%/ HOLD TIME: 10MIN. • BI-LEVEL DIM: 50% STAND BY TIME: 1 MIN SENSITIVITY: 100% DAYLIGHT: ENABLED"
ENVISION CONNECT	Bluetooth smart app. Download on Apple or Android app store.