

LED Strip Installation Instructions

Cautions

1. Can not use the electric generator to test the LED light.
2. Please abide by related country, regional and local law and regulations when install this fixture.
3. Please turn off the power before installation or maintenance.
4. Proper earth grounding is required to ensure safety.

Notice

1. To avoid possibility of electrical shock or fire, the installation personnel must have professional electric knowledge.
2. Please wear gloves to avoid injury before installation.
3. If any smoke or spark of the wire happened, please turn off the power immediately and notify relevant personnel.

Attention

1. Please check if there is any damage during shipping. If so, please contact manufacturer timely.
2. Please read the installation instruction carefully to check whether all the accessories are complete. After confirmation, then install the fixture according to installation steps.

Wiring Diagram & Instruction

3 dimming functions are available in this high bay light

1. Constant current can be achieved by 0/1-10VDC dimming
2. PWM signal dimming
3. Variation of resistance unit dimming.

Description:	
This product is 0/1-10V dimming, below dimmers are recommended:	
Brand	Model
LUTON	NTSTV-DV
LEVITON	DS710-10Z / IP710
LEGRAND	RH4FBL3PW

Wiring Instruction

L: Black
N: White
⊕ : Green/Yellow

DIM +
DIM -

(As for the wire color of DIM+ and DIM-, pls check the light label.)

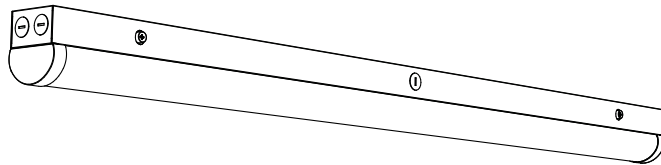

Please choose the appropriate dimming way according to your needs. You can also choose not to use this function.

Round lampshade or square lampshade will not affect the installation method or function expansion of the product.

CCT or Wattage Tunable

Step 1. Press the screws on both sides of the lamp by hand to open the lamp, Wattage can be adjusted via dialing.

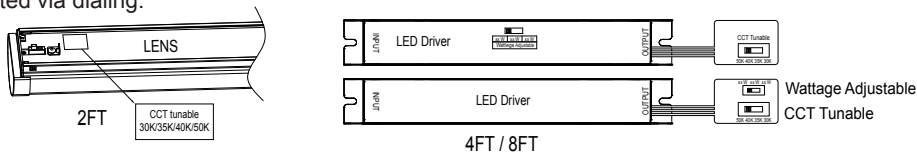

Two installation methods: A Surface Mounting, B Hanging
(Please choose the most suitable installation method for the purchased product as per your needs.)

A. Surface Mounting

- Step 1. According to the different lengths of the product, drill holes at the corresponding positions and drive the rubber plugs from the accessory kit into the holes (Figure 1)
- Step 2. Clamp the disc from the accessory kit to the lamp (this step can be omitted if the light fixture can completely cover the junction box on the wall) (figure 2)
- Step 3. Press the screws on both sides of the lamp by hand to open the lamp (Figure 3)
- Step 4. Lead the wire into the lamp and install the lamp chassis by using the screws in the accessory kit (figure 4)
- Step 5. Connect the wires according to safety requirements, and then install the lamp body back to the chassis. By using an extra mounting bracket, the lights can be connected in series (Figure 5) (Product connection: 20W lamps can be connected to maximum 50pcs, 40W 20pcs, and 60W 12pcs, and 100W 6pcs)

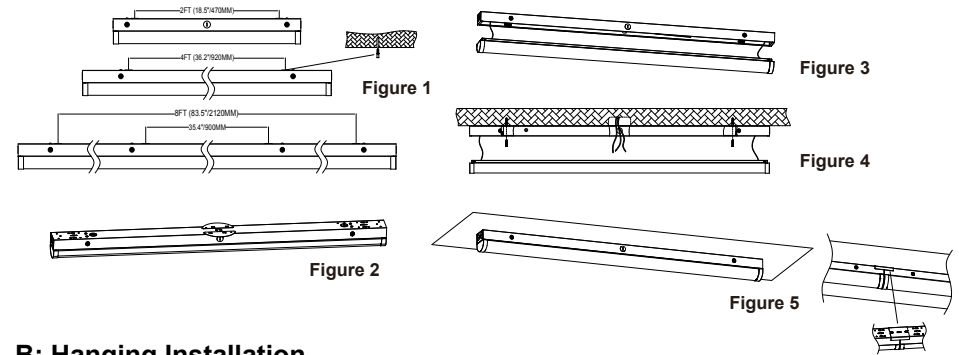

B: Hanging Installation

- Step 1. Hang one end of the installation rope in the accessory kit on the wall or hook (Choose accessories according to your needs) (Figure 6)
- Step 2. Fasten the other end of the installation rope to the lamp (Figure 7)
- Step 3. Press the screws on both sides of the lamp by hand to open the lamp.
- Step 4. Connect the wires according to safety requirements, and then install the lamp body back to the chassis (Figure 8)

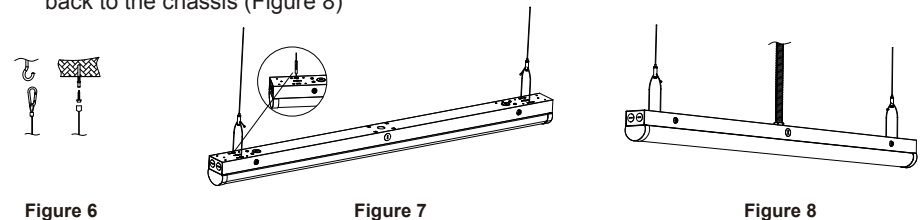

Extra Accessory Option Installation: 1: Product lengthening, 2: Sensor, 3: Backup driver, 4: Wire Guard.

1. Product lengthening

- Step 1. Use the screws in the accessory kit to lock the bracket onto one lamp (figure 9)
- Step 2. Align the other lamp to the bracket and lock the screws (Figure 10)
(Product connection: 20W lamps can be connected to maximum 50pcs, 40W 20pcs, and 60W 12pcs, and 100W 6pcs).

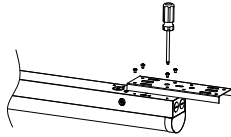

Figure 9

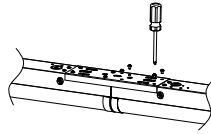

Figure 10

2-1. AC PIR Sensor

Step 1. Press the screws on both sides of the lamp by hand to open the lamp.

Step 2. Assemble the PIR sensor onto the lamp (Figure 11), connect the wires according to the wiring instructions, and then assemble the disassembled lamp back. (Figure 12)

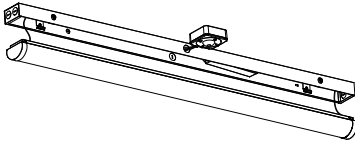

Figure 11

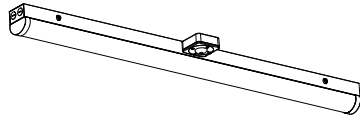

Figure 12

2-2. DC Motion Sensor

Step 1. Press the screws on both sides of the lamp by hand to open the lamp.

Step 2. Assemble the DC sensor to the corresponding position (Figure 13).

Step 3. Connect the wires according to the wiring instructions, adjust sensing mode as per demand, and then assemble the disassembled lamp back. (Figure 14)

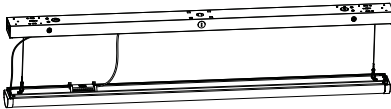

Figure 13

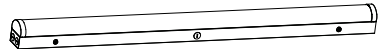

Figure 14

3. Backup driver

Step 1. Press the screws on both sides of the lamp by hand to open the lamp.

Step 2. Assemble the backup driver to the lamp chassis (Figure 15)

Step 3. Connect the wires according to the wiring instructions, and assemble the disassembled lamp back. (Figure 16)

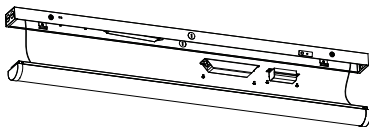

Figure 15

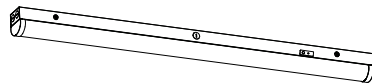

Figure 16

4. Wire Guard

After installing the product is completed, install the barbed wire on the lamp with screw. (Figure 17/18)

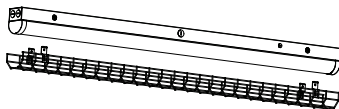

Figure 17

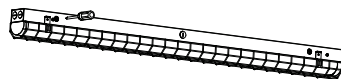

Figure 18