

7" Surface Mount Installation Instructions



INSTRUCTIONS PERTAINING TO RISK OF FIRE OR INJURY TO PEOPLE
READ ALL INSTRUCTIONS

IMPORTANT SAFETY INSTRUCTIONS
SAVE THESE INSTRUCTIONS

TOOLS AND MATERIALS REQUIRED



Philips
Screwdriver



Wire Cutters

Wiring supplies
as required by
Electrical Code
and/or the
Quebec
Electrical Code



Pliers



Wrench

Safety Precautions:

1. TURN OFF ELECTRICAL POWER BEFORE STARTING INSTALLATION OF LIGHT FIXTURE.
2. THIS PRODUCT MUST BE INSTALLED IN ACCORDANCE WITH THE APPLICABLE INSTALLATION CODE BY A PERSON FAMILIAR WITH THE CONSTRUCTION AND OPERATION OF THE PRODUCT AND THE HAZARDS INVOLVED.
3. CAUTION RISK OF FIRE - CONSULT A QUALIFIED ELECTRICIAN TO ENSURE CORRECT BRANCH CIRCUIT CONDUCTOR.
4. FOR EXTERNAL USE ONLY, RECOMMEND APPLYING WATERPROOF SILICONE TO SEAL AROUND TRIM AND CEILING.

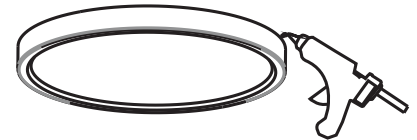

PACKAGE CONTENTS

PART	DESCRIPTION	QTY.	NOTE
A	Slim flush mount light	1	
B	Mounting Screws	2	
C	Wire Nut	3	
D	Springs	3	
E	Mounting Plate	1	
F	E26 Lamp Holder	1	

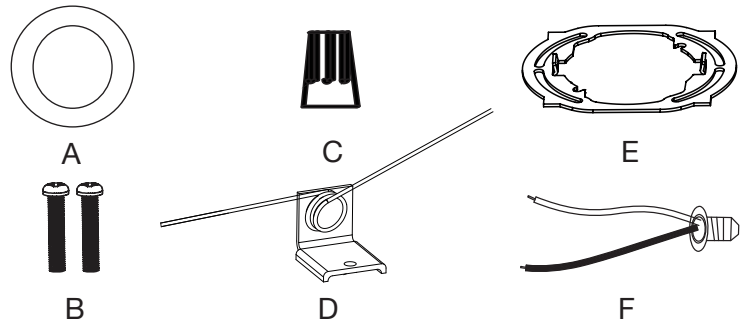

OPTION #1: FLUSH MOUNT

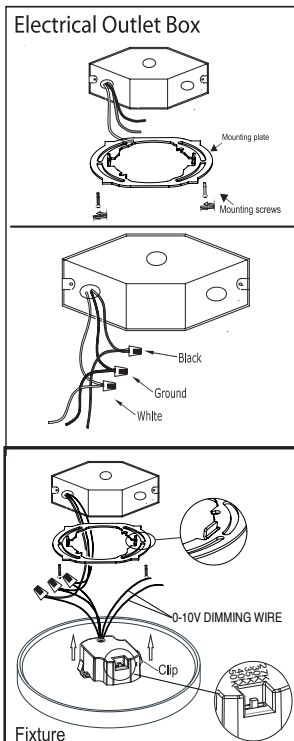

1. Prior to installation, install mounting plate into the electrical outlet box with mounting screws. Drive screws completely to the end of the junction box.
2. Connect supply wires to wires on fixture with wire nuts or push wires into Quick Connector. Connect white to white, black to black, and copper wire to copper wire as grounding connection.
3. Completing the installation by pushing the fixture into the mounting plate. For 0-10V dimming circuits, connect grey to grey and purple to purple

Option #2: RETROFIT A RECESSED CAN

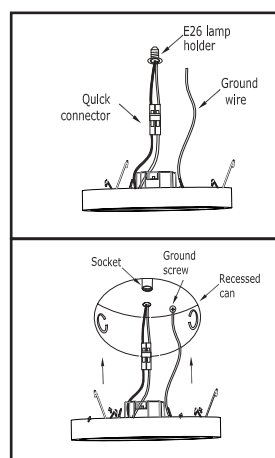

Insert wires into Quick connector. Black to black and white to white. Attach ground wire to ground screw in recessed can.

Turn E26 lamp holder into socket base.

Connect Quick Connectors
Tuck all wires into recessed can.
Squeeze springs and push up into recessed can.

