

Full-Line: Traditional Wall Pack

3-CCT + 5-Power Selectable

Wall Packs



Detail Specifications:

- Finish: Bronze, Black, White, Custom finishes available
- IP Rating: Wet Location
- Impact Rating: IK08
- Beam Angle: Type IV
- BUG: B3-U5-G5
- Chip: SMD 2835, R9 >50, CRI >80
- Operating Temperature: -40° - 122° F
- Lens: Glass Lens
- Average life (L70) of 70,000 hours

Applications:

- Walkways & Pathways
- Parking Lots
- Hospitality, Multi-Family
- Outdoor Corridors
- Residential, Commercial and Industrial

Product Information:

- Sturdy die-cast aluminum housing finished with corrosion free powder coat
- Traditional metal-halide wall pack size
- Photocell is included with an easy quick disconnect
- Instant-On to full brightness
- Select-n-Switch Technology: 3-CCT + 3-Power Selectable
- Control Options:
 - Standard Sensors
 - SILVAIR Bluetooth Mesh
 - ENVISIONLS Bluetooth
 - [Click Here](#) for More Information

Driver Options:

- UNV: 120-277V 0-10V Dimmable
- HV: 277-480V 0-10V Dimmable
- Built in 6Kv Surge Protector
- THD: <20% (+/-5% tolerance), PF >0.9, 50/60Hz

Mounting & Installation:

- Five 1/2" knockouts: 1 one each side for convenient installation

Certifications:

- UL Listed for USA and CA
- DLC Premium Listed
 - 5P60: S-3F4U58
 - 5P120: S-X10LPR
- ROHS Compliant
- Approved for CA T24
- 5 Year Limited Warranty
- FCC CFR 47, GCC Part 15, Subpart B:2017

5P60		5P120	
WATT	LUMENS	WATT	LUMENS
20	2,300	40	5,600
30	4,200	60	8,400
40	5,600	80	11,200
50	7,000	100	14,000
60	8,400	120	16,800

Series	Wattage	Color Temp	Finish	Photocell	Voltage	Sensor 2	Emergency	Surge Protector
LED-WPF -		TRI		PC				
Wall Pack:	5P60	30/40	BZ	Photocell is included.	(Blank)	(Blank)	(Blank)	(Blank)
Full Line	20/30	50K	Bronze (Standard)	Easy quick disconnect.	120-277V	No Sensor	No Emergency	6KV Built In
	40/50		BL	(PC-3/4-	HV	BMS	EMB	20KV
	60W		Black	3PIN-LV)	277-480V	Bi-Level Motion + Daylight Sensor Remote Required: (S-LINE-R)	90 Minute Emergency Backup	20KV Surge Protector
	5P120		WH				30-120F	
	40/60		White				CEMB	
	80/100		GRY ¹				90 Minute Emergency Backup	
	120W		Gray				Cold Weather -4-120F	
			CS ¹					
			Custom Color					
						BMS-BT		
						PIR ENVISIONLS Bluetooth Control		
						BMS-SL		
						PIR SILVAIR Bluetooth Mesh		

1. Standard quickship is bronze, black, & white. Other colors are custom finishes.

2. Sensors require remote for programming

Optional Accessories (Order Separately)	
Wire Guard	Shield
WPF-WG	WPF-SHIELD
Wire Guard	Shield

Specs and model numbers are subject to change with or without notice.

Full-Line: Traditional Wall Pack

3-CCT + 5-Power Selectable

FEATURES

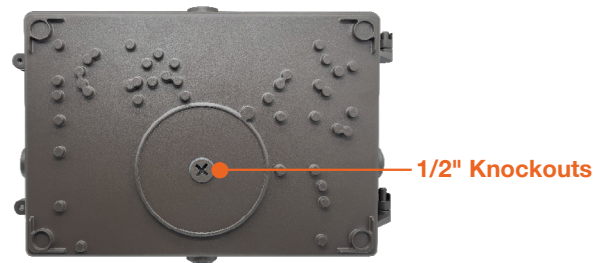
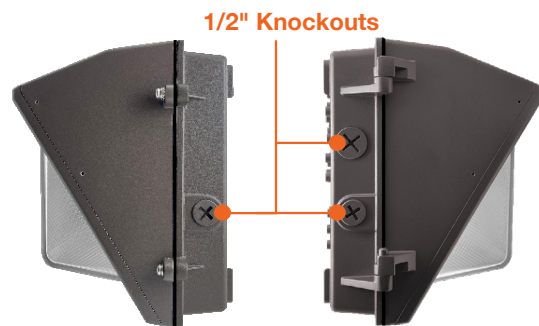
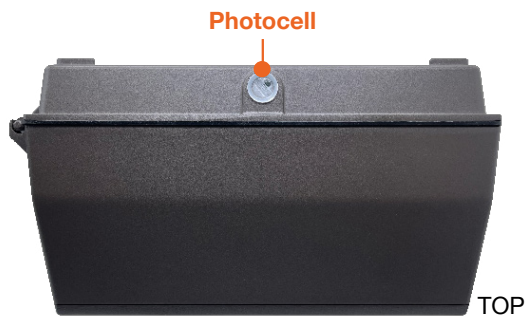

DIMENSIONS

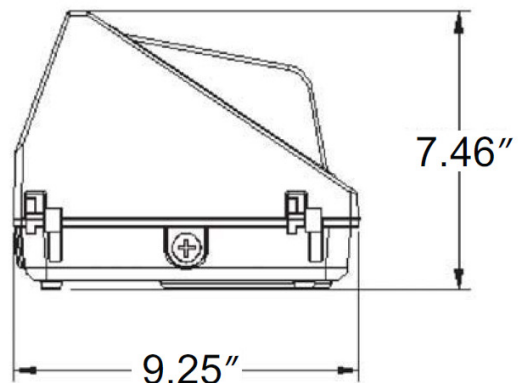
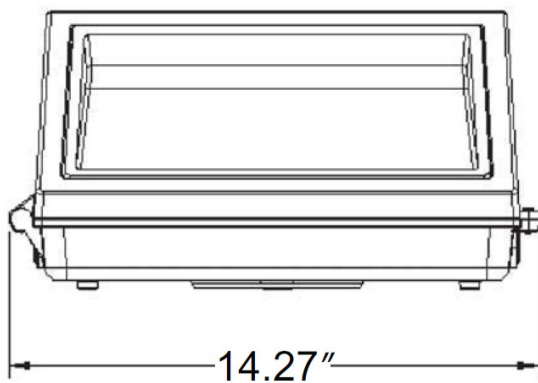

Full-Line: Traditional Wall Pack

3-CCT + 5-Power Selectable

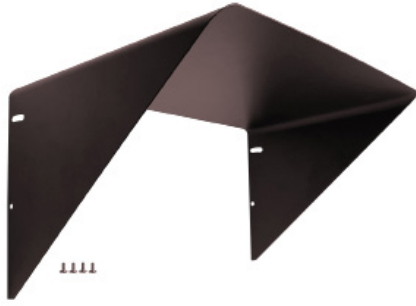

WPF-SHIELD

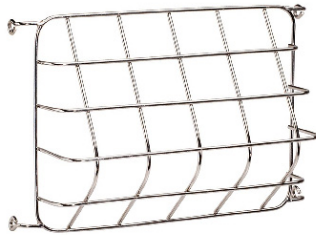

WPF-WG

WALL PACK

Model	Voltage	Watts	Lumens	Color	CRI
LED-WPF-5P60-TRI-BZ-PC	120/277V	20/30/40/50/60w	145 lm/w	30/40/50k	>80
LED-WPF-5P120-TRI-BZ-PC	120/277V	40/60/80/100/120w	145 lm/w	30/40/50k	>80
LED-WPF-5P60-TRI-BL-PC	120/277V	20/30/40/50/60w	145 lm/w	30/40/50k	>80
LED-WPF-5P120-TRI-BL-PC	120/277V	40/60/80/100/120w	145 lm/w	30/40/50k	>80
LED-WPF-5P60-TRI-WH-PC	120/277V	20/30/40/50/60w	145 lm/w	30/40/50k	>80
LED-WPF-5P120-TRI-WH-PC	120/277V	40/60/80/100/120w	145 lm/w	30/40/50k	>80

ACCESSORIES









Accessory Model	Description
WPF-SHIELD	Cut Off Shield for WPF Wall Packs
WPF-WG	Wire Guard for WPF Wall Packs

SENSORS

Pre-Installed Accessory Model	Description
Add '-BMS' to model #	S-BMS-EXT-1: Bi level motion + daylight sensor
Add '-BMS-BT' to model #	S-BMS-EXT-1-BT: Bi level motion + daylight sensor W/ bluetooth control (EnvisioLS App)
Add: -BMS-SIL to Model #	SILVAIR Enable Bluetooth Control: PIR/Daylight/Zoning/Monitoring

Control Options

EnVision LED offers 3 control systems compatible with our LED Fixtures for projects of all sizes and budgets.

	Basic Controls	EnVisionLS 	EnVisionLED.x SILVAIR 
Description	Standard Plug In Sensors	Basic Bluetooth Wireless Control	Advanced Bluetooth Wireless Control
Recommended Quantity (but not limited to)	N/A	>40-50 Nodes	>50 Nodes
Maximum Zone Quantity	N/A	100	3,000
Commissioning Tool	Remote Only	  ENVISIONLS App 	  SILVAIR App 
Commissioning Process	Individually Set via Remote	Wireless Must be done on site	Wireless- Initial linking must be done on site. Commissioning can be done via desktop remotely.
Floor Plan Upload	N/A	N/A	Yes Add a floor plan and mark luminaires & zones via desktop
Gateway	N/A	N/A	Required only for energy monitoring, advanced scheduling, automated demand response.
Individual Luminaire Control	Yes	Yes	Yes
Luminaire Grouping Zoning	N/A	Yes	Yes
High End Power Low End Power	Yes but limited (View Remote)	Yes	Yes
Cost	\$	\$\$	\$\$\$
DLC NLC Listed	N/A	Yes	Yes
Energy Monitoring & Data Reporting	N/A	N/A	Monitor energy usage per individual zone & retrofit cost savings calculation + detailed reporting



Compatible Products:

EnVision offers a variety of nodes, sensors, & gateways that are controlled via remote, ENVISIONLS Bluetooth Mesh & SILVAIR Bluetooth Mesh on all of our 0-10V dimmable fixtures.



Individual Fixture Controls: PIR Sensor, Bi-Level Dimming, Daylight

Basic Note: **-1** • ENVISIONLS Models Note: **-BT** • SILVAIR Models Note: **-SL**

	MODEL #	DESIGN	RECOMMENDED FIXTURE	FEATURES
	S-TWC-PIR-1 S-TWC-PIR-BT S-TWC-PIR-SL	Twist-C Control Sensor	Sensor Ready Fixtures: Area Lights, Canopies, Flood Lights, High Bays	All models are equipped with PIR occupancy sensing, high & low end bi-level dimming, & daylight sensing.
	S-TWC-90 + S-TWC-PIR-1 S-TWC-90 + S-TWC-PIR-BT S-TWC-90 + S-TWC-PIR-SL	Twist-C Control Sensor + 90 Degree Arm	Cylinders, Strips, Wall Packs	
	S-AUD-PIR-1 S-AUD-PIR-BT S-AUD-PIR-SL	2.5m Audio Jack	Panels & Troffers	
	S-SN-PIR-1 S-SN-PIR-BT S-SN-PIR-SL	Snap In Sensor	Troffers & Wraps	

Group Controls ENVISIONLS Models Note : **-BT** • SILVAIR Models Note: **-SL**

	MODEL #	DESIGN	VOLTAGE	FEATURES	RECOMMENDED FEATURES
	S-CM-PIR-LV-BT S-CM-PIR-LV-SL	Ceiling Mounted PIR Sensor	12-24V	PIR Sensor, Bi-Level Dimming, Daylight, 360° detection, 12' Max Mounting Height	Connects to 0-10V dimmable fixtures
	S-WM-PIR-CUNV-BT S-WM-PIR-CUNV-SL	Wall Mounted PIR Occupancy Sensor, Bi-Level Dimming, Daylight	120-277V	On/Off PIR occupancy sensor, 180° detection, 30' detection @ 4' Mounting Height	Connects to LED fixtures
	S-WS-120V-USB-SL		120V	Dimming Wall Socket, Two Sockets	Floor Lamps, Other Lamps

Gateway (Silvair Only) 4.5–5.5 V DC, 2A Power over Ethernet 36–57 V DC

	MODEL #	DESIGN	VOLTAGE	FEATURES	RECOMMENDED FEATURES
	SGW-102	Wall or Ceiling Mounted	POE	Advanced Energy Monitoring Control	Connects to Silvair Controls. Gateway is not required.