

ARCY-Line: Full Cut Off Wall Packs

3-CCT + 3-Power Selectable

Wall Packs



Downlight Application



Uplight Application

WATT	LUMENS
30	4,000
50	6,250
60	7,800
65	8,000
80	10,000
100	12,000

BUG CHART

	BUG
3P65: 30W	
3P65: 50W	
3P65: 65W	
3P100: 60W	B2-U0-G2
3P100: 80W	B2-U0-G2
3P100: 100W	B2-U0-G2

Detail Specifications:

- Finish: Bronze, Custom finishes available
- IP Rating: Wet Location IP66
- Impact Rating: IK08
- 3-CCT Selectable: 30/40/50K
- Beam Angle: Type III standard, IV or V available
- Chip: SMD 2835, R9 >50, CRI >80
- BUG:
 - 3P65:
 - 3P100:
 - 100W: B2-U0-G2
- Operating Temperature: -40° - 122° F
- Lens: Clear acrylic with optics
- Average life (L70) of 70,000 hours

Applications:

- Walkways & Pathways
- Parking Lots
- Hospitality, Multi-Family
- Outdoor Corridors
- Up or Down lighting
- Residential, Commercial and Industrial

Product Information:

- Sturdy die-cast aluminum housing finished with corrosion free powder coat
- Full Cut-Off Dark Sky Compliant when faced down
- -10° down to 20° up tilt adjustable design
- Fixture can be mounted faced up or down
- Photocell is included with an easy disconnect switch
- Instant-On to full brightness
- Select-n-Switch Technology: 3-CCT + 3-Power Selectable
- Control Options:
 - Standard Sensors
 - SILVAIR Bluetooth Mesh
 - ENVISIONLS Bluetooth
 - [Click Here](#) for More Information

Driver Options:

- UNV: 120-347V 0-10V Dimmable (Dim to off)
- Built in 6Kv Surge Protector
- THD: <20% (+/-5% tolerance), PF >0.9, 50/60Hz

Mounting & Installation:

- Mounts to junction box
- Conduit wall mount bracket available

Certifications:

- ETL Listed for USA and CA
- DLC Premium Listed
 - 3P65: S-WZJW3P
 - 3P100: S-74JL70
- ROHS Compliant
- Approved for CA T24
- 5 Year Limited Warranty
- FCC CFR 47, GCC Part 15, Subpart B:2017

Series	Finish ¹	Photocell	Voltage	Optic	Sensor ²	Emergency	Surge Protector
LED-WPFC-ARC-3P65-TRI 30/50/65W	BZ Bronze (Standard)	Photocell is included.	(Blank) 120-347V	(Blank) Type III	(Blank) No Sensor	(Blank) No	(Blank) 6KV
LED-WPFC-ARC-3P100-TRI 60/80/100W	BL Black	On/Off switch on fixture.	HV 277-480V	T4 Type IV	BMS Bi-Level Motion + Daylight Sensor	EMB Emergency	20KV 20KV
	WH White			T5 Type V	(S-BMS-EXT-1)	BackUp	Surge Protector
	GRY¹ Gray				BMS-BT PIR ENVISIONLS Bluetooth Control		
	CS¹ Custom Color				BMS-SL PIR SILVAIR Bluetooth Mesh		

¹. Standard quickship is bronze, black & white. Other colors are custom finishes

². Sensors require remote for programming

Optional Accessories (Order Separately)

Wall Mount Bracket (For Conduit Runs)	Remote for Sensors	Optic Lens
WPFC-ARC-JBOX-BZ Bronze	S-LINE-R S-Line Remote	WPFC-ARC-S-T-IV Type IV Optic 3P65 Model
WPFC-ARC-JBOX-BL Black		WPFC-ARC-S-T-V Type V Optic 3P65 Model
WPFC-ARC-JBOX-WH White		WPFC-ARC-M-T-IV Type IV Optic 3P100 Model
		WPFC-ARC-M-T-V Type V Optic 3P90 Model

Full Cut Off Wall Packs: ARCY-Line

3-CCT + 3-Power Selectable



DIMENSIONS

3P65

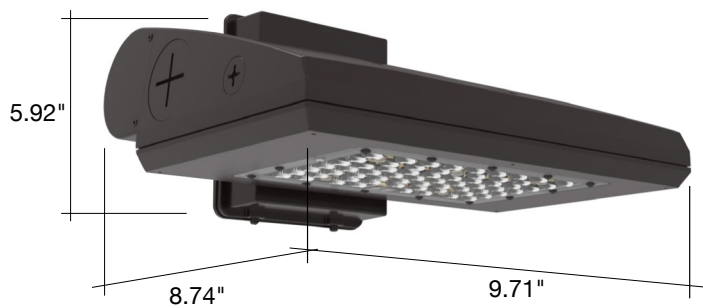

3P100

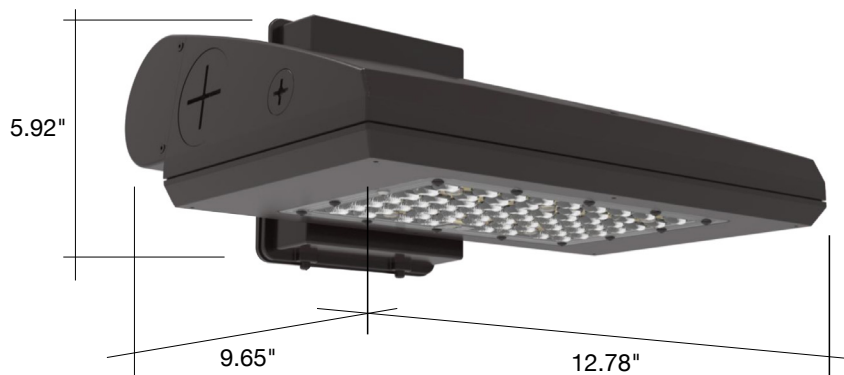

Full Cut Off Wall Packs: ARCY-Line

3-CCT + 3-Power Selectable



-JBOX-BZ

-JBOX-BL

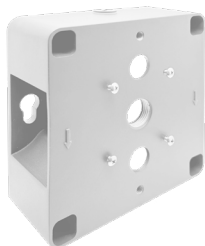

-JBOX-WH



BI-LEVEL MOTION



S-LINE-R

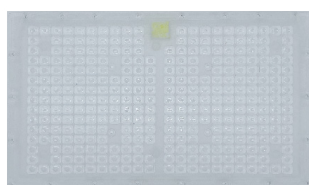

**TV
TIV**

Model	Voltage	Watts	Lumens	Color	CRI
LED-WPFC-ARC-3P65-TRI-BZ	120-347V	30/50/60w	145 lm/w	30/40/50k	>80
LED-WPFC-ARC-3P100-TRI-BZ	120-347V	60/80/100w	145 lm/w	30/40/50k	>80
LED-WPFC-ARC-3P65-TRI-BL	120-347V	30/50/60w	145 lm/w	30/40/50k	>80
LED-WPFC-ARC-3P100-TRI-BL	120-347V	60/80/100w	145 lm/w	30/40/50k	>80
LED-WPFC-ARC-3P65-TRI-WH	120-347V	30/50/60w	145 lm/w	30/40/50k	>80
LED-WPFC-ARC-3P100-TRI-WH	120-347V	60/80/100w	145 lm/w	30/40/50k	>80

SENSORS

Model	Item Description	Voltage	Watts
S-BMS-EXT-1	S-Line: Bi Level Motion Sensor w/ Daylight Harvesting, Ideal for use with LED WALLPACKS. 12V Aux REQD. (Remote Required)	12V	<1w
S-BMS-EXT-1-BT	S-Line: Bi Level Motion Sensor w/ Daylight Harvesting, Ideal for use with Wallpacks. 12V Aux REQD. (Remote Required)	12V	<1w

WALL MOUNT BRACKET

Accessory Model	Description
WPFC-ARC-JBOX-BZ	WPFC-ARC : Wall Mount Bracket for conduit runs
WPFC-ARC-JBOX-BL	WPFC-ARC : Wall Mount Bracket for conduit runs
WPFC-ARC-JBOX-WH	WPFC-ARC : Wall Mount Bracket for conduit runs

SENSORS

Pre-Installed Accessory Model	Description
Add '-EMB' to model #	Emergency backup (internal 8W)
Add '-BMS' to model #	S-BMS-EXT-1: Bi level motion + daylight sensor
Add '-BMS-BT' to model #	S-BMS-EXT-1-BT: Bi level motion + daylight sensor W/ bluetooth control (EnvisioNLS App)
Add: -BMS-SIL to Model #	SILVAIR Enable Bluetooth Control: PIR/Daylight/Zoning/Monitoring
Add: 20KV to model#	SG-20KV-UNV: 20KV surge protector
Add: -T4 to Model #	Factory installed type IV
Add: -T5 to Model #	Factory installed type V

REMOTE

Accessory Model	Description
S-LINE-R	Remote for S-LINE Series Sensors

OPTIC LENS

Accessory Model	Description
WPFC-ARC-S-T-IV	Type IV Optic 3P65 Model
WPFC-ARC-S-T-V	Type V Optic 3P65 Model
WPFC-ARC-M-T-IV	Type IV Optic 3P100 Model
WPFC-ARC-M-T-V	Type V Optic 3P90 Model









TESTED COMPATIBLE DIMMERS

Compatible 0-10V Dimmer List

Lithonia	Cooper	Lutron	Leviton
ISC BC 120/277 WH	SF10P-W	DVSTV-WH	IP710-DLZ

Control Options

EnVision LED offers 3 control systems compatible with our LED Fixtures for projects of all sizes and budgets.

	Basic Controls	EnVisionLS 	EnVisionLED.x SILVAIR 
Description	Standard Plug In Sensors	Basic Bluetooth Wireless Control	Advanced Bluetooth Wireless Control
Recommended Quantity (but not limited to)	N/A	>40-50 Nodes	>50 Nodes
Maximum Zone Quantity	N/A	100	3,000
Commissioning Tool	Remote Only	  ENVISIONLS App 	  SILVAIR App 
Commissioning Process	Individually Set via Remote	Wireless Must be done on site	Wireless- Initial linking must be done on site. Commissioning can be done via desktop remotely.
Floor Plan Upload	N/A	N/A	Yes Add a floor plan and mark luminaires & zones via desktop
Gateway	N/A	N/A	Required only for energy monitoring, advanced scheduling, automated demand response.
Individual Luminaire Control	Yes	Yes	Yes
Luminaire Grouping Zoning	N/A	Yes	Yes
High End Power Low End Power	Yes but limited (View Remote)	Yes	Yes
Cost	\$	\$\$	\$\$\$
DLC NLC Listed	N/A	Yes	Yes
Energy Monitoring & Data Reporting	N/A	N/A	Monitor energy usage per individual zone & retrofit cost savings calculation + detailed reporting







Compatible Products:

EnVision offers a variety of nodes, sensors, & gateways that are controlled via remote, ENVISIONLS Bluetooth Mesh & SILVAIR Bluetooth Mesh on all of our 0-10V dimmable fixtures.





Individual Fixture Controls: PIR Sensor, Bi-Level Dimming, Daylight

Basic Note: **-1** • ENVISIONLS Models Note: **-BT** • SILVAIR Models Note: **-SL**

	MODEL #	DESIGN	RECOMMENDED FIXTURE	FEATURES
	S-TWC-PIR-1 S-TWC-PIR-BT S-TWC-PIR-SL	Twist-C Control Sensor	Sensor Ready Fixtures: Area Lights, Canopies, Flood Lights, High Bays	All models are equipped with PIR occupancy sensing, high & low end bi-level dimming, & daylight sensing.
	S-TWC-90 + S-TWC-PIR-1 S-TWC-90 + S-TWC-PIR-BT S-TWC-90 + S-TWC-PIR-SL	Twist-C Control Sensor + 90 Degree Arm	Cylinders, Strips, Wall Packs	
	S-AUD-PIR-1 S-AUD-PIR-BT S-AUD-PIR-SL	2.5m Audio Jack	Panels & Troffers	
	S-SN-PIR-1 S-SN-PIR-BT S-SN-PIR-SL	Snap In Sensor	Troffers & Wraps	

Group Controls ENVISIONLS Models Note : **-BT** • SILVAIR Models Note: **-SL**

	MODEL #	DESIGN	VOLTAGE	FEATURES	RECOMMENDED FEATURES
	S-CM-PIR-LV-BT S-CM-PIR-LV-SL	Ceiling Mounted PIR Sensor	12-24V	PIR Sensor, Bi-Level Dimming, Daylight, 360° detection, 12' Max Mounting Height	Connects to 0-10V dimmable fixtures
	S-WM-PIR-CUNV-BT S-WM-PIR-CUNV-SL	Wall Mounted PIR Occupancy Sensor, Bi-Level Dimming, Daylight	120-277V	On/Off PIR occupancy sensor, 180° detection, 30' detection @ 4' Mounting Height	Connects to LED fixtures
	S-WS-120V-USB-SL		120V	Dimming Wall Socket, Two Sockets	Floor Lamps, Other Lamps

Gateway (Silvair Only) 4.5–5.5 V DC, 2A Power over Ethernet 36–57 V DC

	MODEL #	DESIGN	VOLTAGE	FEATURES	RECOMMENDED FEATURES
	SGW-102	Wall or Ceiling Mounted	POE	Advanced Energy Monitoring Control	Connects to Silvair Controls. Gateway is not required.