

LED Wrap Fixture Installation Instructions

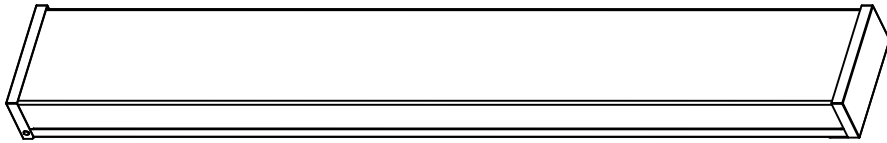

LED WRAP FIXTURE (Prismatic Lens)

LED-WRP-PRM-2FT-20W-XXK

LED-WRP-PRM-4FT-40W-XXK

PLANNING INSTALLATION

- Turn off the electrical power at the fuse or circuit breaker box before installing or servicing any part of this fixture.
- If replacing a fixture, remove existing fixture and make a sketch of wiring configuration (by color) or mark wires with masking tape for identification.
- Remove the lamp base and diffuser from the carton and check that all parts are included. Be careful not to misplace any of the screws or parts needed for installing the fixture.
- Diffuser is fragile. Carefully set aside in a safe location to avoid damage until ready to be installed.

HARDWARE INCLUDED

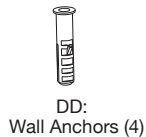
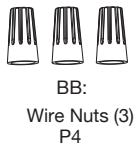
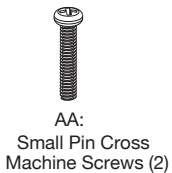

PARTS

A - Lamp Base

B - Diffuser

C - Pull out to remove end cap

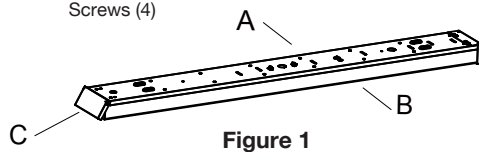
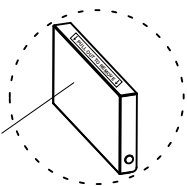

Remove diffuser (Part B) from lamp base (Part A) - Pull out to remove end cap (Part C) out from the lamp base (Part A), then dig out the diffuser (Part B).

CAUTION: Before beginning installation turn off the circuit breaker and light switch.

IMPORTANT: Depending on the type and orientation of junction box it may be necessary to use the keyhole installation method to achieve the desired fixture orientation within the room

JUNCTION BOX INSTALLATION

1. Install the two screws (AA) into the junction box. (Figure 2)

NOTE: Leave 1/4" of screw exposed to accommodate lamp base.

2. Use a screwdriver to punch out one of the knocked holes (Figure 3) and take out the cables from the lamp base.

3. Remove the heat shrink tubing wrap from the ends of the black, white, and green wires in order to expose the copper wires prior to connect the AC wires to the corresponding wires (BLACK to BLACK, WHITE to WHITE and GREEN to GREEN) in the junction box and secure using wire nuts (Part CC).

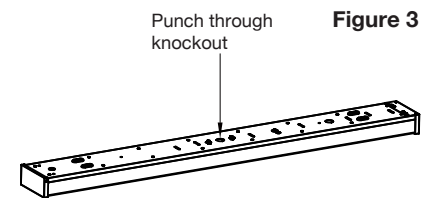
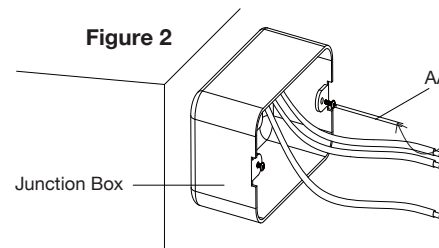

NOTE: 1. For proper connection, place the wire nuts (BB) over wires and twist clockwise until tight. (Figure 4)

OPTIONAL: Wrap connected wire nuts with electrical tape.

2. Do not perform this step if you are using this light as a linked light.

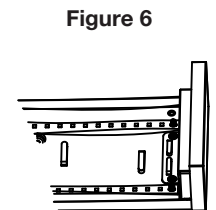
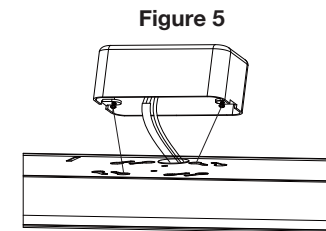
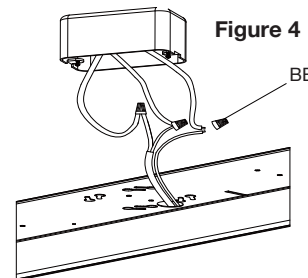

ATTACHING LAMP BASE

1. Attach the Lamp Base to the junction box by aligning the holes on the Lamp Base (Part A) with the screws on the junction box.
2. Turn Lamp Base clockwise to lock in place and tighten screws to ensure the fixture is secure and will not move. (Figure 5)

ATTACHING THE DIFFUSER

To install diffuser (B) - starting at one end of lamp base, insert diffuser slot onto edge of lamp base - See Figure 6. Carefully squeeze diffuser to engage opposite side with lamp base. Continue this action down length of diffuser until fully installed onto lamp base. (Figure 6). Turn on breaker and test light function.

KEYHOLE INSTALLATION

1. Use a screwdriver to punch out one of the knocked holes (Figure 7) and take out the cables through the the cables through the knockout hole from the housing.
2. Align knockout hole with the supply wire location on the mounting location with one hand while marking the location of the four keyhole slots at each end of the housing. (Figure 8)

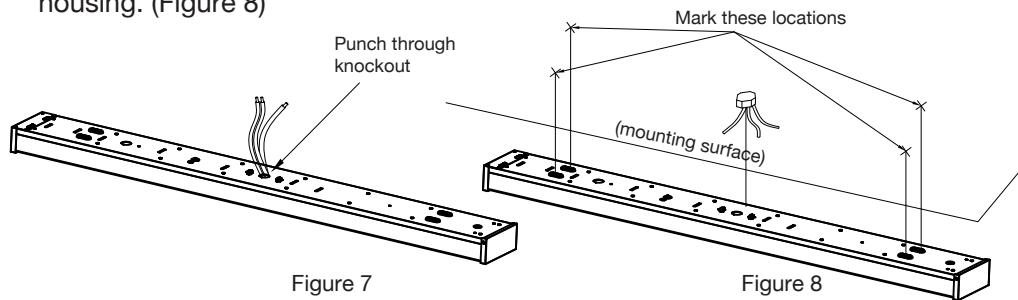

Figure 7

Figure 8

Drywall Mounting:

If the mounting holes go through drywall without a stud, drill four small pilot holes by a 1/8" drill bit (not included) and install wall anchors (DD) into the holes with a hammer (not included). Install the four wood screws (CC) into the mounting surface but leave about a 3/8" gap between the screw head and mounting surface.

Wall Setup Mounting:

If the mounting holes go through wall studs, drill four small pilot holes using a 5/32" drill bit (not included) for the wood screws (CC). Install the four wood screws (CC) into the mounting surface but leave about a 3/8" gap between the screw head and mounting surface. (Figure 9)

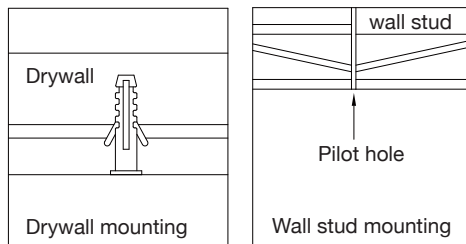

Figure 9

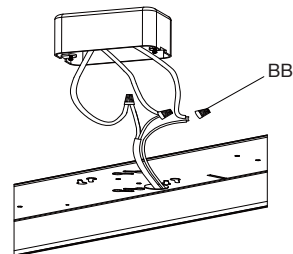

Figure 10

3. Remove the heat shrink tubing wrap from the ends of the black, white, and green wires in order to expose the copper wires prior to connect the AC wires to the corresponding wires (BLACK to BLACK, WHITE to WHITE and GREEN to GREEN) in the junction box and secure using wire nuts (Part BB). (Figure 10)

NOTE: - For proper connection, place the wire nuts (BB) over wires and twist clockwise until tight. (Figure 10)

OPTIONAL: Wrap connected wire nuts with electrical tape.

- Do not perform this step if you are using this light as a linked light.

4. Hide cables with wire nuts in the junction box. Guide the heads of the four wood screws into the keyhole slots and slide the lamp base (A) in the direction such that the wood screw heads rest over the narrow part of the keyhole slot. Ensure that the fixture is supported and tighten the four wood screws until the fixture is secured to the mounting surface. (Figure 11)
5. To install diffuser (B) - starting at one end of lamp base, insert diffuser slot onto edge of lamp base. See Figure 12. Carefully squeeze diffuser to engage opposite side with lamp base. Continue this action down length of diffuser until fully installed onto lamp base (Figure 12). Turn on breaker and test light function.

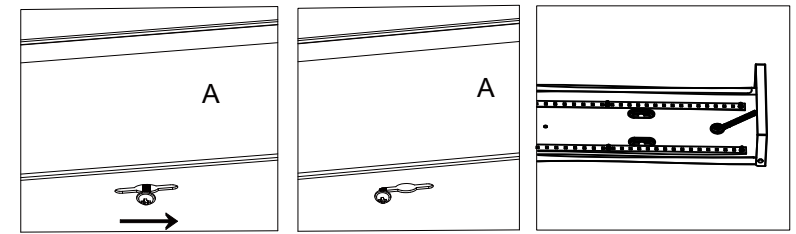

Figure 11

Figure 12