

# LED High Bay Installation Instructions

## CAUTION:

1. Can not use the electric generator to test the LED light.
2. Please abide by related country, regional and local law and regulation when installing this fixture.
3. Please turn off the power before installation or maintenance.
4. Proper grounding is required to ensure safety.

## NOTICE:

1. To avoid possibility of electrical shock or fire, the installation personnel must have professional electric knowledge.
2. Please wear gloves to avoid injury before installation.
3. If there is any smoke or spark, please turn off the power immediately and consult a qualified electrician.
4. Please use listed water proof strain relief bushing when connecting the supply cord to the outlet box.

## ATTENTION:

1. Please check if there is any damage during shipping. If so, please contact manufacturer in a timely manner.
2. Please read the installation instructions carefully to check whether all accessories are complete.  
After confirmation, install the fixture according to installation steps.

### WIRING DIAGRAM & INSTRUCTIONS:

This LED highbay light can be equipped with optional DC motion sensor and is available with 0/1-10V dimming function, with following 3 dimming solutions:

1. 0/1-10V dimming
2. Intelligent dimming with DC motion sensor
3. Pre-install tool-free handling DC motion sensor dimming module, and choose dimming module, and choose dimming function.

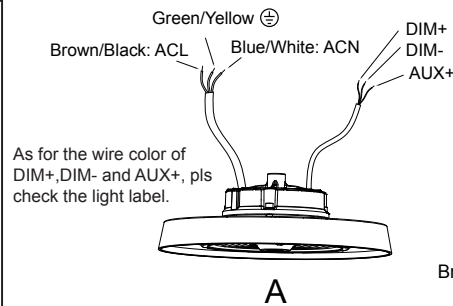

Description:	
This product is 0/1-10V dimming, below dimmers are recommended:	
Brand	Model
LUTRON	NTSTV-DV
LEVITON	DS710 / IP710
LEGRAND	RH4FBL3PTC

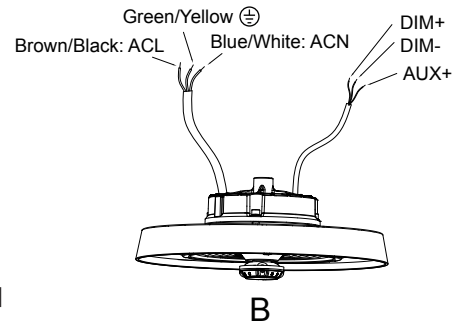

**Installation Methods: Hook Mount, Ceiling Mount, 1/2" NPT Mount.**  
(Please choose the most suitable installation method for the purchased product per your needs)

### HOOK MOUNT:

1. Screw the hook into the fixture, tighten and secure it. (Figure 1)
2. Hang the fixture on the ceiling hook or chain. (Figure 2)
3. After installation, connect the wire of the fixture to the main connection according to local wiring rules, ensure the connection is stable and protected on the connection.

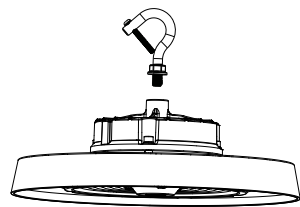
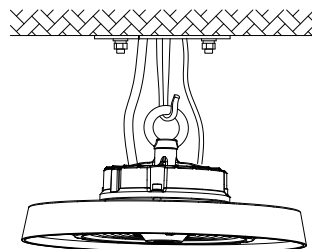
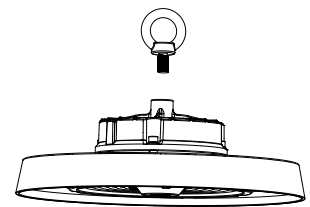
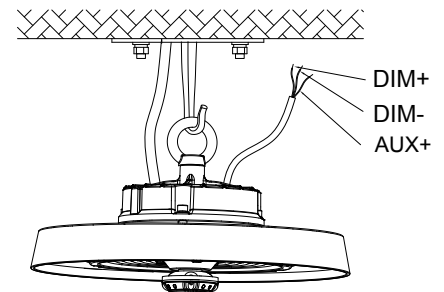

FIGURE 1



A



B

FIGURE 2

## CEILING MOUNT:

1. Mark with a marker pen or sharpie tool on the mounting surface and drill. (Figure 3)
2. Fix screws into the holes with a hammer. (Figure 4)
3. Align the bracket hole with screw hole (Figure 5), and push the fixture to one side (Figure 6) and fix it.
4. After installation, connect the wire of the fixture to the mains according to local wiring rules, ensure the connection is stable and protected on the connection. By adjusting the brackets screws, users can adjust 50° to the left or right vertically. (Figure 7)

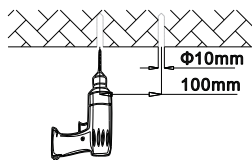

FIGURE 3

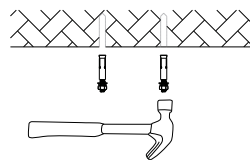

FIGURE 4

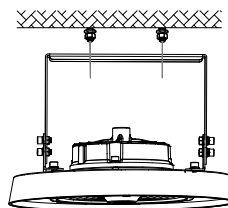

FIGURE 5

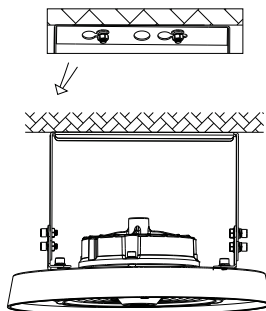

FIGURE 6

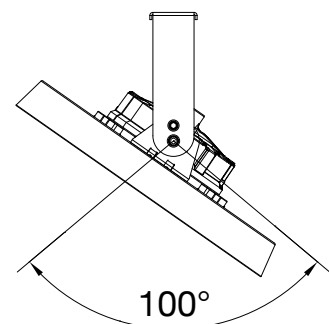

FIGURE 7

## 1/2" NPT MOUNT:

1. Unscrew the nuts on 1/2" NPT. (Figure 8)
2. Insert 1/2" NPT stem into the bracket hole. (Figure 9)
3. Re-screw the nuts. (Figure 10)
4. After installation, connect the wire of the fixture to the main according to local wiring rules, ensure the connection is stable and make good protection on the connection. By adjusting the brackets screws, users can adjust 50° to the left or right vertically. (Figure 11)

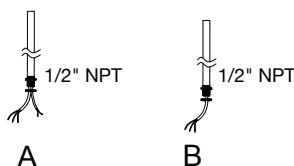

FIGURE 8

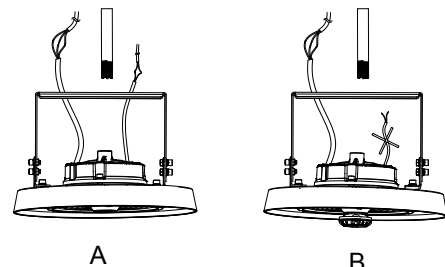

FIGURE 9

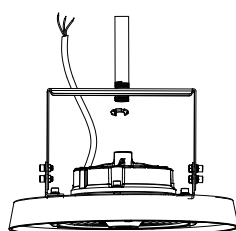

FIGURE 10

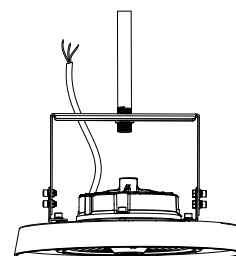

FIGURE 11

## INSTALLATION OF DC MOTION SENSOR

1. With 1/2NPT interface, it is available to replace of different functional devices according to your needs by using a screwdriver, see the schematic diagram for details.
2. The fixture is default to come with 1/2 plug. Motion sensor and PIR sensors are optional accessories. Choose to use according to your needs.
3. Default programs have been set for motion sensor and PIR before shipment, it needs to be re-set by a remote control if you need to change the working mode and the remote control is an optional accessory. (Figure 12)

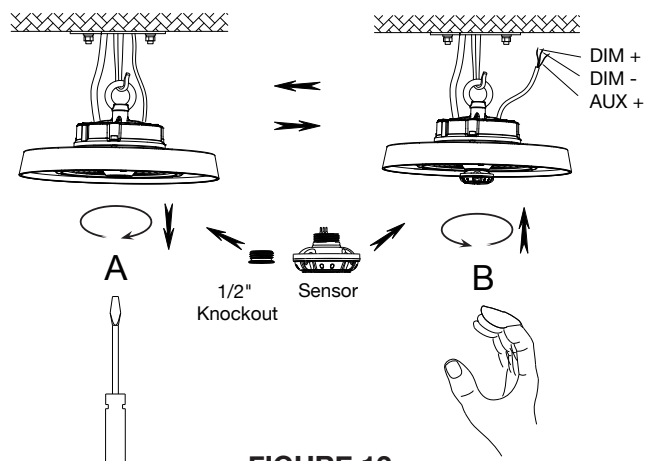

FIGURE 12