

# Emergency Battery Backup Installation Instructions



## TOOLS AND MATERIALS REQUIRED:



Phillips Screwdriver

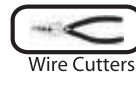

Wire Cutters



Pliers



Wrench

Wiring supplies as required by the Canadian Electrical Code and/or the Quebec Electrical code

## SAFETY RECOMMENDATIONS

1. The lighting shall be mounted at a height of maximum 4.0m.
  2. Do not use outdoors.
  3. Do not mount near gas or electric heaters. Do not let power supply cords touch hot surfaces.
  4. Use caution when changing batteries -TURN ALL POWER OFF, BOTH WALL SWITCH AND MAIN POWER! Use only designated battery as supplied with original unit or as listed for use with this product. Dispose of old battery in designated disposal location.
  5. Equipment should be mounted in locations and at heights where it will not be subjected to tampering by unauthorized personnel.
  6. This product is designed for use with the 7" Round or 7" Square Blink Pop "n" lock series lighting. Must not be used with any other fixture.
  7. Do not use this product for other than intended use.
- All serving should be performed by professional personnel.

SAVE THESE INSTRUCTIONS

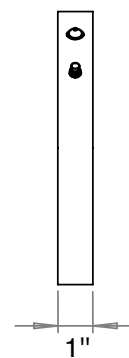
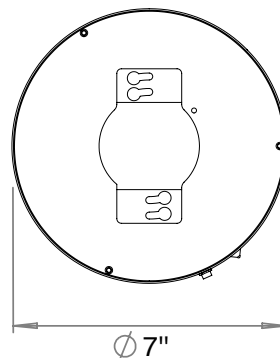
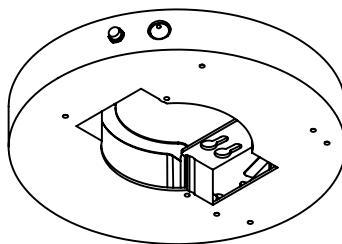

## Test Button and LED Indicator

Test Button functions

### 1. While main power is on:

A quick press of the test button, (<3seconds), simulates the "main power outage" or emergency mode"

The light fixture will come on, in this case it will be running on battery power.

Pressing test button for 3-6 seconds puts the unit into the monthly self-check routine (approx. 3 minutes run time).

Press test button again anytime to stop the routine.

As the system runs its check on the battery power and circuit connections, the LED indicator will flash green @ 1 cycle/second.

Pressing test button for > 6 seconds puts the unit into the annual self-check routine. (up to 90 minutes run time)

**Note: The system will completely discharge the battery during this routine).**

Press test button again anytime to stop the routine.

As the system runs its more detailed annual check on the battery power and circuit connections,

the LED indicator will quickly flash green @ 3 cycle/second .

### 2. While in Emergency Status (mains power outage):

Pressing test button for <6 seconds shuts off the unit. Press again to turn it back on.

Pressing test button for >6 seconds completely shuts off emergency output. In this state, the system will not function unless the main power is reset.

## LED indicator colors/functions

Red: Battery is charging.

Green: Battery at full charge.

Yellow: Check system- possible battery replacement needed or system maintenance required.

Green Flashing: Monthly or annual checking mode is running.

Off: Indicates a power outage. When the Battery Backup unit is in Emergency Mode the LED indicator will be Off.

Minimum charge time: 24hours.

# Slim Surface Light

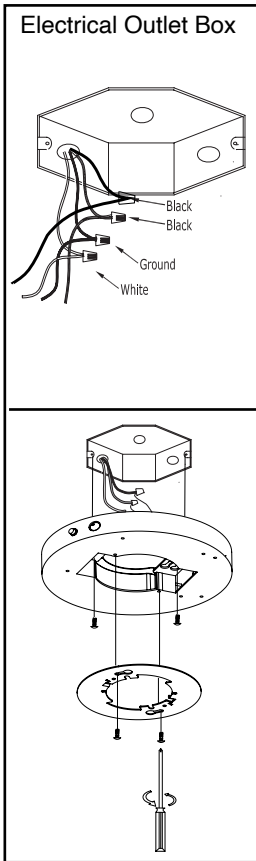

**Step 1** Turn Off/Disconnect power at Circuit breaker. Typical junction box wiring has only white & black switched wires controlled by wall switch for on/off or dimming. Ensure the junction box has an additional set of UNSWITCHED WIRES (continuous) main power wires available. If necessary, add these wires as shown. (Label these additional wires on correct connections.

**Step 2** Screw the Emergency Backup unit up into the junction box using the 2X8/32 screws provided. Then using the wire provided, connect the three (3) cables available for connection into junction box.

- Connect the "Switched Line" to the black switched power cable coming from the junction box.
- Connect the "Continuous Mains Power" from the battery backup box to the continuous mains black wire from the junction box.
- Connect the "Neutral" white wire from the battery backup together with the other two neutral white wires coming

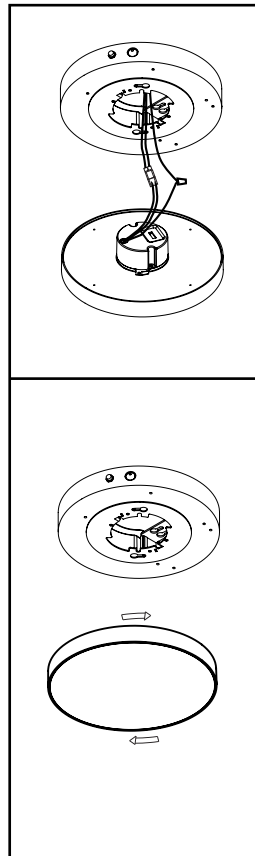

**Step 3** Make electrical connections from the Bilnk LED lighting fixture with the battery backup.

- Use the orange connector already supplied and affixed to the unit.
- Be sure to connect the ground wire coming from the lighting fixture.

**Step 4** Pop n lock into place

- Feed all wires up into the battery backup box and raise the lighting fixture up to the ceiling.
- Align the edge of the fixture with the ball bearings on the mounting bracket and Pop n lock into place.

## FOR CONTINUOUS POWER APPLICATIONS

If the battery backup is used for

1. A system with 24/7 lighting OR
2. As a dedicated Emergency Lighting only, (light off in normal condition)

Only continuous UNSWITCHED power is needed at the junction box-no need for switched wires.

### Option 1

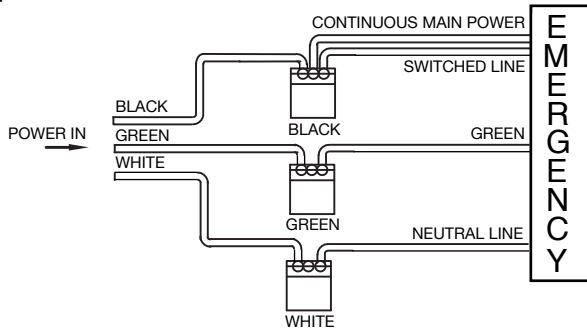

For Option 1 above as 24/7 lighting: Connect the two black wires (labeled as "Continuous Main Power" and "Switched Line") from the battery backup to the black main wire in the junction box and connect the white ("Neutral") to white from the box wires.

Then screw the Emergency Backup unit up into the junction box using the 2 x 8/32 screws provided go to STEP 4

### Option 2

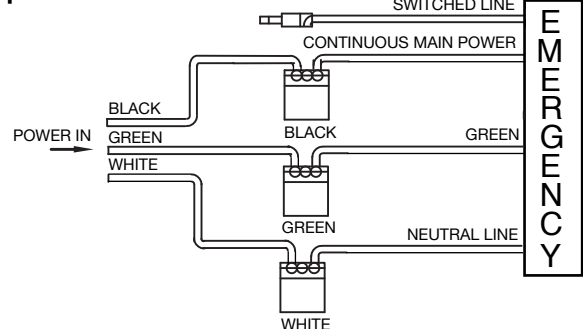

For Option 2 above as dedicated Emergency Light only: Connect the black wire (labeled as "Continuous Main Power" from the battery backup to the black mains wire in the junction box and Connect white ("Neutral") to white from the battery backup fixture to junction box wires (image below). Screw wire nut over the "Switched Line" and leave unconnected. Then screw the Emergency Backup unit up into the junction box using the 2 x 8/32 screws provided the go to STEP 4.